

LASERS

Laser an acronym for light amplification by stimulated emission of radiation.

In 1958 Schawlow and Townes put forward the idea of constructing a laser using the process of stimulated emission.

In 1960 Maiman of Hughes Research Laboratory obtained pulsed laser action at 6943 \AA in the Red region of the spectrum using a ruby crystal as the active medium.

Characteristics of laser

1. Directionality: **The laser beam is highly directional.** For example a laser beam ray 10 cm in diameter when beamed at the moon surface, which is 3,84,000 km away is not more than 5 km wide. A conventional light source emits light in all directions due to spontaneous emission. **Due to stimulated emission of radiation the laser light is highly directional.** The directionality is measured in angular divergence $\Delta\theta$. The laser light of wavelength λ emerges through a laser source of aperture diameter d , then it propagates as a parallel beam up to $\frac{d^2}{\lambda}$ and gets diverged.

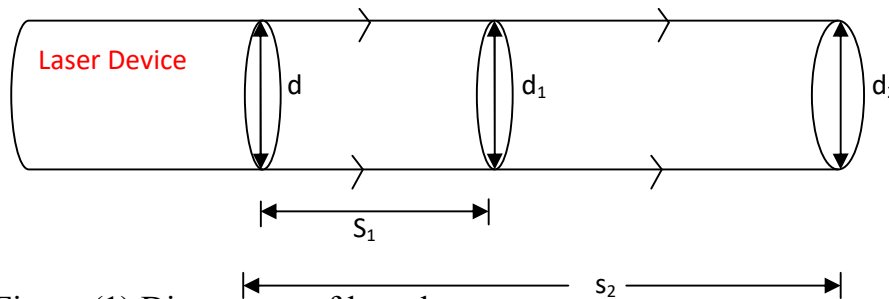

Figure (1) Divergence of laser beam

$$\Delta\theta = \frac{d_2 - d_1}{s_2 - s_1}$$

Where d_2 and d_1 are the diameters of the laser beam spots at distances of s_2 and s_1 respectively from the laser source.

For a laser beam $\Delta\theta = 10^{-3}$ radians.

The spread in laser beam is less than **0.01 mm** for a distance of 1 m.

2. Monochromaticity:

The laser light is highly mono chromatic i.e. the output light is having only one single color or single wavelength.

The spread in spectral width is very narrow. In a laser, all the photons emitted between discrete energy levels and hence they have same wavelength. Let the spread in frequency be $\nu + \Delta\nu$.

The spread in frequency $\Delta\nu$ is related to its wavelength spread $\Delta\lambda$ as

$$\Delta\lambda = \left[\frac{C}{\nu^2} \right] \Delta\nu$$

For a laser, $\Delta\lambda = 0.001nm$. Hence a laser light is highly mono chromatic.

Also for a stable laser $\Delta\nu = 50Hz$ and $\nu = 5 \times 10^{14} Hz$

For any laser $\frac{\Delta\nu}{\nu}$ or $\frac{\Delta\lambda}{\lambda}$ is very small.

\therefore The degree of non-monochromaticity $\varepsilon = \frac{\Delta\nu}{\nu}$

$$\varepsilon = \frac{50}{5 \times 10^{14}} = 10^{-13}$$

\therefore The laser is highly monochromatic.

For a conventional sodium monochromatic source of light, the degree of non-chromaticity is about 10^{-13} .

3. Coherence

Laser light is highly coherent i.e. the light waves coming from the laser source will be in phase or will have a constant phase difference over a period of time and space.

Coherence is the prediction of amplitude and phase at any point on the wave knowing the amplitude and phase at any other point on the same wave.

If laser light is to be coherent, it should be temporally coherent and spatially coherent.

Temporal coherence

Temporal coherence is the ability to predict amplitude and phase over a period of time Δt between initial and final observations.

In this time interval the wave train must maintain a constant phase difference. Longer this time, greater is the coherence.

Here amplitude and phase can be predicted at a point on the wave with respect to another point on the same wave over a period of time Δt .

For a laser radiation, all the emitted photons are in phase, the resultant radiation will have temporal coherence.

Spatial coherence

The relative phases between two points in space, on the wave front must remain constant over some long interval of time.

The spatial coherence refers to the correlation of phase between two light waves at two different points in space. They will maintain a constant phase

difference over a period of time Δt , and then they are said to be spatially coherent. For higher coherence $\frac{\Delta \nu}{\nu}$ must be small.

4. Intensity

In a laser beam more light energy is concentrated in a small region. The concentration of energy exists both spatially and spectrally. Therefore high intensity for laser beam. Now let there be 'n' number of coherent photons of amplitude 'a' in the emitted laser radiation. These photons combine together and the amplitude of the resulting wave becomes na.

Since the intensity is proportional to $n^2 a^2$ [Intensity \propto (Amplitude)²], the laser light will have high intensity.

The number of photons delivered from a laser per second per unit area is given by

$$N_l = \frac{P}{h\nu\pi r^2} \approx 10^{22} - 10^{34} \text{ Photons } m^{-2}s^{-1}$$

Here $h\nu = 10^{-19}$ Joule, Power $p = 10^{-3} - 10^9$ W

Radius $r = 0.5 \times 10^{-3}$ m

According to Planck's theory of Black body radiation, the number of photons emitted per second per unit area by a body with a temperature T is given by

$$N_0 = \frac{2\pi C}{\lambda^4} \frac{1}{\left[e^{\frac{hc}{\lambda T}} - 1 \right]} d\lambda = 10^{16} \text{ Photons } m^{-2}s^{-1}$$

Here $T = 1000^{\circ}\text{K}$, $\lambda = 6000 \text{ \AA}$

This shows that laser is highly intense.

5. Brightness

Laser light will have higher brightness.

This is due to the fact that laser light is highly intense, temporally coherent and spatially coherent.

Spontaneous and stimulated emission of radiation

When the incident Radiation (Photons) interacts with the atoms in the energy levels then three distinct processes can take place.

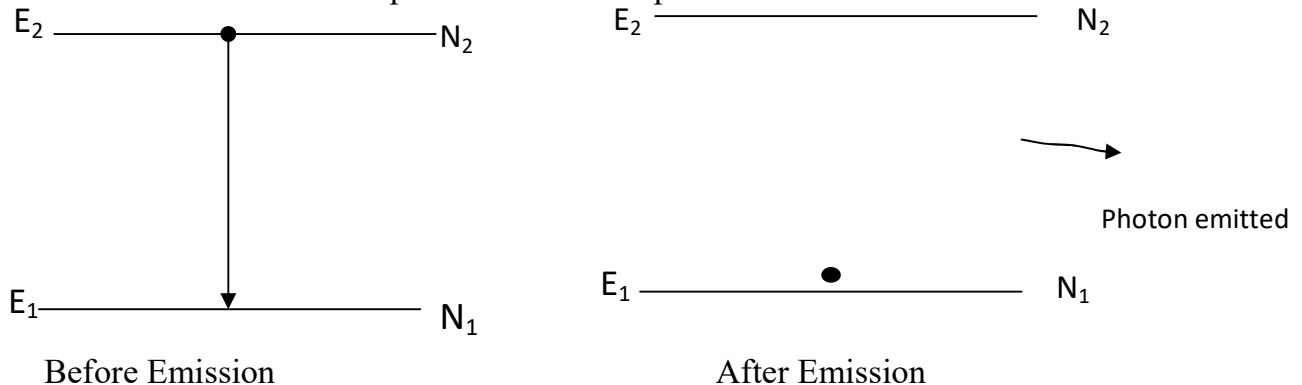

Figure (2) spontaneous emission

Consider a two level energy system. The energies of the levels are E_1 and E_2 . Here $E_2 > E_1$.

The population of the energy levels E_1 and E_2 are N_1 and N_2 . This is shown in figure (2).

The excited atoms in the higher energy level can stay up to 10^{-8} seconds. This is called life time.

The life time of an atom is the average time it exists in an excited state before it makes spontaneous transition to a lower energy state.

Immediately, after the life time of the excited atoms it makes a transition to the lower energy level E_1 by emitting a photon. Energy of the emitted photon is

$$E_2 - E_1 = h\nu, \quad \nu = \frac{E_2 - E_1}{h}$$

The process of emission of radiation by the transition of an excited atom to the lower energy level on its own is known as spontaneous emission.

The no. of spontaneous emissions $\propto N_2$

The no. of spontaneous emissions = $A_{21}N_2$

Where A_{21} is a constant of proportionality known as Einstein's A coefficient of spontaneous emission.

Stimulated absorption

Let us consider a two level energy system with energies E_1 and E_2 . Here $E_2 > E_1$.

Let N_1 and N_2 are the populations of the energy levels E_1 and E_2 . This shown in the figure (3).

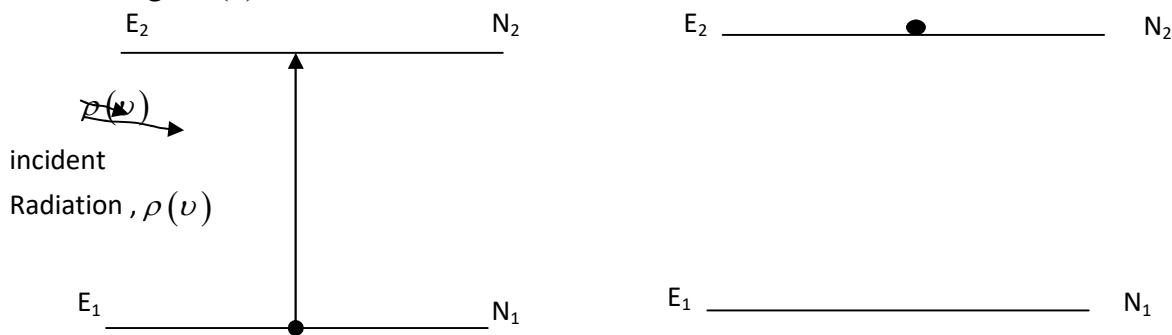

Fig. 3(a) Before absorption

b) After absorption

Fig (3) Stimulated Absorption

The incident radiation consists of photons of energy equal to the energy difference between E_1 and E_2 .

The number of photons per unit volume of incident radiation is known as Radiation density $\rho(\nu)$.

The incident photons interact with the atoms present in the lower energy level E_1 . The energy of photons is absorbed by the atoms in E_1 . After absorbing energy the atoms make a transition to the upper energy level E_2 .

This process of exciting the atoms to higher energy level by the absorption of stimulating incident photons energy is known as stimulated absorption of radiation

The number of stimulated absorptions depend upon the number of atoms per unit volume N_1 in E_1 and the incident radiation density $\rho(\nu)$

$$\begin{aligned} \text{Number of stimulated absorptions} & \propto N_1 \\ & \propto \rho(\nu) \\ & \propto N_1 \rho(\nu) \\ & = B_{12} N_1 \rho(\nu) \end{aligned}$$

Where B_{12} is a constant of proportionality known as Einstein's B coefficient for stimulated absorption of radiation.

If the atoms are excited from E_1 to E_2 , makes a transition to lower energy level E_1 , then radiation is emitted.

The emission of radiation takes place in two forms one spontaneous emission and Second stimulated emission.

Stimulated emission

When a photon having energy equal to the energy difference between the two energy levels interacts with the atom in the upper state and causes it to change to the lower state with the creation of a second photon. This process is converse of absorption. This is known as stimulated emission of Radiation.

This is shown in figure (4).

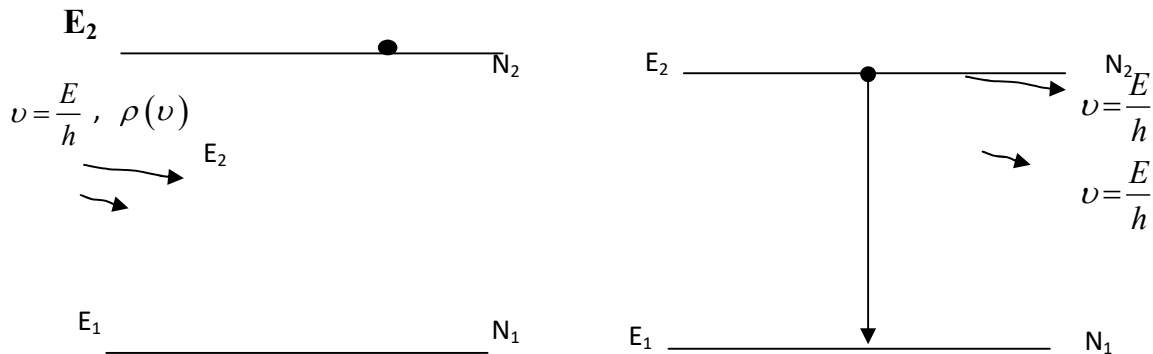

Figure 4(a) Before emission

4 (b) After emission

Figure (4) stimulated emission

During the transition a photon is emitted out in addition to the incident photon.

The frequency of emitted photons will have $\nu = \frac{E_2 - E_1}{h}$, $E_2 - E_1 = h\nu$

The number of stimulated emissions depends on the number of atoms in the energy level E_2 i.e. N_2 and the radiation density of incident photons $\rho(\nu)$

Number of stimulated emissions $\propto N_2$

Number of stimulated emissions $\propto \rho(\nu)$

Number of stimulated emissions $\propto N_2 \rho(\nu)$

Number of stimulated emissions = $B_{21} N_2 \rho(\nu)$

B_{21} is a constant of proportionality.

B_{21} is known as Einstein's B coefficient for stimulated emitted of radiation.

The following are the two important points.

- 1) The photons produced by stimulated emission is of almost equal energy to that which caused stimulated emission.

Here the light waves associated with them must be of nearly the same frequency.

- 2) The light waves associated with the two photons are in phase, they are said to be coherent.

Difference between spontaneous emission and stimulated emission

Spontaneous emission	Stimulated emission
<ol style="list-style-type: none"> 1. This was proposed by Neil's Bohr. 2. Incoherent radiation. 3. Less intensity 4. Polychromatic radiation. 5. Emission of light photon takes place immediately (10^{-8} sec) without any inducement during the transition of atoms from higher energy level to lower energy level. 6. Less directionality. 7. More angular spread during propagation Ex. Light from a sodium or mercury vapor lamp. 8. Denoted with A_{21} Einstein's Coefficient 	<ol style="list-style-type: none"> 1. This was proposed by Einstein. 2. Coherent radiation 3. High intensity 4. Highly monochromatic radiation. 5. Emission light photon takes place by inducement. A photon having energy equal to the energy difference between two energy levels interacts with the atom in the upper level and causes it to make a transition to the lower energy level. 6. High directionality. 7. Less angular spread during propagation. Ex. Light from a laser source. 8. Denoted with B_{21} Einstein's Coefficient

Population inversion

Consider a two level energy system. Also consider that there are N atoms per unit volume exist in a given energy state.

This N is known as population and is given by

Boltzmann’s equation

$$N = N_0 e^{-E/KT} \text{ ----- (1)}$$

$$N_2 \text{-----} E_2$$

$$N_1 \text{-----} E_1$$

A two level system.

Where N_0 = Population in the ground state

K= Boltzmann’s constant

T= Absolute temperature

And E= Energy of the level with population N.

From the above it is clear that population is the maximum in the ground state.

Population decreases exponentially as we go to higher energy states.

This exponential decrease is shown in figure (5).

i.e. At the ground level the population is high and at the higher level population is low.

Let N_1 = population in the energy state E_1 .

N_2 = Population in the energy state E_2 .

Note that $E_2 > E_1$.

From Boltzmann’s law, we have

$$N_2 = N_0 e^{-E_2/KT} \text{ -----(2)}$$

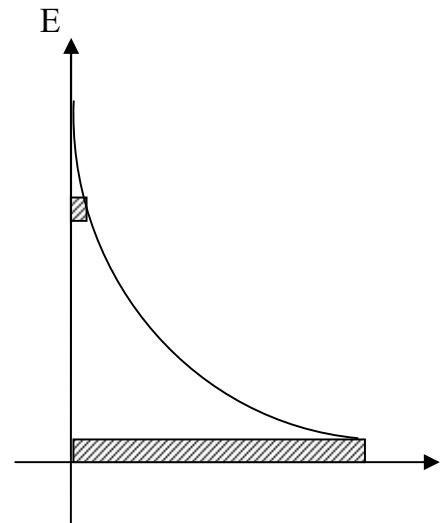

Fig 5) Exponential decrease of population

$$N_1 = N_0 e^{-E_1/KT} \text{ -----(3)}$$

$$\text{Now } \frac{N_2}{N_1} = \frac{e^{-E_2/KT}}{e^{-E_1/KT}}$$

$$\frac{N_2}{N_1} = e^{-(E_2-E_1)/KT}$$

$$N_2 = N_1 e^{-(E_2-E_1)/KT}$$

$$N_2 = N_1 e^{-E/KT} \text{ -----(4)}$$

Where $E = E_2 - E_1$

From the Boltzmann's law $N = N_0 e^{-E/KT}$ and equation (4) it is clear that $N_2 < N_1$ ($N_1 > N_2$) since $N_1 > N_2$, when ever an electromagnetic radiation incidents on the system, there is a **net absorption**.

For laser action to take place, it is important that stimulated emission predominate over spontaneous emission.

I.e. The system will act like an absorptive system rather than an emissive system.

For predominance of stimulated emission over spontaneous emission, we should have the condition $N_2 > N_1$.

That is the upper level should be more populated than the lower levels.

This situation where $N_2 > N_1$ is called population inversion.

This concept can be best illustrated by considering a three level energy system.

Consider a system with three energy levels E_1, E_2, E_3, \dots . When the system is in equilibrium the uppermost state E_3 is populated least and the lower state E_1 is populated most as shown in the figure (6).

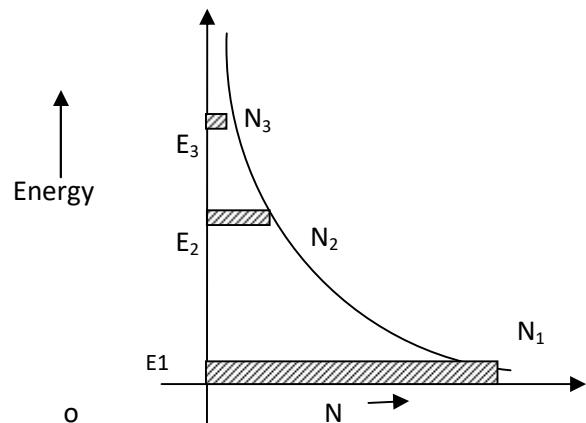

Fig. (6) Exponential decrease of population Unit-II Lasers and Fiber Optics

This is a Boltzmann distribution curve. Since the population in the various states is such that $N_3 < N_2 < N_1$ the system is absorptive rather than emissive.

But on excitation by outside energy, it is possible that N_2 exceeds N_1 .

This is possible if E_2 happens to be a **metastable** state. i.e. An energy state with a large time and the transition probability between levels 3 and 2 is very high.

The population inversion is achieved and is shown in figure (7).

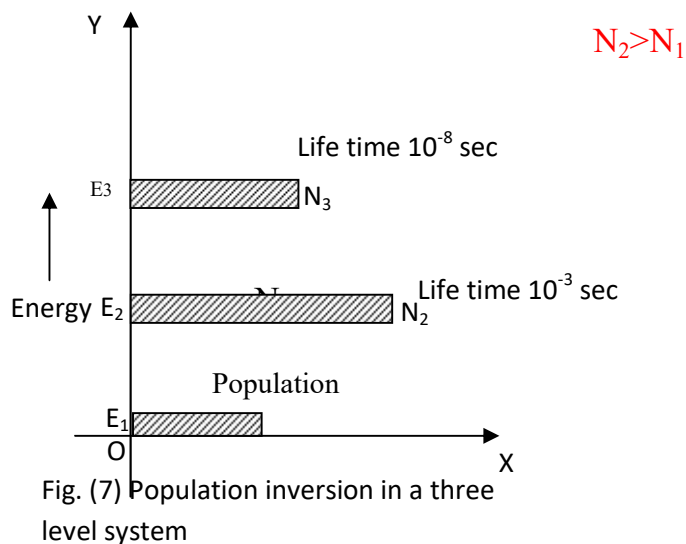

Usually E_3 is very close to E_2 . E_2 and E_1 are well separated.

The life times are shown in the diagram.

Conditions for population inversion

The important conditions for population inversion are

- 1) There must be at least a pair of energy levels in the system.
- 2) The energy must be supplied continuously to the system.

Usually population inversion is achieved by a process called pumping

Ruby laser

In the year 1960 Maiman constructed a laser using a Ruby crystal. Ruby is a synthetic material.

Ruby is a synthetic Aluminum oxide (Al_2O_3) with 0.05% weight of chromium oxide Cr_2O_3 added to it. The chromium ions (Cr^{+3}) are the active medium, the aluminum and oxygen atoms are interest.

Construction

Ruby consists of a matrix of Aluminum oxide in which some of aluminum ions are replaced by chromium ions.

Between the energy levels of chromium ions only losing action takes place.

The ruby crystal cut into a cylindrical rod. The length of ruby rod is around 2-20 cm and diameter around 0.1-2 cm.

The ruby crystal is Al_2O_3 which is doped with 0.05% weight of chromium oxide (Cr_2O_3).

The ends of the Ruby rod are made flat and parallel. On end of the ruby rod is fully silvered, the other end is made partially reflecting and partially transmitting.

i.e. one end will act like totally reflecting surface and the other end is 90% reflecting and 10% transmitting in order to obtain same output from the device.

The Ruby rod is enclosed in an envelope. The entire system is surrounded by a helical Xenon flash lamp. The helical Xenon flash lamp is supplied with a high voltage DC source.

The DC high voltage source is connected to a resistance R and a capacitor 'C' as shown in the figure (8).

Due to C-R element in the power circuit, a pulsating voltage will be supplied to the flash lamp. The two ends of the Ruby rod will act as an optical resonator.

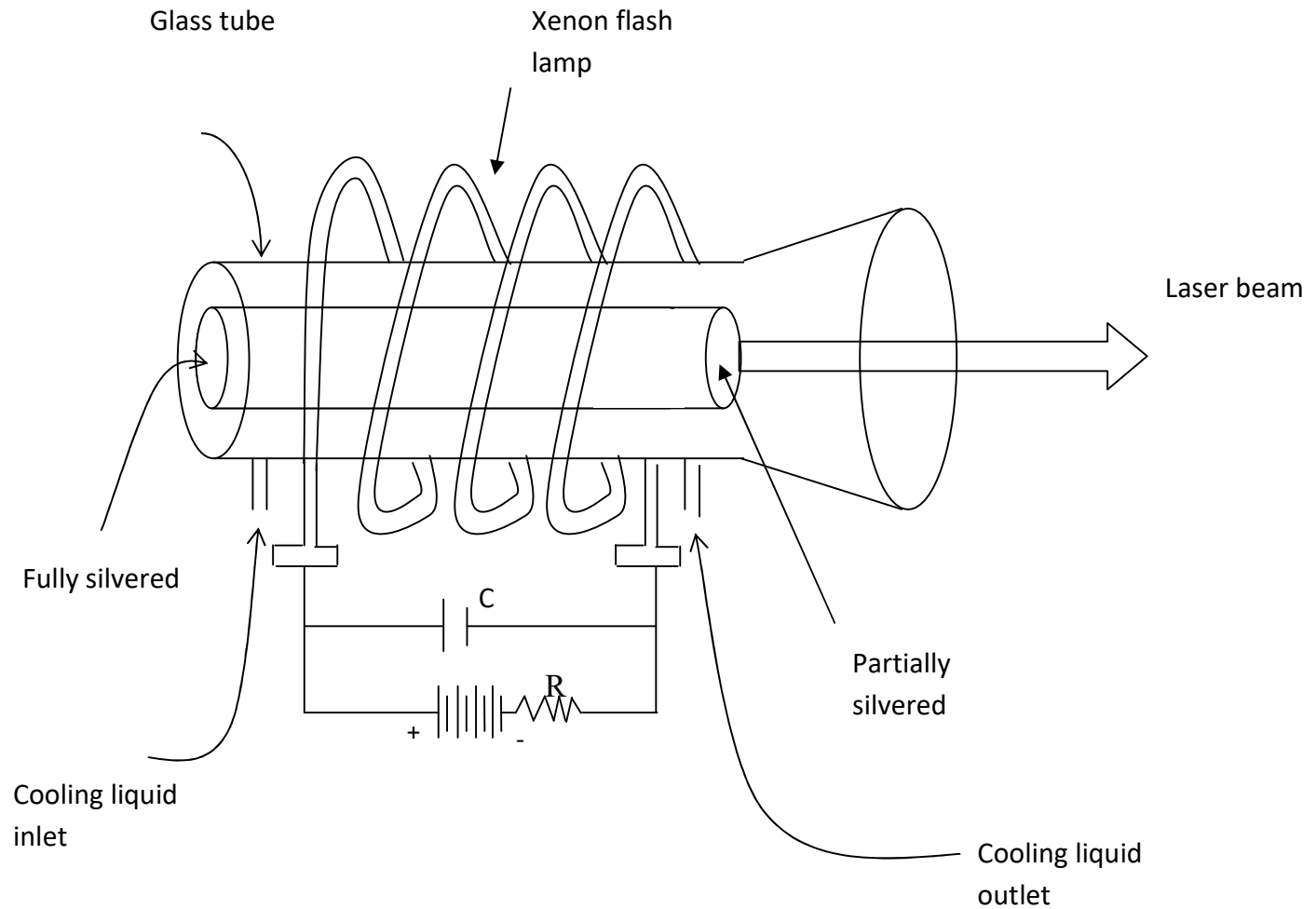

Figure (8) The Ruby laser

Working

When the power supply is switched on, due to C-R element, a pulsating voltage is applied to the xenon flash lamp.

Due to flashing a xenon flash lamp, an intense white light is produced.

The intense white light falls on the Ruby rod. The ruby rod absorbs light falling on it.

The chromium ions (Cr^{+3}) in the ground state absorbs radiation in the wave length regions of 4000\AA and 6600\AA .

Chromium ions are excited to the higher energy levels E_2 and E_3 as shown in the figure (9).

The energy levels E_2 and E_3 are containing bonds of energy levels.

Energy levels E_2 and E_3 accommodate all the chromium ions pumped from the ground level.

The chromium ions excited to the energy levels E_2 and E_3 decays rapidly through non radiative transition to a metal stable state in a time of 10^{-8} sec.

The metastable state M accumulated with chromium ions, since the life time is around 10^{-3} sec.

If energy is supplied continuously to the system, a stage is reached where the population inversion takes place between E_1 (ground state) and the metastable state M .

The transition of chromium ions from E_1 to E_2 results in the emission of photons. The stimulated emission of radiation dominates over spontaneous emission due to $N_{E_1} < N_M$ or $N_M > N_{E_1}$. This results in the emission of laser radiation of wavelength 6943\AA .

This output of laser is in the red region of the electromagnetic spectrum. Due to rapid non-radiative transition from E_2, E_3 to M , heat will be liberated.

This liberated heat will be absorbed by the surrounding Ruby lattice.

To avoid heating of the Ruby rod, the device is cooled in liquid nitrogen.

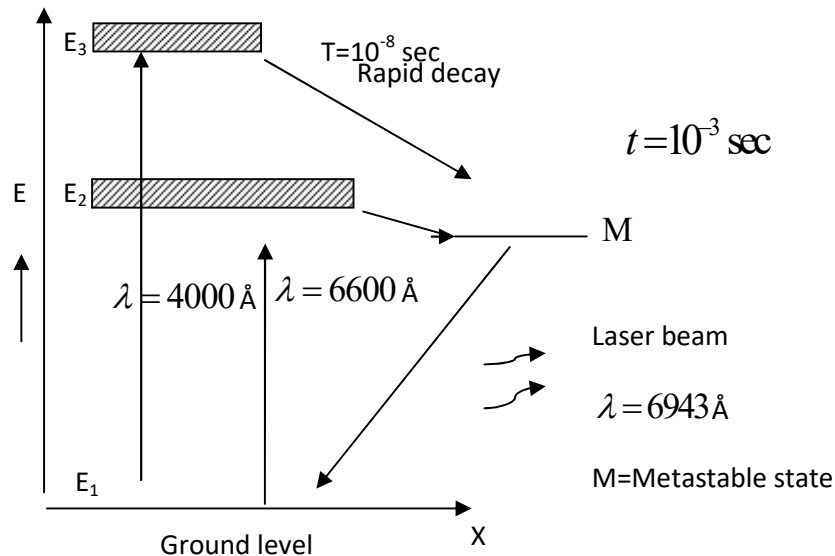

Figure (9) the energy level diagram of ruby laser with chromium ions.

Due to metastable characteristic of level M. population in M will be building up and inversion is achieved.

The output of the laser is pulsating since charging and discharging of capacitor takes place through the resistor.

Helium – Neon Gas laser

Helium – Neon Gas laser is a mixed gas laser. The first continuously operating laser was constructed in 1960 by Javan, Bennet and Herriot and the Bell telephone laboratories.

In this laser the actual laser action takes place between excited levels of Neon.

Helium Gas is present to excite the Neon Atoms to a higher level.

Construction of Helium – Neon Gas laser

The Helium – Neon gas laser consists of a quartz discharge tube of 100 cm length.

The internal diameter of the discharge tube is around 2-8 mm.

The discharge tube is filled with a mixture of Helium at 1 torr pressure and Neon at 0.1 torr pressure. Helium and Neon gases are mixed in the ratio 10:1. The length of the discharge in the tube is nearly about 80 cm.

The important components of the He-Ne gas laser are shown in the figure (10).

One end of the tube is arranged with 100% reflecting concave mirror and the other end is arranged with a partially reflecting and partially transmitting concave mirror.

From the second end, we get laser output.

The end windows are maintained at the Brewster angle and hence they are known as Brewster windows.

The discharge tube is having two electrodes. The electrodes are connected with a high voltage source of 1kv – 2 kv, through a resistor.

$$1 \text{ torr} = 1 \text{ mm of mercury}$$

$$1 \text{ torr} = 133.32 \text{ pascal}$$

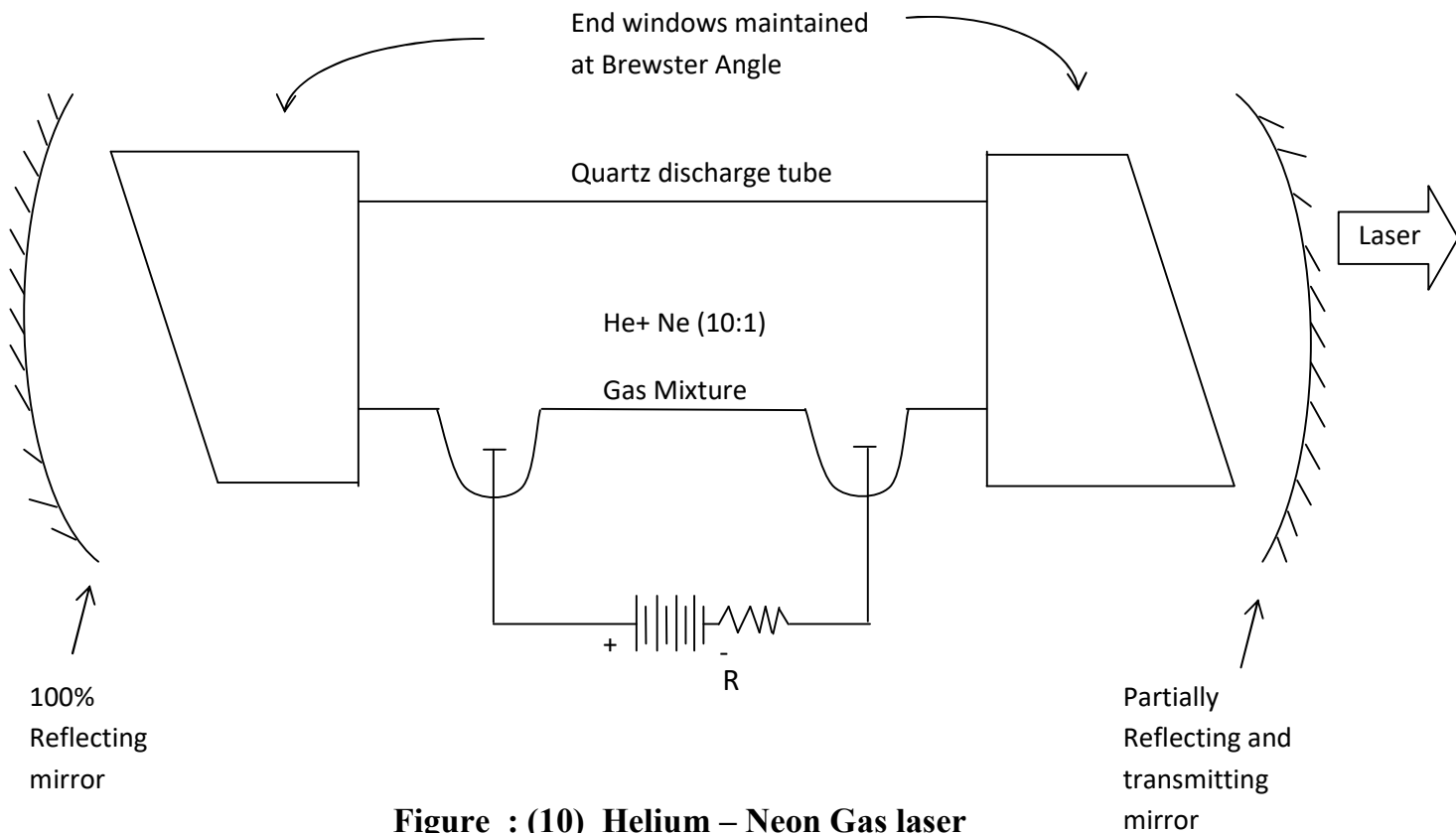

Figure : (10) Helium – Neon Gas laser

Working of the laser

When a high voltage dc source is switched on, an electrical discharge is passed through the gas.

During this discharge, electrons are accelerated down the discharge tube.

The electrons collide with Helium and Neon atoms. Helium and Neon atoms are in the ratio of 10:1.

Helium atoms are excited to higher energy levels. The energy level diagram of the laser is shown in figure (11).

This diagram shows the energy levels of Helium and Neon Atoms.

The Helium atoms tend to accumulate at energy levels F_2 and F_3 due to their long life times.

(10^{-4} and 5×10^{-6} secs).

Helium atoms collide with electrons and are excited to higher energy levels F_2 and F_3 .

Through atom – atom inelastic collisions He atoms collide with Ne atoms.

Hence energy is transferred between Helium and Neon atoms. Therefore Neon atoms are excited to higher energy levels.

The levels of Neon E_4 and E_6 have almost same energy as that of F_2 and F_3 .

Hence the excited Helium atoms colliding with Neon atoms in the ground state excite Neon atoms to E_4 and E_6 .

Since the pressure of Helium is ten times that of neon, the levels of E_4 and E_6 are selectively populated as compared to other levels of Neon. The collision reaction is shown below.

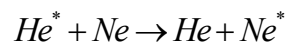
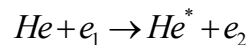

In the above equation e_1 and e_2 are electrons

He^* Excited Helium Atoms

Ne^* Excited Neon Atoms

Transitions between E_6 and E_3 produces the 6328\AA line of the He-Ne laser in the Red region.

Neon atoms deexcite through spontaneous emission from E_3 to E_2 .

The level E_2 is metastable and thus collects atoms. The atoms from this E_2 level fall back to ground level through collision with the walls of the tube. The other two important wavelengths from the He-Ne laser are

- i) 1.15 μm from which corresponds to $E_4 \rightarrow E_3$ transition.
- ii) 3.39 μm from which corresponds to $E_6 \rightarrow E_5$ transition.

Here a perfect population inversion is achieved between the energy levels

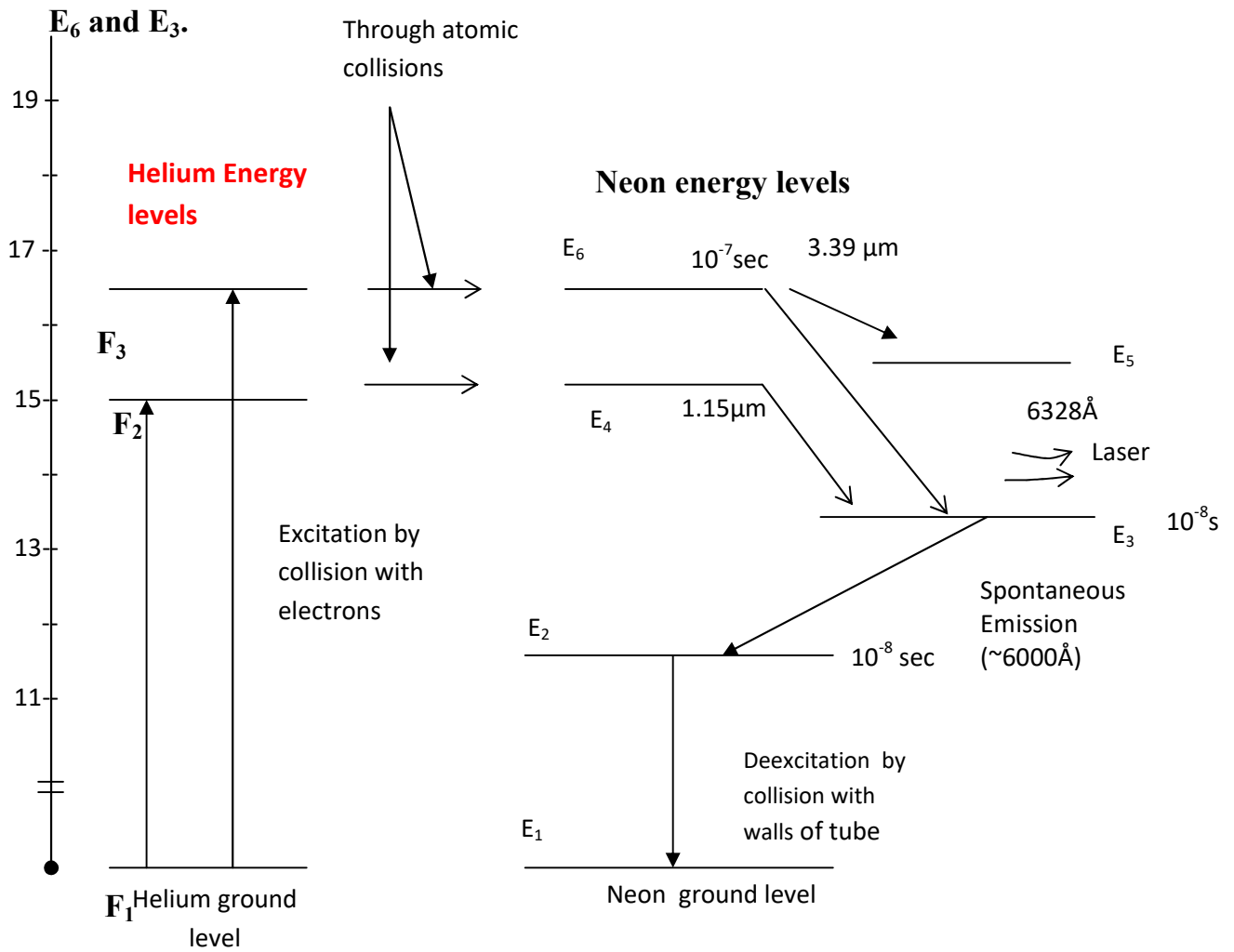

Figure (11) Energy level diagram of Helium – Neon laser

The emitted laser wave consists of two components called perpendicular polarized wave and parallel polarized wave.

To avoid the perpendicular polarized component, the end windows are maintained at Brewster Angle.

The Brewster angle θ_B is given by

$$\theta_B = \tan^{-1} \sqrt{\frac{n_2}{n_1}}$$

Where n_1 = Refractive index of the gas mixture.

n_2 = Refractive index of glass

The perpendicular polarized wave is completely attenuated by the windows plate.

The parallel polarized wave is transmitted by the window is in the same direction.

The parallel polarized wave is repeatedly reflected by the resonator mirrors situated behind the Brewster windows. Here correspondingly the light passes repeatedly through the active medium.

Advantages

1. The laser light emitted by the Gas lasers is highly monochromatic and directional when compared to solid state lasers.
2. He-Ne laser emits continuous wave of laser light.
3. Due to the presence of Brewster windows at the ends, the output laser light is linearly polarized.
4. In put power is 5-10 watts.
5. Output power is 1-100 mw.

Semi conductor PN junction laser

GaAs and GaAsP lasers were the first PN junction semi conductor lasers built in 1962.

When a PN junction is forward biased at emits coherent radiation.

Principle

When a PN junction is formed between P and N materials of a semiconductor, depletion layer is formed across the junction.

When the junction is forward biased, the width of depletion layer decreases. Due to this electrons will flow from N side the P side of the junction. Here electron – hole recombination takes place.

Due to this recombination of electrons with holes, light is emitted out from the junction.

The PN junction which is forward biased and the energy bond diagram showing in the figure (1)a and (1) b.

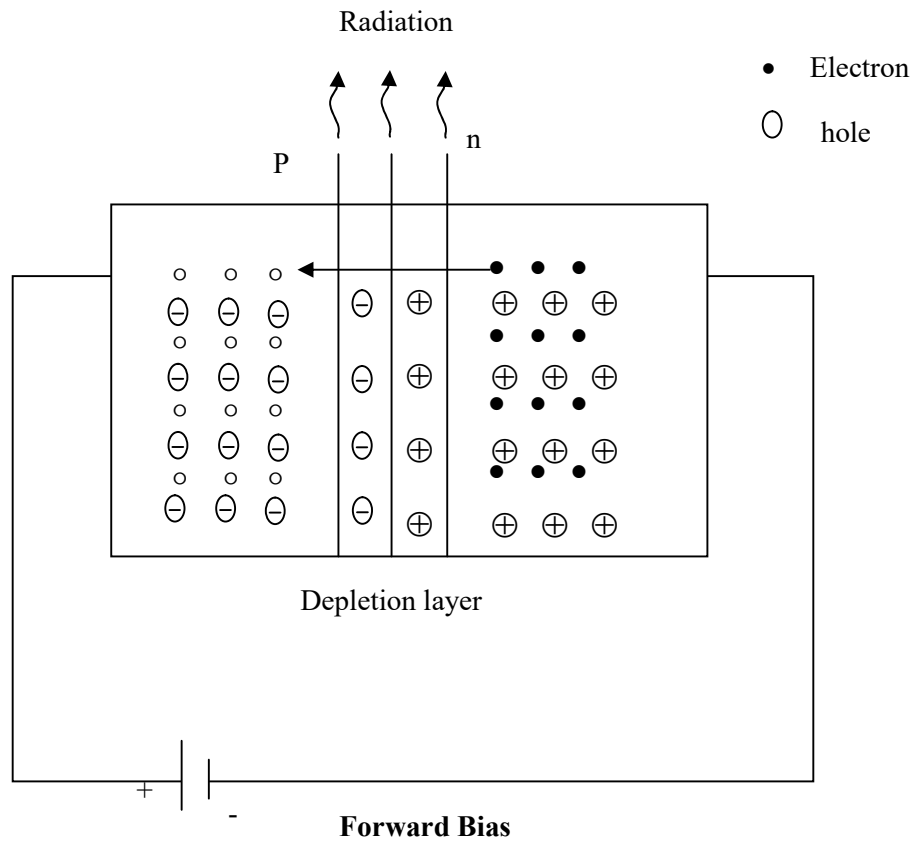

Fig. 1)a Forward biased Pn junction

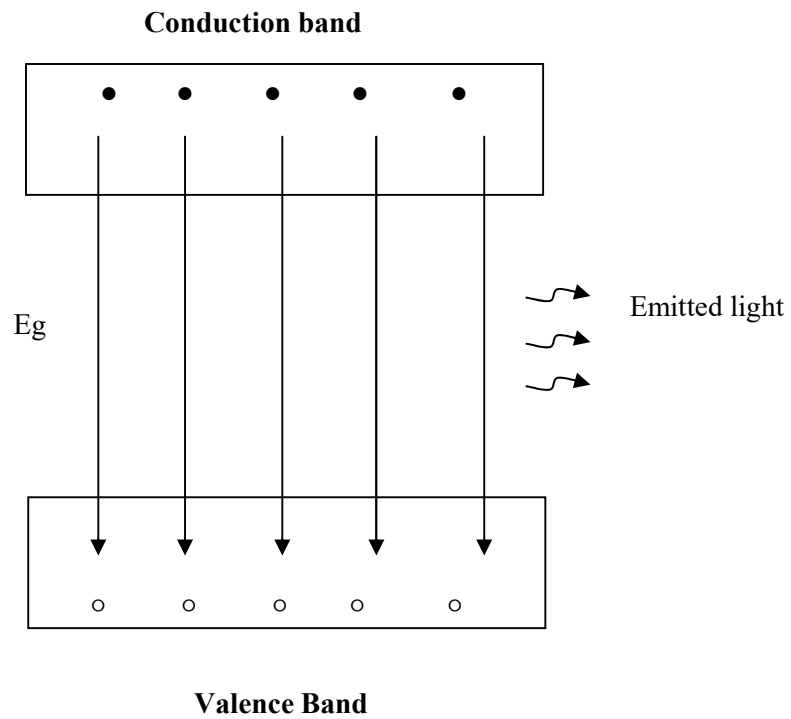

Fig. 1)b Energy band diagram

The energy band diagram, showing the movement of carriers, is shown in the figure (2)

Conduction band

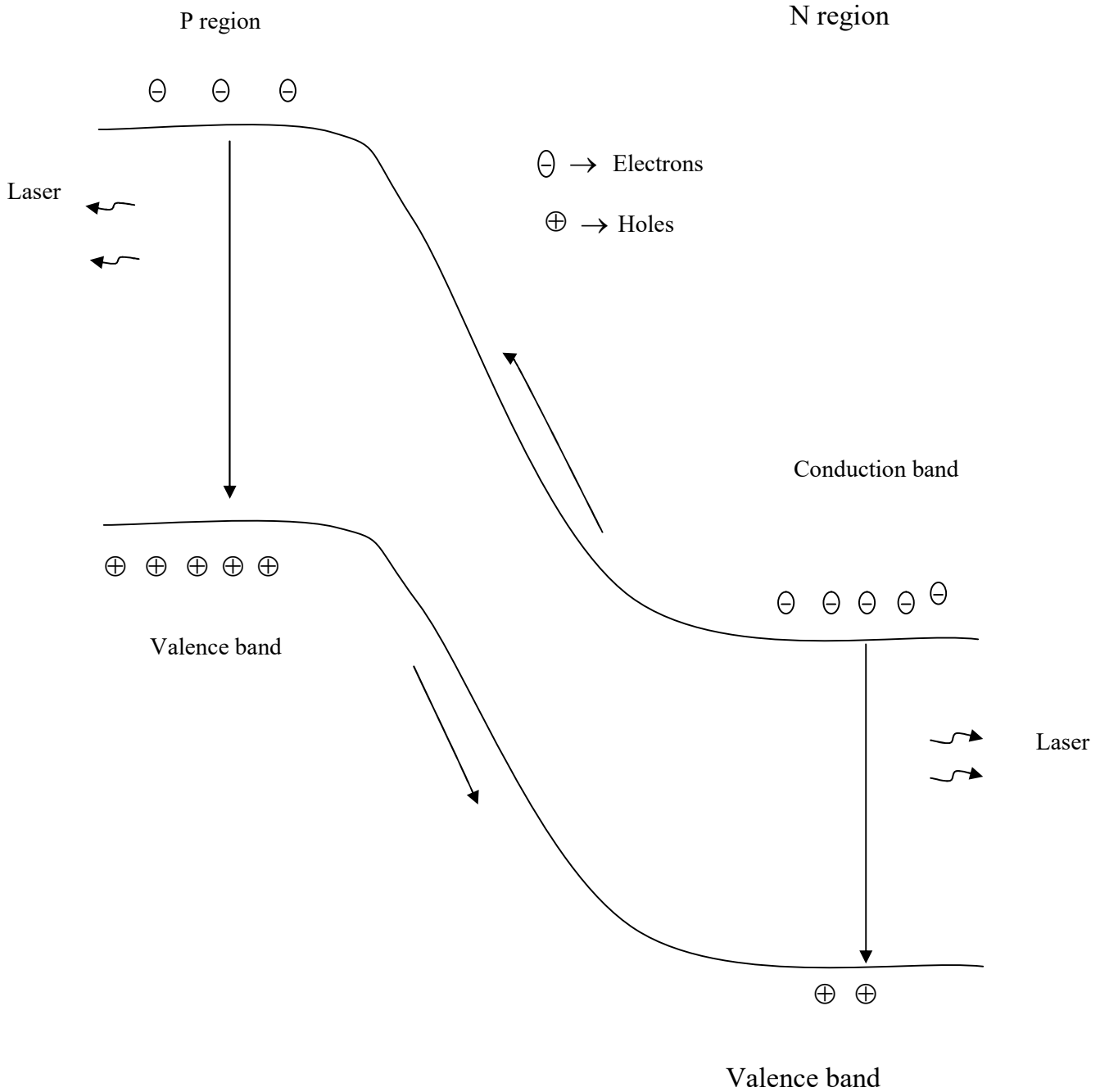

Figure (2) Energy level diagram of P_n junction laser device.

The valence bond in P-region has holes \oplus and the conduction bond in N-Region has free electrons -. When the junction is forward biased, current flows. The electrons from the conduction bond of N-region make a transition to the valence Band of P-Region. During this transition, electrons recombine with holes, emitting radiation corresponding to the energy gap.

This process is called Radiative combination. During this process radiation is emitted out.

When current is increased beyond threshold current, stimulated emission occurs. This ensures a laser light beam.

The energy of the emitted radiation is given by

$$E = h\nu = Eg$$

The frequency of the emitted laser light is given by

$$\nu = \frac{Eg}{h}$$

We know that $c = \nu\lambda$

$$\nu = \frac{C}{\lambda}$$

$$\therefore \frac{C}{\lambda} = \frac{Eg}{h}$$

The wavelength of emitted laser light is given by

$$\lambda = \frac{hc}{Eg}$$

Where h= planck's constant

C= Velocity of light

Eg= Energy band gap of the semi conductor.

From Equation (1), it is clear that, the wave length of the emitted laser light depends on the energy gap of the semi conductor.

Usually, GaAs semi conductors is used as a direct Band gap semi conductors.

Construction

The Basic structure of a PN-junction semiconductors laser is shown in figure (3). A GaAs semi conductors is taken and is doped with impurities such that a p and n regions are formed in the GaAs. Semi conductor.

A pair of parallel planes is cleaved or polished perpendicular to the plane of the junction. The two remaining sides of the diode (front and rear face) are roughened to eliminate lasing. The lasing action takes place in one direction only i.e. perpendicular to the plane of polished surface.

Fig(3): Basic structure of PN junction semiconductor Laser

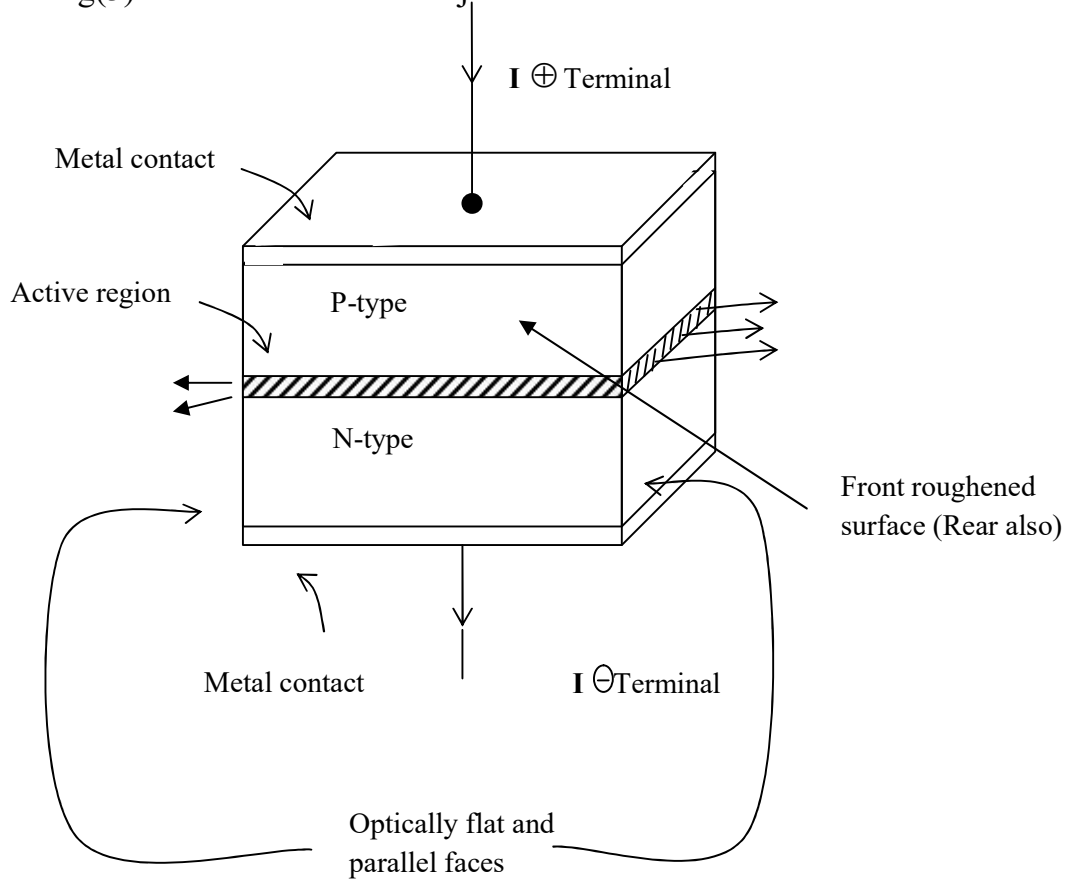

This structure is called a Fabry- perot cavity. The others two sides are used for Metal contacts. One metal contact serves the purpose of heat sink. Here the junction is formed between P and n materials in the same host lattice. In the semi conductors laser doping concentration levels are high.

Two flat polished parallel planes will serve the purpose of optical resonator.

Working

When P-type is connected to the positive terminal of a Battery and N-type is connected to the negative terminal then the pn junction will be in forward bias condition.

Due to forward Bias, a current flows in the diode.

Initially at low current there is spontaneous emission in all directions.

When the forward bias increases, eventually a threshold current is reached at which the stimulated emission occurs. A highly monochromatic radiation is emitted from the junction. Here electron – hole recombination takes place across the junction.

The source of excitation is in the Battery (Forward Bias). The actual pumping process is direct conversion.

The output of the semi conductor laser is in the infra red region wavelength range of 9000Å.

Advantages

1. The efficiency of the laser is high.
2. Laser output can be modulated by modulating the junction current.
3. The laser's output is tunable to a continuous wave or pulsed wave.

Einstein's coefficients

Consider a two level energy system as shown in the figure (1).

Let E_1 be the energy of the lower level.

Let N_1 be the population in the lower energy level E_1 .

Let E_2 be the energy of the upper level.

Let N_2 be the population of the upper level E_2 .

Here $E_2 > E_1$.

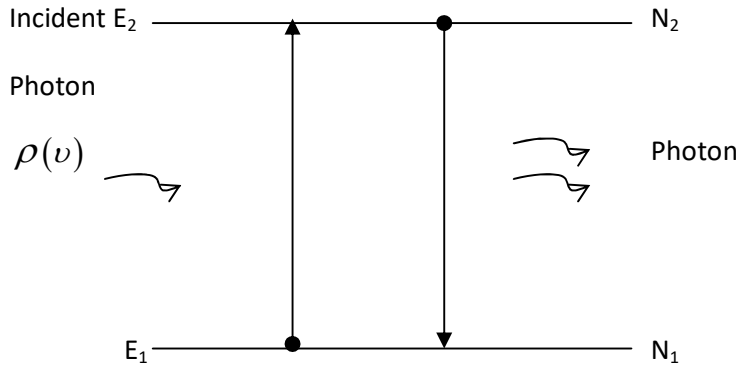

Figure (1) Absorption and emission in a two level system

Now let a photon of density $\rho(\nu)$ incidents on the system.

In the presence of incident radiation, the atoms in E_1 , will absorb energy.

Due to this the atoms get excited to higher energy level E_2 . This is called stimulated absorption.

The number of stimulated absorptions $\propto N_1$

$$\propto \rho(\nu)$$

The number of stimulated absorptions $\propto N_1 \rho(\nu)$

The number of stimulated absorptions = $B_{12} N_1 \rho(\nu)$ ----- (1)

B_{12} is called Einstein 'B' coefficient for stimulated absorption of Radiation.

The excited Atoms in the energy level E_2 makes transitions to the lower energy level by two ways.

(i) By Spontaneous Emission

ii) by absorbing the incident radiation of density. $\rho(\nu)$ the atoms in the upper energy level E_2 makes a transition to lower energy level by way of stimulated emission of radiation.

Now the number of spontaneous emissions of Radiation $\propto N_2$.

$$\text{Number of spontaneous emissions of Radiation} = A_{21}N_2 \quad \text{-----}(2)$$

Here A_{21} is a constant of proportionality. A_{21} is called Einstein 'A' coefficient for spontaneous emission of Radiation.

Also the number of stimulated emissions of radiation $\propto N_2$

$$\alpha\rho(\nu)$$

\therefore The number of stimulated emission of Radiation $\alpha\rho(\nu)N_2$

$$\text{The number of stimulated emission of Radiation} = B_{21}\rho(\nu)N_2 \quad \text{-----}(3)$$

Where B_{21} is called Einstein 'B' coefficient for stimulated emission of Radiation.

Now the amount of incident radiation energy is absorbed and is utilized in two ways. i.e. the Absorbed energy is utilized for spontaneous emission and stimulated emission.

$$\therefore \text{Stimulated Absorption} = \text{Spontaneous emission} + \text{Stimulated emission}$$

i.e. No. of stimulated Absorption of radiation = No. of stimulated emission of radiation. + No. of Spontaneous emission of radiation.

$$\therefore B_{12}N_1\rho(\nu) = A_{21}N_2 + B_{21}N_2\rho(\nu)$$

$$B_{12}N_1\rho(\nu) - B_{21}N_2\rho(\nu) = A_{21}N_2$$

$$\rho(\nu)[B_{12}N_1 - B_{21}N_2] = A_{21}N_2$$

$$\therefore \rho(\nu) = \frac{A_{21}N_2}{(B_{12}N_1 - B_{21}N_2)} \quad \text{-----} (4)$$

Divide both numerator and denominator with N_2

$$\rho(\nu) = \frac{A_{21}}{\left(B_{12} \frac{N_1}{N_2} - B_{21} \right)}$$

$$\text{Also } \rho(\nu) = \frac{A_{21}}{B_{21} \left(\frac{B_{12}}{B_{21}} \frac{N_1}{N_2} - 1 \right)} \quad \text{----- (5)}$$

Now from Boltzmann distribution law

$$N_1 = N_0 e^{-E_1/KT} \quad \text{----- (6)}$$

$$N_2 = N_0 e^{-E_2/KT} \quad \text{----- (7)}$$

Where N_0 = population in the ground level.

N_1 = population in the lower level E_1 .

N_2 = population in the upper level E_2 .

K = Boltzmann constant

T = Temperature in $^{\circ}\text{K}$

E_1 = Energy of the lower level.

E_2 = Energy of the upper level.

$$\text{Now } \frac{N_2}{N_1} = \frac{N_0 e^{-E_2/KT}}{N_0 e^{-E_1/KT}}$$

$$\frac{N_2}{N_1} = \frac{e^{-E_2/KT}}{e^{-E_1/KT}}$$

$$\frac{N_2}{N_1} = e^{-E_2/KT} e^{E_1/KT}$$

$$\frac{N_2}{N_1} = e^{\frac{-E_2 + E_1}{KT}}$$

$$\therefore \frac{N_2}{N_1} = e^{-(E_2 - E_1)/KT}$$

$$\Rightarrow \frac{N_2}{N_1} = e^{-E/KT} \quad \text{----- (8)}$$

Where $E = E_2 - E_1$

$$\text{Also (8)} \Rightarrow \frac{N_1}{N_2} = e^{E/KT} \quad \text{----- (9)}$$

Now from equations (5) and (9), we get

$$\rho(\nu) = \frac{A_{21}}{B_{21} \left[\frac{B_{12}}{B_{21}} (e^{E/KT}) - 1 \right]}$$

But we know that $E = h\nu$

$$\therefore \rho(\nu) = \frac{A_{21}}{B_{21} \left[\frac{B_{12}}{B_{21}} \left(e^{\frac{h\nu}{KT}} \right) - 1 \right]} \quad \text{----- (10)}$$

Now according to Planck's Black body radiation formula, the radiation density is given by

$$\rho(\nu) = \frac{8\pi h\nu^3}{C^3} \frac{1}{\left(e^{\frac{h\nu}{kT}} - 1 \right)} \quad \text{----- (11)}$$

Now comparing equations (10) and (11), we get

$$\frac{A_{21}}{B_{21}} = \frac{8\pi h\nu^3}{C^3} \quad \text{----- (12)}$$

$$\text{Also } \frac{1}{\left(e^{\frac{h\nu}{kT}} - 1 \right)} = \frac{1}{\left[\frac{B_{12}}{B_{21}} \left(e^{\frac{h\nu}{kT}} \right) - 1 \right]}$$

Comparing the LHS and RHS in the above,

$$\Rightarrow \frac{B_{12}}{B_{21}} = 1 \Rightarrow B_{12} = B_{21} \quad \text{----- (13)}$$

I.e. Rate of stimulated Absorption of radiation = Rate of stimulated Emission of radiation.

Applications of Lasers

Industry

1. Two dissimilar metals can be weld using a laser.
2. Laser is used to cut glass and quartz.
3. Lasers are used to drill holes in Quartz and ceramics.
4. Lasers are used for heat treatment in the tooling and automotive industry.

Medicine

1. To attach a detached retina, it is used in ophthalmology.
2. Lasers are used in correcting short sight.
3. Used for cataract removal.
4. Lasers are used in bloodless surgery.
5. Lasers are used in cosmetic surgery called mammoplasty.(plastic surgery)
6. Lasers are used in Angioplasty for the Removal of artery Block.
7. Used in the diagnosis of cancer therapy.
8. For removing stones in Kidneys and Gall Bladder.

Science

1. Lasers are used in Isotope separation.
2. Recording and Reconstruction of Holograms.
3. Used to create plasma.
4. Used to produce chemical reactions.
5. To study internal structure of micro organisms and cells.
6. To study the structure of molecules.

LASER COMPONENTS

ACTIVE MEDIUM

Solid (Crystal)
Gas
Semiconductor (Diode)
Liquid (Dye)

EXCITATION MECHANISM

Optical
Electrical
Chemical

OPTICAL RESONATOR

HR Mirror and
Output Coupler

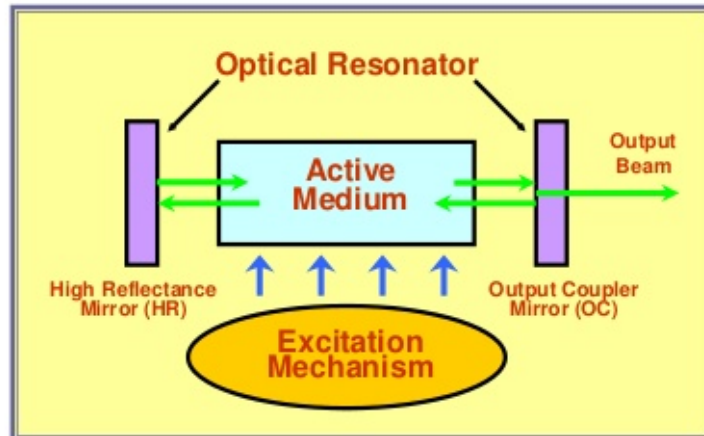

The **Active Medium** contains atoms which can emit light by stimulated emission.

The **Excitation Mechanism** is a source of energy to excite the atoms to the proper energy state.

The **Optical Resonator** reflects the laser beam through the active medium for amplification.

Neodymium-YAG Laser

Nd ion is rare earth metal and it is doped with solid state host crystal like yttrium aluminium garnet (YAG – $Y_3Al_5O_{12}$) to form Nd:YAG laser. Due to doping, yttrium ions get replaced by the Nd^{3+} ions. Also, the doping concentration is around **0.725%** by weight.

Its working principle is such that when optical pumping is provided to the device then the Nd ions get raised to higher energy levels and their transition produces a laser beam.

This laser generally emits light of wavelength of nearly **1.064 μm** .

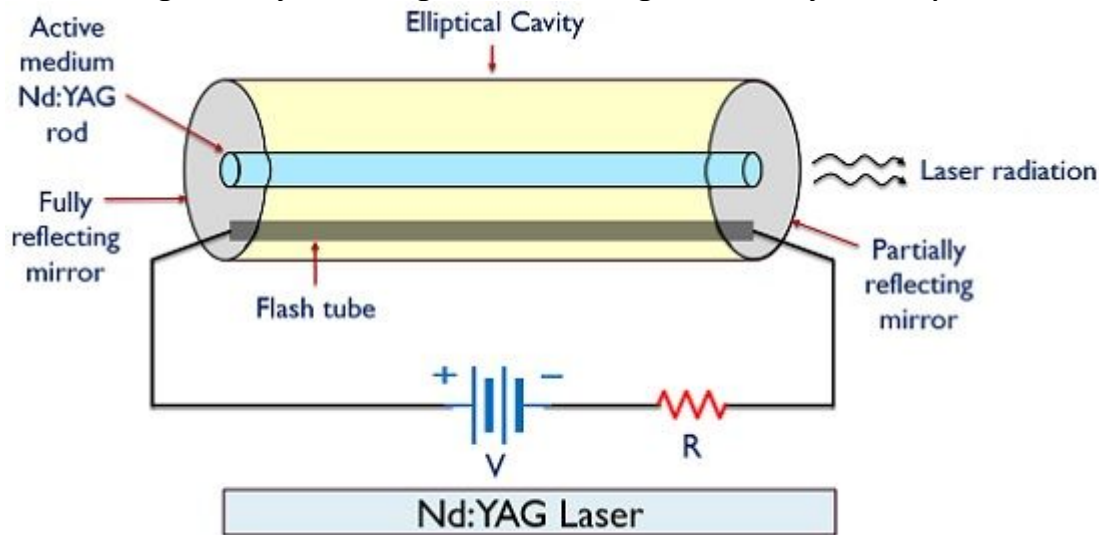

Circuit Globe

Active medium: This is also known as the laser medium and is the middle portion of the structure i.e., Nd:YAG crystal. Basically when the external energy source is provided then the electrons from lower energy state moves to higher energy state thereby causing lasing action to take place.

External Energy source: Due to the difference in the energy levels, the electrons need some external pumping in order to perform a transition from one state to another. So, for lasing action to take place an external pump source is required.

Basically, as a source of optical pumping, xenon or krypton flash tube is taken in its case.

The Nd:YAG rod and the flash tube are placed inside an elliptical cavity so, that maximum produced light can reach the rod.

Optical resonator: The two ends of the Nd:YAG rod is coated with silver. However, one end is completely coated with silver so as to achieve maximum light reflection.

While the other end is partially coated in order to provide a path for the light ray from an external source to reach the active medium. There by forming an optical cavity.

Working of Nd:YAG laser

It is a 4 level system i.e.; it contains 4 energy levels. So, in this section, we will discuss the working of Nd:YAG laser with the help of the energy level diagram.

The figure below shows the 4 state energy level diagram of Nd:YAG laser: These energy levels are those of Neodymium (Nd^{3+}) ions.

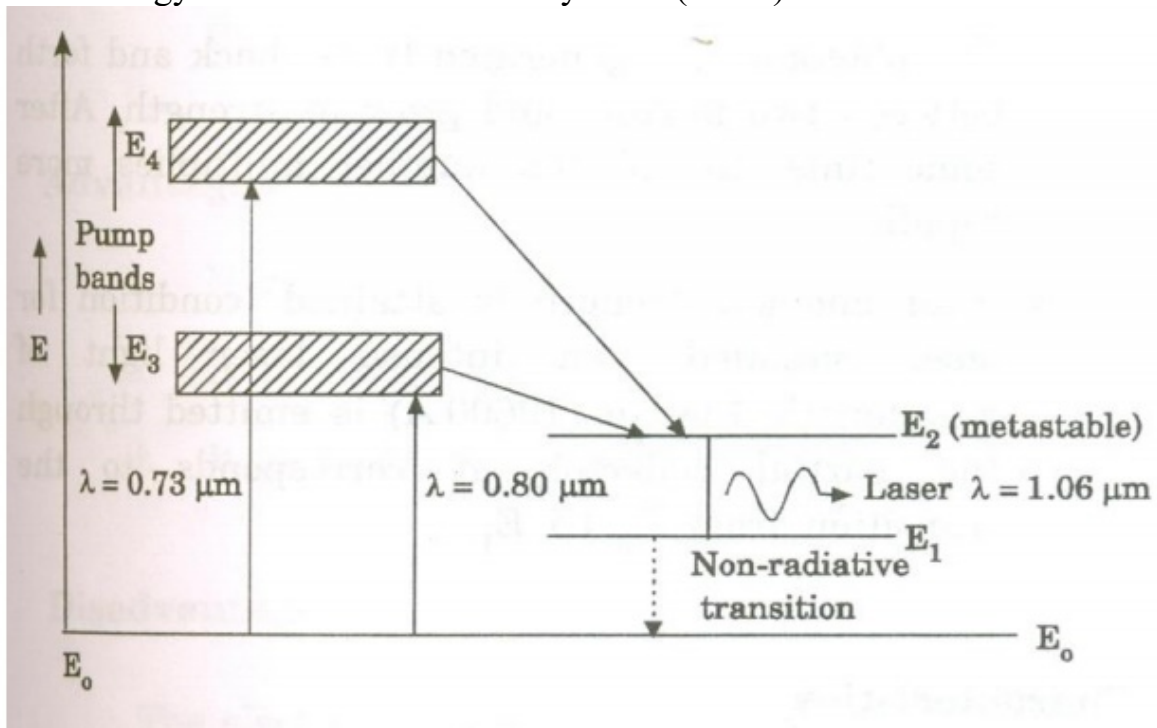

1. When the krypton flash lamp is switched on, by the absorption of light radiation of wavelength $0.73\mu\text{m}$ and $0.8\mu\text{m}$, the Neodymium(Nd^{3+}) atoms raised from ground level E_0 to upper levels E_3 and E_4 (Pump bands).
2. Nd atoms make a transition from these energy levels E_2 by non-radiative transition. E_2 is a metastable state. Life time is 10^{-3}sec .
3. The Neodymium ions are collected in the level E_2 and the population inversion is achieved between E_2 and E_1 .
4. An Nd ion makes a spontaneous transition from E_2 to E_1 , emitting a photon of energy $h\nu$. This emitted photon will trigger a chain of stimulated photons between E_2 and E_1 .

5. The photons thus generated travel back and forth between two mirrors and grow in strength. After some time, the photon number multiplies more rapidly.

6. After enough strength is attained (condition for laser being satisfied),

an intense laser light of wavelength $1.06\mu\text{m}$ is emitted through the partial reflector. It corresponds to the transition from E₂ to E₁.

Characteristics:

1. **Type:** It is a four level solid state laser.
2. **Active medium:** The active medium is Nd: YAG Crystal.
3. **Pumping method:** Optical pumping is employed for pumping action.
4. **Pumping source:** Xenon or Krypton flash tube is used as pumping source.
5. **Optical resonator:** Two ends of Nd: YAG rod is polished with silver (one end is fully silvered and the other is partially silvered) are used as optical resonator.
6. **Power output:** The power output is approximately 70 watt.
7. **Nature of output:** The nature of output is pulsed or continuous beam of light.
8. **Wavelength of the output:** The wavelength of the output beam is $1.06\mu\text{m}$ (infrared)
9. For continuous operation of the device it must be cooled in liquid Neon or liquid Helium.

Advantages:

1. It has high energy output.
2. It has very high repetition rate operation
3. It is much easier to achieve population inversion.

Disadvantages:

The electron energy level structure of Nd³⁺ in YAG is complicated.

Applications:

1. It finds many applications in range finders and illuminators.
2. It is widely used in engineering applications such as resistor, trimming, scribing, micro machining operations as well as welding, drilling etc.
3. It finds many medical applications such as endoscopy, urology, neurosurgery, ENT, gynaecology, dermatology, dental surgery and general surgery.

Here a perfect population inversion is achieved between the energy levels E_6 and E_3 .

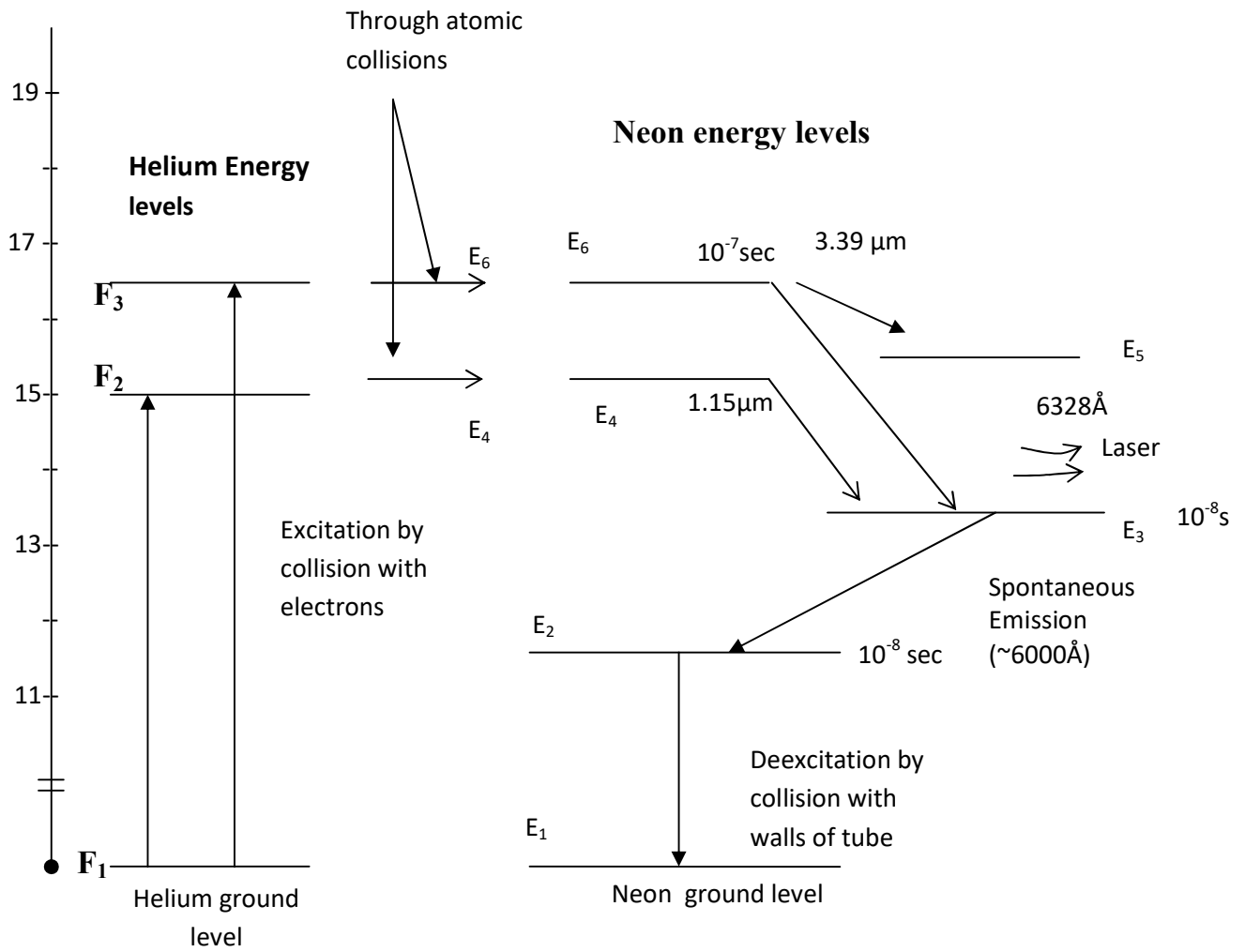
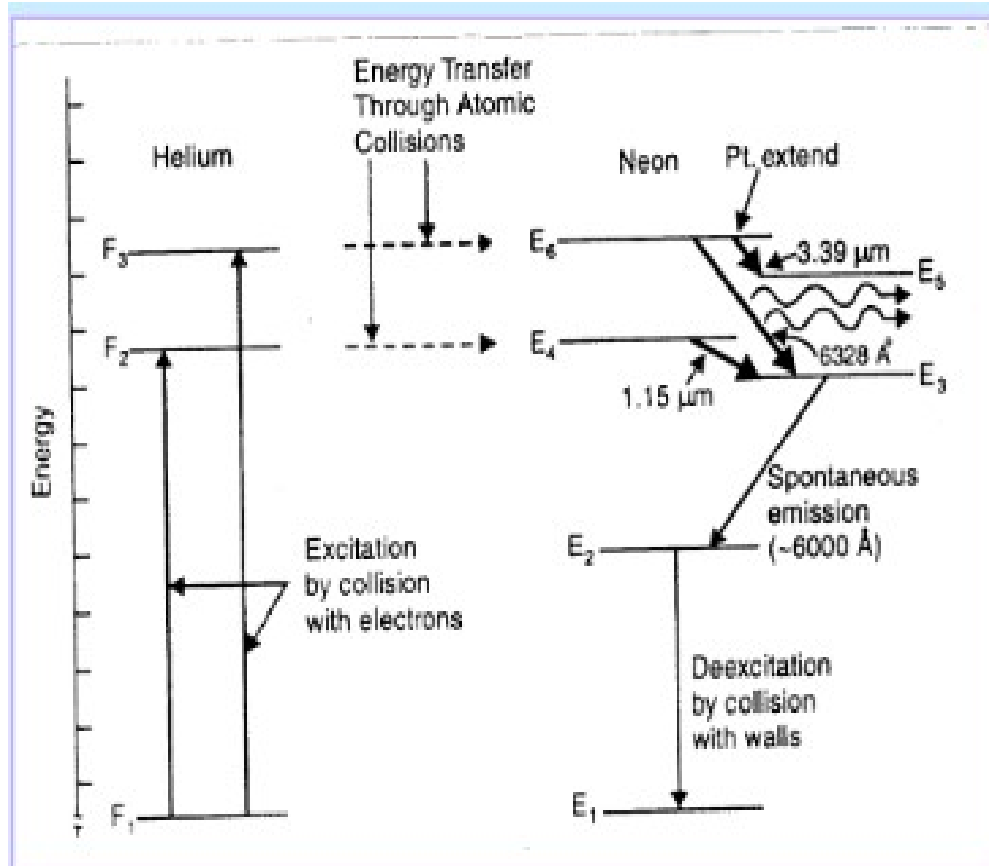

Figure (2) Energy level diagram of Helium – Neon laser



Energy levels of He and Ne atoms and transitions between the levels.

FIBER OPTICS

Introduction

Fibre is a material that can be drawn into a number of threads.

The thin like fibres are bundled and used as carriers of light energy.

Optical fibre is a thin transparent medium which carries information in the form of light.

The propagation of light through the optical fibre will be in the form of multiple total internal reflections.

The fibre basically consists of two regions namely core and cladding.

The core region of the fibre having higher refractive index carries most of the light. The core is surrounded by a cladding of lower refractive index.

These fibers improved the efficiency of transmission, reduced cross talk between fibers.

The optical signals will have frequency of light; therefore fibres can be used as carriers of information.

Advantages of optical fibres in communication

1. Fibres are having higher information carrying capacity i.e. band width is high.

This means that a greater volume of information or messages can be carried over in a fibre optic system.

This is because the rate at which information can be transmitted is directly related to signal frequency. Light has a frequency in the range of 10^{14} - 10^{15} Hz, compared to radio frequency of 10^6 Hz and microwave frequencies 10^8 - 10^{10} Hz.

Therefore a transmission system that operates at the frequency of light can theoretically transmit information at higher rate than systems that operate at radio frequencies or micro wave frequencies.

2. They are small in size and are very light in weight.
3. No possibility of internal noise and cross talk generation along with immunity to ambient electrical noise or electromagnetic induction.
4. No short circuit hazards as in the case of material wires.
5. In explosive environments, it can be used safely.
6. Immunity to adverse moisture and temperature conditions.
7. The cost of fibre optic cable is low when compared to copper / G.I. cables.
8. No need of additional equipment to protect against grounding and voltage problems.
9. The installation cost is nominal.
10. Fewer problems in space applications such as space radiation shielding and line to line data isolations.

Principle of optical fibre – total internal reflection

When ever a ray of light travelling from a medium of high refractive index to a medium of low refractive index, the light ray bends away from the normal.

When a ray of light is travelling from a denser medium to rarer medium, making an angle of incidence i , it will be refracted into the air medium, with angle of refraction r . This is shown in the figure (1) a. If the angle of incidence further increases, the angle of refraction also increases. This is shown in figure (1) b. At the interface, when the ray of light incidents at an angle called critical angle, the ray will not be refracted, but it will graze the interface. This is shown in fig (1) C.

When $i > \theta_c$, the ray will be totally reflected back internally into the same medium. This is shown in figure (1) d.

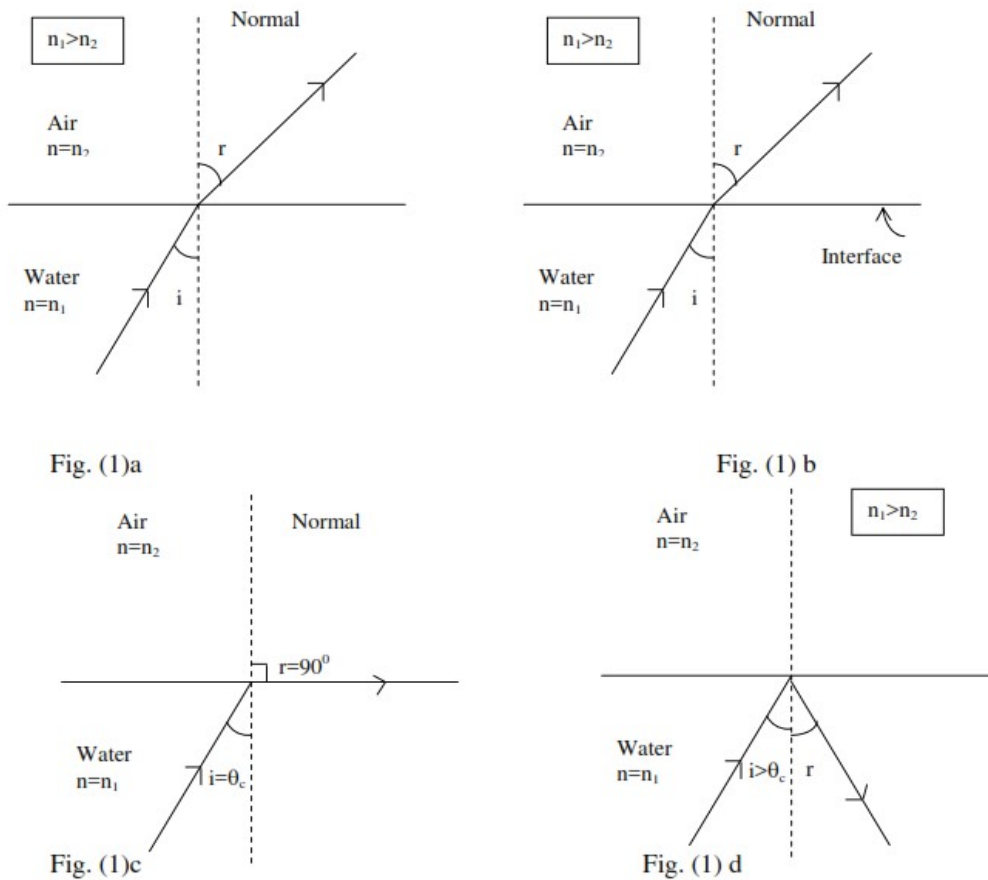

Figure (1) Light ray suffering total internal reflection.

Applying Snell's law for the ray of light suffering total internal reflection,

$$n_1 \sin i = n_2 \sin r \Rightarrow \sin i = \frac{n_2}{n_1} \sin r \quad \text{----- (1)}$$

In the case of a fibre, the ray of light travelling from a denser medium to rarer medium, will be totally internally reflected back into the same medium (i.e. into core).

Now consider the incident ray for which $r=90^0$ (i.e. $i=\theta_c$) then $\sin \theta_c = \frac{n_2}{n_1} \sin 90^0$

$$\therefore \sin \theta_c = \frac{n_2}{n_1} (n_1 > n_2) \quad \text{-----(2)}$$

Therefore for any ray of light whose angle of incidence is greater than this critical angle, total internal reflection takes place.

Fiber construction

An optical fiber consists of a thin central thread of transparent plastic or glass, which is surrounded by a second dielectric. The thin thread of central cylindrical material is called the core. The core is surrounded by another material called cladding. The refractive index of the core is slightly greater than that of cladding material such that the guidance of the light is only through the fiber of the core material. The refractive index of the core and cladding materials decides the properties of communication fibers. The size of the core and cladding also determines the characteristics of a fiber to some extent. The buffer Jacket (protective jacket) over the optical fiber is made of plastic and protects the fiber from moisture and abrasion. In between the buffer jacket and optical fiber, there is silicon coating. Due to this further isolation is achieved. Surrounding the buffer jacket there is a layer of strength member (Kevlar) which provides toughness and tensile strength. Here the fibre optic cable withstands without any brittleness during hard pulling, bending, stretching or rolling, though the fiber is made from brittle glass. Finally the cable is covered by black polyurethane outer Jacket. ($n_1 > n_2$).

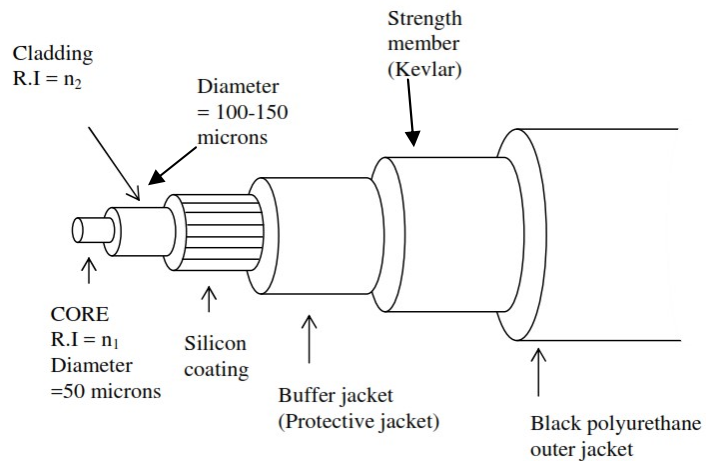

Figure (2) Fiber construction.

The fiber structure is shown in figure (2) for a typical fiber. Usually fibers are made with either plastic or glass. Thus there are two types of fibers. 1. Glass fiber 2. Plastic fiber

Glass fiber

Glass fibers are made by fusing mixtures of metal oxides and silica glass.

The most common material used in glass fibre is silica (oxide glasses). It has a refractive index of 1.458 at 850 nm. For producing two same materials having slightly different refractive indices for the core and cladding, either fluorine or various oxides such as B_2O_3 , Ge_2O_2 or P_2O_5 are added to silica.

Examples of Glass fibre compositions

1. $GeO_2 - SiO_2$ Core; SiO_2 Cladding
2. $P_2O_5 - SiO_2$ Core; SiO_2 Cladding
3. SiO_2 Core; $P_2O_5 - SiO_2$ Cladding

Another type of silica glasses are made with low melting silicates. Such optical fibres are made of soda-silicates, germane silicates and borosilicate.

Plastic fiber : The plastic fibers are typically made of plastics, are cheap and can be handled without special care due to their toughness and durability.

Examples of plastic fibers.

1. A Polystyrene core ($n_1=1.60$) and methyl methacrylate cladding ($n_2=1.49$).
A Polymethylmethacrylate core ($n_1=1.49$) and a cladding made of its co-polymer ($n_2=1.40$).

Propagation of light in fibers

Consider the light propagating in an optical fiber. Let us consider a ray of light which is incident on the entrance aperture of the fiber making an angle of incidence i with the axis, as shown in figure (3). PQ is the incident ray, making angle of incidence i . QR is the refracted ray.

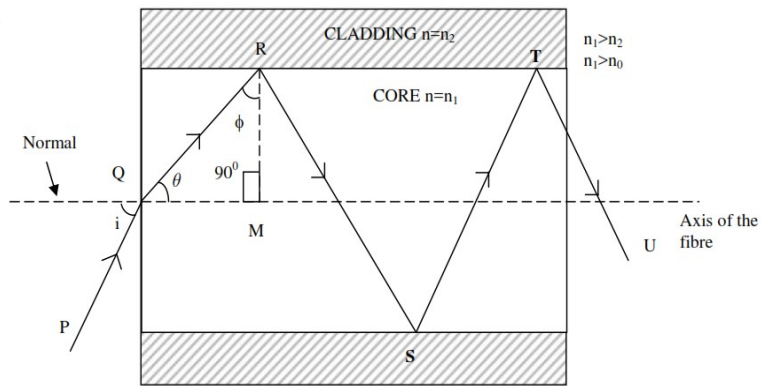

Fig.(3): Propagation of light in optical fiber

The refracted ray makes an angle θ with the normal (axis of the fiber). TU is the ray that emerges from the fiber. The refractive index of the core is n_1 and that of the cladding medium is n_2 ($n_1 > n_2$). The surrounding medium is air and its refractive index is

$$n_0 (n_1 > n_0)$$

For all practical purposes refractive index of air is taken as unity.

Applying Snell's law for the ray of light going from air to core,

$$n_0 \sin i = n_1 \sin \theta$$

$$\frac{\sin i}{\sin \theta} = \frac{n_1}{n_0}$$

$$\sin i = \frac{n_1}{n_0} \sin \theta; n_1 > n_0 \text{ ----- (1)}$$

If the ray QR has to suffer total internal reflection at the core-cladding interface (at the point R).

$$\sin \phi = \frac{n_2}{n_1} \quad (n_1 > n_2) \text{ ----- (2)}$$

Now ΔQRM is a right angle Triangle.

$$\phi = 90 - \theta$$

$$\sin \phi = \sin(90 - \theta) = \frac{n_2}{n_1}$$

$$\sin \phi = \cos \theta = \frac{n_2}{n_1} \text{ ----- (3)}$$

$$\text{But, } \sin^2 \theta = 1 - \cos^2 \theta \Rightarrow \sin \theta = (1 - \cos^2 \theta)^{1/2}$$

$$\sin \theta = \left(1 - \frac{n_2^2}{n_1^2}\right)^{1/2} \text{ ----- (4)}$$

From equations (1) and (4), we get

$$\sin i = \frac{n_1}{n_0} \left(1 - \frac{n_2^2}{n_1^2}\right)^{1/2}$$

$$\sin i = \frac{n_1}{n_0} \left(\frac{n_1^2 - n_2^2}{n_1^2}\right)^{1/2}$$

$$\sin i = \frac{\cancel{n_1}}{n_0} \left(\frac{(n_1^2 - n_2^2)^{1/2}}{\cancel{n_1}}\right)$$

$$\sin i = \left(\frac{n_1^2 - n_2^2}{n_0^2}\right)^{1/2}$$

If $(n_1^2 - n_2^2) \geq n_0^2$, then for all values of i , total internal reflection will occur.

We know that for air, $n_0=1$.

The maximum value of i for which the ray of light guided through the fiber is given by acceptance angle θ_A .

$$\therefore \sin \theta_A = (n_1^2 - n_2^2)^{1/2}$$

$$\therefore \text{Acceptance angle } \theta_A = \sin^{-1} (n_1^2 - n_2^2)^{1/2}$$

Acceptance cone

A cone obtained by rotating a ray of light at the one end face of optical fiber, around the fiber axis with acceptance angle is known as acceptance cone.

Acceptable angle

It is the maximum angle with which a ray of light can enter one end of the fiber and guided through the fiber with total internal reflection. The acceptance angle is denoted by θ_A .

$$\therefore \theta_A = \sin^{-1} \left(n_1^2 - n_2^2 \right)^{1/2}$$

It is a measure of light gathering power of the fiber.

Numerical aperture (NA)

Numerical aperture is the light gathering power of an optical fiber.

Numerical aperture is defined as the Sine of acceptance angle.

\therefore Numerical Aperture = $\text{Sin}\theta_A$

$$N.A. = \left(n_1^2 - n_2^2 \right)^{1/2}$$

Types of optical fibers

Depending on the variation of refractive index of core of an optical fibre, the fibres are classified into two types.

1. Step index fibre
2. Graded index fiber

Again basing on the number of modes (paths) available for the light rays propagating inside the core, the fibers are classified into.

- i) Single mode step index fiber.
- ii) Multimode step index fiber.

Differences between single mode step index fiber and multimode step index fiber

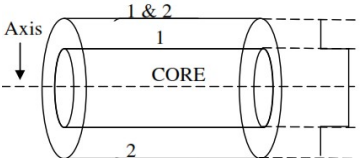
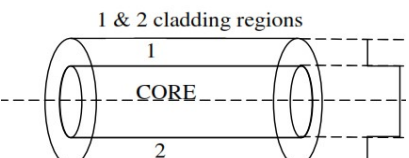
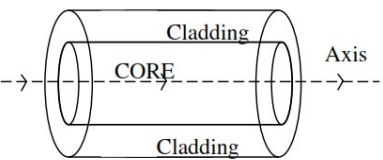
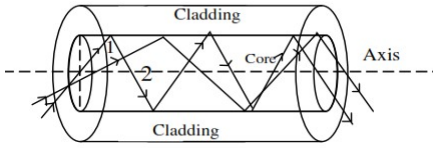
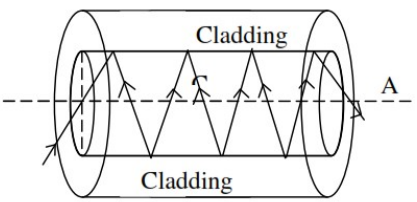
Single mode step index fiber	Multimode step index fiber
<ol style="list-style-type: none"> The refractive index of the core is uniform throughout. In such a fiber the refractive index profile abruptly changes or step changes at the cladding boundary. The diameter of the core is 8-12 μm and that of cladding is 125μm. In a single mode fiber only one mode or path can propagate through the fiber. 	<ol style="list-style-type: none"> The refractive index of the core is uniform throughout. The refractive index profile abruptly changes or step changes at the cladding boundary. The diameter of the core is 50-200 μm and that of cladding is 125-400μm. Multimode fiber allows a large number of paths or modes for the light rays travelling through it.
<ol style="list-style-type: none"> Index profile diagram for the single mode step index fiber is shown below. 1 & 2 are cladding regions. 	<ol style="list-style-type: none"> Index profile diagram for the multimode step index fiber is shown below. 1 & 2 are cladding regions. 
<ol style="list-style-type: none"> The light rays are propagating in the fiber as shown below. 	<ol style="list-style-type: none"> The light rays are propagating in the fiber as shown below. 
<p>Fig. (1) Index profile diagram for step index single mode fiber.</p> <p>Fig. 2. Propagation of light in a single mode step index fiber (or)</p>  <p>Fig.2. proration of light in a</p>	<p>Fig. (1) Index profile diagram for step index multimode mode fiber.</p> <p>Fig. 2. Propagation of light in a multi mode step index fiber</p> <p>Since the core is wider, greater number of light rays enters into the fiber from input signal and takes multiple paths, as shown in fig(2).The light ray (1) which makes greater angle with the axis of the fiber, suffers more number of reflections through the fiber. It takes</p>

single mode step index fiber

Since it has got one mode of propagation, only one ray of light enters into the fiber and traverses a single path or the light ray transverses along the axis of the fiber.

Here the light ray takes only one path, hence there is no signal distortion at the output end.

6. Signal distortion is shown below (No. distortion)

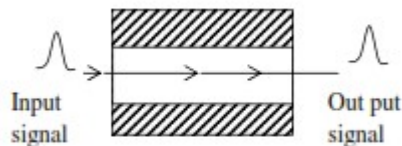

Distortion in the single mode step index fiber

7. The difference between the refractive indices of the core and cladding is very small.
8. Δ Value is small.
9. These fibers are more suitable for communication. This is because of less distortion.
10. Projection of light into single mode fibers and joining of two fibers are very difficult.
11. Fabrication is very difficult and so the fiber is costly.
12. It is a reflective type of fiber.
13. The light rays travel in the form of **meridional rays.**

more time to reach the exit end. Here light travels more distance in the fibre. The ray (2) makes smaller angle with the axis of the fiber, it suffers less number of reflections in a short time. Light ray (2)

traverses a short distance through the fiber. Ray (2) reaches the exit end quickly. Due to a path difference between these two rays, they superimpose at the output end. Hence signals are overlapped.

6. Signal distortion is shown below (Having distortion)

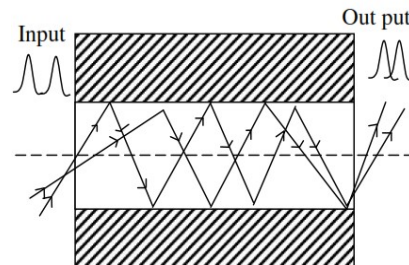

Distortion in the multi mode step index fiber

7. The difference between the refractive indices of the core and cladding is very large.
8. Δ Value is large.
9. These fibers are less suitable for communication. This is because of large distortion.
10. Projection of light into multi mode fibers and joining of two multimode fibers are very easy.
11. Fabrication is less difficult and so the fiber is not expensive.
12. It is a reflective type of fiber.
13. The light rays travel in the form of **meridional rays.**

Differences between step index fiber and graded index fiber

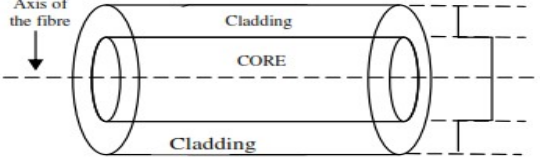
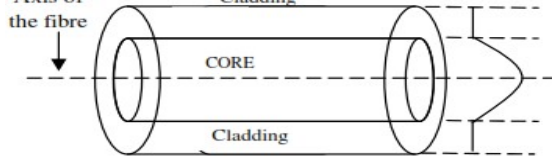
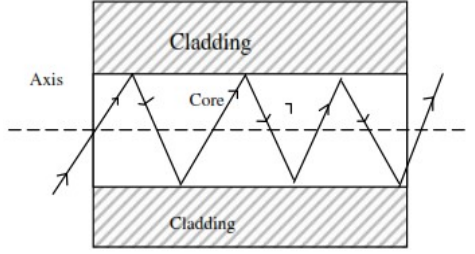
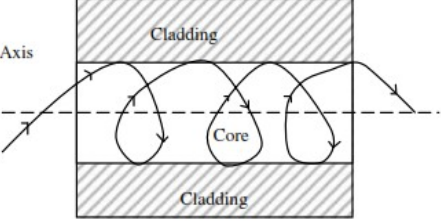
Step index fiber	Graded index fiber
<ol style="list-style-type: none"> The refractive index of the core is uniform throughout. In this fiber the refractive index profile abruptly changes or step changes at the core cladding boundary. Here we have two types of fibers, namely single mode and multimode step index fibers. In the case of single mode step index fiber, the core diameter is about 10μm and that of cladding is 125μm. In the case of multimode step index fiber, the core diameter is 50-200μm and that of cladding is 125-400μm. The index profile diagram is shown below in fig. (1). 	<ol style="list-style-type: none"> The refractive index of the core is not uniform. In a graded index fiber the refractive index varies continuously across the core. It is maximum at the centre of the core and decreases radially towards the outer edge. i.e. the refractive index of the core changes in a parabolic manner. Here we have only one type of fiber, namely multimode fibers. The diameter of the core is about 50 μm and that of cladding is about 125 μm. The index profile diagram is shown below in fig. (1).
	
<p>Figure (1) step index fiber. Index profile diagram.</p> <ol style="list-style-type: none"> It is a reflective type of fiber. The propagation of light rays are in the form of MERIDIONAL rays or zig-zag rays. These rays cross the axis of the fiber a number of times. The Meridional rays are shown below. 	<p>Figure (1) Graded index fiber. Index profile diagram.</p> <ol style="list-style-type: none"> It is a refractive type of fiber. The propagation of light rays are in the form of SKEW rays or helical rays. These rays will never cross the axis of the fiber. The skew rays are shown below.
	
<p>Fig (2) step index fiber meridional rays.</p>	<p>Fig (2) Graded index fiber skew rays. In a graded index fiber, the refractive index of the core decreases from the fiber axis to the cladding interface in a parabolic manner. When a light ray enters into the core and moves towards</p>

In the case of step index fiber, the light rays propagate through the fiber by way of total internal reflection.

8. In a step index fiber the light rays are propagated as shown in figure (3).

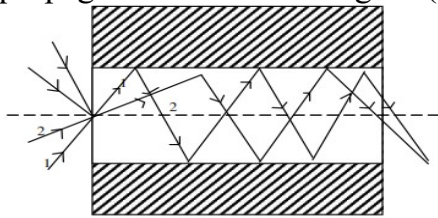

Fig.3 propagation of light in a step index fiber

The two rays will not reach the output end simultaneously hence there is intermodal distortion. The output and input signals are shown in the figure below.

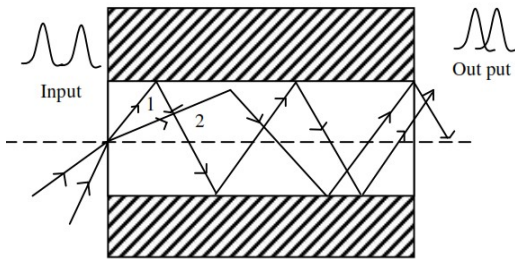

Fig.(4) Input and output signals in a step index fiber

the cladding interface, it encounters a more and more rarer medium due to decrease of refractive index.

As a result, the light ray bends away from the normal and finally bends towards the axis of the fiber. Now it moves towards the core-cladding interface at the bottom.

Again the light ray bends in the upward direction. Thus due to continuous refraction the light ray takes sinusoidal (or) helical path.

8. In a graded index the light rays are propagated as shown in figure (3)

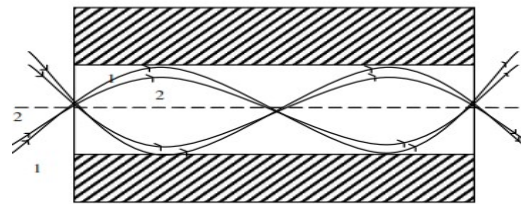

Fig.3 propagation of light in a graded index fiber

When the two light rays (1) and (2) enter into the fiber, by making different angles with the axis of the fiber, their velocities will change continuously and reach the output end simultaneously at the same time i.e. the light rays will come to focus at the same point.

Here there is no intermodal dispersion. The output and the input signals are shown in the figure below.

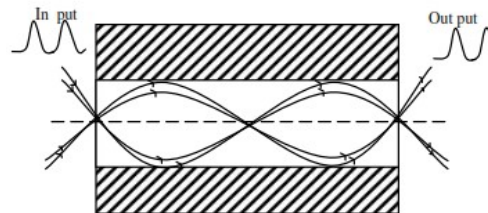

Fig. (4)Input and output signals in a step index fiber

<p>9. Distortion is more due to intermodal dispersion.</p> <p>10. Here there is no self refocusing effect.</p> <p>11. Numerical aperture is more in a multimode step index fiber.</p>	<p>9. Distortion is less.</p> <p>10. Self refocusing effect takes place due to continuous refraction. Hence the helical path for the light rays.</p> <p>11. Numerical aperture is less in a graded index fiber.</p>
---	---

Fiber optic communication system

The block diagram of a fiber optic communication system is shown in figure (1).

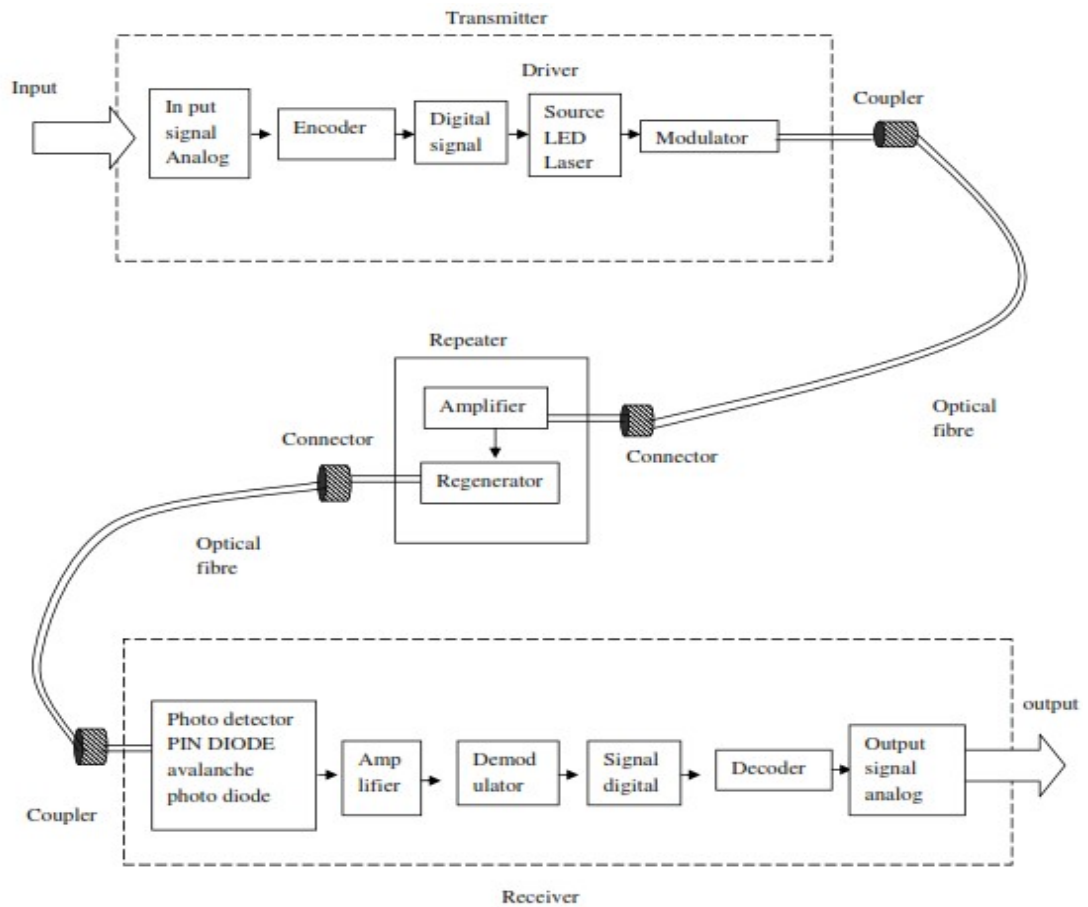

Figure (1) block diagram optical fiber communication system.

The fiber optic communication system consists of the following.

- i) Transmitter
- ii) Repeaters (or) fiber repeaters and
- iii) Receiver iv) couplers and connectors v) fiber cable.

i) The transmitter: or an **optical transmitter** consists of an Encoder, a source of light and modulator. The input signal in the form of speech or song is fed to an encoder. The encoder converts the analog signal into a digital signal.

The digital signal is given to the source of light. The source of light can be a light emitting diode (LED) or a pn junction laser diode.

The optical carrier signal is now finally fed to modulator. The modulator modulates the signal depending on the requirement.

The type of modulation may be amplitude or frequency or phase modulation.

The optical signal finally coupled to the optical fiber with the help of couplers.

The couplers launch the optical signal in the fiber without any distortion.

The fiber is connected to the repeater with the help of connector.

ii) The repeater: It consists of an amplifier and a regenerator.

During the transmission of the signal, along the optical fiber, there will be loss in the signal due to dispersion in the fiber. As a result we get a weak signal at the output end of the fiber. To minimize the losses, repeaters are employed at regular intervals along the fiber. Now in the repeater the amplifier amplifies the signal and is reconstructed through the fiber.

Finally the optical signal is fed to the receiver.

iii) The receiver: consists of a photo detector. The photo detector consists of a PIN diode or avalanche photo diode.

From the fiber the optical signal is fed to the photo detector. The photo detector detects the optical signal and converts it into an electrical signal.

The electrical is the amplified by the amplifier the amplified signal is fed to the Demodulator. The demodulator demodulates the signal to get a digital signal. This digital signal is decoded by a Decoder.

The output of the decoder is a pure form of the original signal. This is taken as final output.

Applications of optical fibers:

1. Optical fibers are used in fiber optic communication systems.
2. Optical fibers are used in exchange of information between different terminals in a network of computers.
3. They are used to carry information and exchange information in cable television networks, Space vehicles and submarines etc.
4. Optical fibers are used in industry in security alarm systems, process control and industrial automation.
5. Optical fibers are used in optical fiber gyroscopes and are used in automotive navigation systems.

6. They are used in pressure sensors in biomedical applications.
7. Used in pressure sensors in Engine control applications.
8. Optical fibers are used in medicine in the fabrication of fiberscope in endoscopy.
The endoscopy is used to visualize internal parts of the body.
9. They are used in fuel tanks to sense the liquid levels as a liquid level sensor.
10. They will be used as chemical sensors.

Fractional Refractive Change (or) Relative refractive indices Difference (Δ)

Numerical aperture is given by

$$N.A. = (n_1^2 - n_2^2)^{1/2}$$

$$(N.A.)^2 = (n_1^2 - n_2^2)$$

$$(N.A.)^2 = (n_1 + n_2)(n_1 - n_2)$$

Usually for any fiber $n_1 \approx n_2$, $n_1 + n_2 = 2n_1$

$$(NA)^2 = 2n_1(n_1 - n_2)$$

Multiplying and dividing with n_1 , we get

$$(NA)^2 = \frac{2n_1^2(n_1 - n_2)}{n_1}$$

$$(NA)^2 = 2n_1^2(\Delta) \Rightarrow \therefore NA = n_1\sqrt{2\Delta}$$

Where, $\Delta = \frac{n_1 - n_2}{n_1}$, called Relative refractive indices difference.

Prepared By

P.V.Ramana Moorthy
Associate Professor,
SITAMS, Chittoor