

measurement was made, or the conditions assumed in calculating it, if any possible question could exist.

An antenna mounted so that earth-reflection interference effects occur will have its vertical-plane pattern drastically affected, as Fig. 1–15 indicates. Horizontal-plane patterns may be affected as to absolute values, but relative values will not be affected if the earth in the vicinity is “smooth.” That is, the *shape* of the horizontal pattern will not be affected, unless the earth is irregular.

3.3. Directivity and Gain

In discussions of directivity and gain, the concept of an isotropic radiator, or isotrope, is fundamental. This concept was introduced briefly in sec. 1.1.4. Essentially an isotrope is an imaginary, lossless antenna that radiates uniformly in all directions. Its pattern is a perfect spherical surface in space; that is, if the electric intensity of the field radiated by an isotrope is measured at all points on an imaginary spherical surface with the isotrope at the center (in free space), the same value will be measured everywhere. Therefore, if an isotrope radiates a total power P_t in watts and is located at the center of a transparent (or imaginary) far field sphere of radius R meters, the power density over the spherical surface is

$$P_{isotrope} = \frac{P_t}{4\pi R^2} \text{ watts per square meter} \quad (3-11)$$

Equation (3–11) is true because P_t is distributed uniformly over the surface area of the sphere, which is $4\pi R^2$ square meters.

Actually an isotropic radiator is not physically realizable; all actual antennas have some degree of nonuniformity in their radiation patterns. A nonisotropic antenna will radiate more power in some directions than in others and therefore has a directional pattern. A directional antenna will radiate more power in its direction of maximum radiation than an isotrope would, with both radiating the same total power. Thus, since the directional antenna sends less power in some directions than an isotrope does, it follows that it must send more power in other directions, if the total powers radiated are the same.

Directivity D is a quantitative measure of an antenna’s ability to concentrate radiated power per unit solid angle in a certain direction, and thus D is highly dependent on the three-dimensional pattern of an antenna. D will be explicitly defined in materials that follow. On the other hand, gain G is the ratio of the power radiated per unit solid angle to the power per unit solid angle radiated by a lossless isotrope, each having the same input power. Unless otherwise specified, the direction applicable to D and G is that for which maximum radiation occurs.

Over the years there have been several gain-related terms used. In fact, gain once was not defined in terms of signal strength relative to any specific antenna type (Terman 1943). Gain is sometimes specified relative to the gain of a one-half wavelength dipole, whose gain exceeds the isotrope by the factor 1.64 (2.15 dB). Then, gain is specified in

dB_d (gain above the gain of a lossless one-half wavelength dipole). However, almost universally, gain is expressed relative to the lossless isotrope and when specificity is desired, it is referred to as absolute gain or expressed in terms of dB_i .

3.3.1. Definitions of Directivity and Gain

The IEEE definitions of directivity and gain are expressed in terms of radiation intensity $U(\theta, \phi)$, which is a range-independent quantity that is the product of power density $p(\theta, \phi, r)$ and range squared r^2 , that is, $U(\theta, \phi) = p(\theta, \phi, r)r^2$. Specifically,

- Directivity is the ratio of the radiation intensity in a given direction from the antenna to the radiation intensity averaged over all directions (IEEE 1993, p. 362). *Notes:* (1) The average radiation intensity is equal to the total power radiated by the antenna divided by 4π (area of sphere in steradians). (2) If the direction is not specified, the direction of maximum radiation intensity is implied.
- Gain is the ratio of the radiation intensity, in a given direction, to the radiation intensity that would be obtained if the power accepted by the antenna were radiated isotropically (IEEE 1993, p. 547). *Notes:* (1) Gain does not include losses arising from impedance and polarization mismatches. (2) If the antenna is without dissipative (I^2R) losses; then, in any given direction its gain is equal to its directivity. (3) If the direction is not specified, the direction of maximum radiation intensity is implied.

Sections 3.3.2 through 3.3.5 that follow discuss the mathematics of directivity and gain, and relationships between them. To accomplish this, the concepts of solid angle and radiation intensity are first introduced.

3.3.2. Solid Angle

Solid angle is the angle that, seen from the center of a sphere, includes a given area on the surface of the sphere. The value of the solid angle is numerically equal to the size of that area divided by the square the radius of the sphere (Jurgenson and Brown 2000). Mathematically the solid angle is unitless, but for practical reasons the steradian (s.r.) is assigned so that 1 steradian = 1 radian². Since radians are dimensionless, steradians are also dimensionless.

Figure 3–4 shows a cross-hatched area dA in spherical coordinates that is bisected by the solid angle $d\Omega$. Since $dA = r^2 \sin \theta d\theta d\phi = r^2 d\Omega$, the value of the cross-hatched solid angle in Fig. 3–4 is $d\Omega = \sin \theta d\theta d\phi$. In general, however, solid angles can have other shapes. The solid angle of area A/r^2 that subtends all of a sphere may be determined as follows:

$$\Omega = \frac{A}{r^2} = \int_0^{2\pi} \left[\int_0^{\pi} \sin \theta d\theta \right] d\phi = \int_0^{2\pi} 2d\phi = 4\pi \quad (3-12)$$

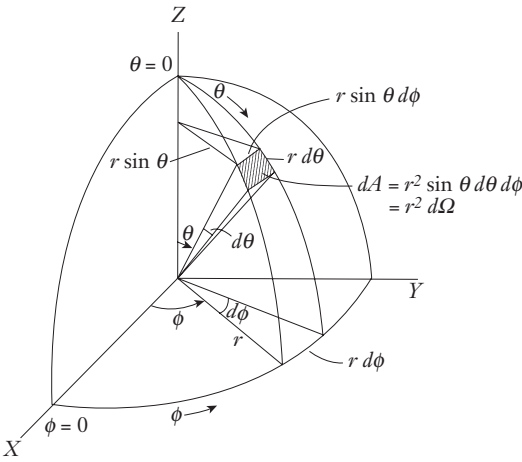

FIGURE 3-4.

The solid angle $d\Omega$ subtends area dA , and consequently the solid angle $d\Omega = r^2 \sin \theta d\theta$.

P can be determined by summing the incremental power $p(\theta, \phi, r)dA$ over the surface, as follows:

$$P = \oint_{\text{surface}} p(\theta, \phi, r)dA = \int_0^{2\pi} \int_0^\pi p(\theta, \phi, r)r^2 \sin \theta d\theta d\phi \tag{3-13}$$

The power density varies as $1/r^2$, and thus the product $p(\theta, \phi, r)r^2$ is independent of distance r from antenna. This range-independent product is defined as the radiation intensity U . Therefore

$$U(\theta, \phi) = p(\theta, \phi, r)r^2 \tag{3-14}$$

and the incremental power that crosses surface area dA is

$$dP = p(\theta, \phi, r)dA = p(\theta, \phi, r)r^2 \sin \theta d\theta d\phi = U(\theta, \phi)d\Omega$$

where $d\Omega = \sin \theta d\theta d\phi$. Thus, the radiation intensity $U(\theta, \phi)$ is $dP/d\Omega$, that is, the incremental power per unit solid angle in direction (θ, ϕ) . $U(\theta, \phi)$ is usually expressed in units of watts per steradian (i.e., watts per square radian). Then, from (3-13) and (3-14), total radiated power P is

$$P = \int_0^{2\pi} \int_0^\pi p(\theta, \phi, r)r^2 \sin \theta d\theta d\phi = \int_0^{2\pi} \int_0^\pi U(\theta, \phi)d\Omega \tag{3-15}$$

3.3.3. Radiation Intensity

The power P radiated by an antenna is equal to $p(\theta, \phi, r)dA$ integrated over a surface enclosing the antenna, where

r = distance from origin to surface of sphere

$p(\theta, \phi, r)$ = power density at θ, ϕ , and r

$dA = r^2 \sin \theta d\theta d\phi$ = incremental area at θ, ϕ , and r normal to the propagation direction

$p(\theta, \phi, r)dA$ = incremental power in area dA at θ, ϕ , and r

Now, using the coordinates of Fig. 3-4, let an antenna be at the center of the sphere. Then, the total radiated power

In other words, total radiated power equals the sum of all radiation intensity that encloses the antenna.

3.3.4. Directivity

Directivity D is a quantitative measure of an antenna's ability to concentrate energy in a certain direction. Specifically, D is the ratio of the maximum radiation intensity U_{max} to the average radiation intensity U_{av} . Then

$$\text{Directivity} = U_{max}/U_{av} \quad (\text{dimensionless}) \quad (3-16)$$

If the radiation is isotropic, the radiation intensity in every direction is U_{av} . Thus, from (3-12) and (3-15), total radiated power P is a sphere's solid angle 4π times U_{av} and is given by (3-17)

$$P = 4\pi U_{av} \quad (3-17)$$

Now, by using (3-15), (3-16) and (3-17), directivity can be expressed as

$$\frac{U_{max}}{U_{av}} = \frac{4\pi U_{max}}{P} = \frac{4\pi U_{max}}{\int_0^{2\pi} \int_0^{\pi} U(\theta, \phi) \sin \theta d\theta d\phi} \quad (3-18)$$

Now, by shifting the constant U_{max} to the denominator, it is seen from (3-19) that D is a function the relative value on $U(\theta, \phi)$ (the bracketed term) that has a maximum of unity:

$$D = \frac{4\pi}{\int_0^{2\pi} \int_0^{\pi} \left[\frac{U(\theta, \phi)}{U_{max}} \right] \sin \theta d\theta d\phi} \quad (3-19)$$

The bracketed term of (3-19) can be replaced by functions, at a fixed distance, of power density $p(\theta, \phi, r)$ or electric field strength $E(\theta, \phi, r)$. This is because, with r constant,

$$U(\theta, \phi)/U_{max} = p(\theta, \phi, r)/p(\theta, \phi, r)_{max} = |E(\theta, \phi, r)/E(\theta, \phi, r)_{max}|^2 \quad (3-20)$$

Therefore, with r fixed, D can be determined with relative values of either $U(\theta, \phi)$, $p(\theta, \phi, r)$, or $|E(\theta, \phi, r)|^2$.

It is also to be noted that directivity D of (3-19) can be expressed as

$$D = \frac{4\pi}{\Omega_A} \quad (3-21)$$

where Ω_A is known as the beam solid angle. For the special case of an isotrope, since an isotrope radiates equally in all directions, $\Omega_A = 4\pi$ and $D = 1$. In general, however,

$$\Omega_A = \int_0^{2\pi} \int_0^\pi \left[\frac{U(\theta, \phi)}{U_{max}} \right] \sin\theta d\theta d\phi \quad (3-22)$$

and with r constant, $U(\theta, \phi)/U_{max}$ can be replaced with either $p(\theta, \phi, r)/p(\theta, \phi, r)_{max}$ or $|E(\theta, \phi, r)/E(\theta, \phi, r)_{max}|^2$. Use of the term Ω_A in (3-21) helps to emphasize that directivity is a measure of an antenna's ability to concentrate energy in a certain direction. Finally, it is important to again underscore that directivity is calculated by integrating relative values of an antenna's radiation pattern, and this does not require knowledge of an absolute value.

3.3.5. Gain

Gain, previously defined in sec. 3.3.1, is the ratio of the radiation intensity in a given direction to the radiation intensity that would be obtained if the power were radiated isotropically. If the direction is not specified, the direction of maximum radiation intensity U_{max} is implied. In addition, for isotropically radiated power, the radiation intensity is U_{av} . Therefore, for a lossless antenna, gain G equals directivity as defined previously by (3-16).

Gain is determined, in principle, by comparing the radiation intensity if both the actual test antenna and an isotrope have the same input power. The isotrope is assumed to radiate all of its input power, but some of the power delivered to the actual antenna may be dissipated in ohmic resistance (i.e., converted to heat). Thus, gain takes into account the antenna efficiency as well as its directional properties. The efficiency factor k is the ratio of the power radiated by the antenna to the total input power. Thus, the relationship between gain G and directivity D is

$$G = kD \quad (3-23)$$

where $0 \leq k \leq 1$ to account for dissipative (I^2R) losses.

It is apparent that the quantity of greatest significance to a system designer is gain. The antenna theorist, on the other hand, finds the concept of directivity convenient, for it depends only upon the pattern of the antenna. The theorist can compute the directive gain of a half-wave dipole, for example, by application of Maxwell's equations and the assumption that the dipole has no ohmic loss. The directivity of an isotrope, incidentally, is by definition unity, and the gain of an isotrope with efficiency factor k is (also by definition) equal to k .

Antenna gain is a power ratio. Values of gain of practical antennas may range from near zero (total loss) to as much as 10^6 or more. As with any power ratio, antenna gain may be expressed in decibels. The antenna gain G expressed in decibels is $G_{dB} = 10 \log G$,

where the word *log* denotes the common logarithm (base 10). Directivity in decibels is calculated using the same formula, with D substituted for G . Gain is expressed in decibels more commonly than as a power ratio.

3.4. Effective Area and Friis Transmission Equation

Although there is a reciprocal relationship between the transmitting and receiving properties of *reciprocal* antennas, it is sometimes more convenient to describe the receiving properties in a somewhat different way. Whereas the gain is the natural parameter to use for describing the increased power density of the transmitted signal due to the directional properties of the antenna, a related quantity called the *effective area*, is a more natural parameter for describing the reception properties of the antenna.

The effective area of an antenna A_e is defined as follows. Suppose that a distant transmitter radiates a signal that, at the receiving-antenna location, has a power density p_r . This is the amount of power incident on, or passing through, each *unit area* of any imaginary surface perpendicular to the direction of propagation of the waves.

A receiving antenna exposed to this field will have radio-frequency current and voltage induced in it, and at the antenna terminals this voltage and current represent radio-frequency power that can be delivered to a load (e.g., the input circuit of a receiver). In principle the power available at these terminals can be measured (although in practice it may be so small a power that amplifying equipment will be needed to measure it). This power, however small, is the *received signal power*, P_r . It can be deduced that in order for this amount of power to appear at the antenna output terminals, the antenna had to “capture” power from the field over a surface in space (oriented perpendicularly to the direction of the wave) of area A_e such that

$$P_r = p_r A_e \quad (3-24)$$

The area A_e , which bears this relationship to P_r and p_r , is the effective area of the antenna. (The conception of the capture process thus conveyed is a much oversimplified one, but it has validity for the present purposes.) Since received power depends on the antenna polarization, effective area is a function of the polarization of the incident field.

As might be supposed, there is a connection between the effective area of an antenna and its physical area as viewed from the direction of the incoming signal. The two areas are not equal, however, although for certain types of high-gain antennas they may be nearly equal. But some antennas of physically small cross section may have considerably larger effective areas. It is as though such an antenna has the ability to “reach out” and capture power from an area larger than its physical size, as in the case of a dipole antenna.

As is discussed in sec. 5.7.6, there is also a relationship between the gain of a lossless antenna and its physical size. This relationship suggests that there may also be a connection between the gain and the effective area, and this indeed turns out to be true. The equation relating the two quantities is

$$A_e = \frac{G\lambda^2}{4\pi} \quad (3-25)$$

where λ is the wavelength corresponding to the frequency of the signal. (This relationship may be proved theoretically and verified experimentally.)

Because of this connection between the effective area and the gain, (3-24) may be rewritten, with the right-hand side of (3-25) substituted for A_e . Thus:

$$P_r = \frac{p_r G \lambda^2}{4\pi} \quad (3-26)$$

Therefore the concept of the effective area of an antenna is not a necessary one. As (3-26) shows, it is possible to calculate the received-signal power without knowing A_e . As seen, the effective area definition has a conceptual value, however, and is a convenient quantity to employ in some types of problems. We now consider the relationship between transmit and receive powers with two antennas separated by far-field distance R . This relationship is highly useful, and it is known as the Friis Transmission Equation (Friis 1946). The following abbreviations are used:

- P_r = received power
- P_t = input power of transmit antenna
- A_{et} = effective aperture of transmit antenna
- A_{er} = effective aperture of receive antenna
- G_t = gain of transmit antenna
- G_r = gain of receive antenna

Now, from equation (3-11) for a lossless isotropic radiator and the definition of gain, the power density p_r at distance R from a transmit antenna may be expressed as $(P_t/4\pi R^2)G_t$. Recall that another antenna in the presence of p_r will receive power P_r that equals $p_r A_{er}$. Thus P_r becomes $(P_t/4\pi R^2)A_{er}G_t$. Finally, we use relationships, based on (3-25), between G_r and A_{er} and between G_t and A_{et} to express P_r as functions of $A_{et}A_{er}$ and of G_tG_r . The result is the Friis Transmission Equation which is given in (3-27) that follows.

$$P_r = \left(\frac{P_t}{4\pi R^2} \right) A_{er} G_t = P_t \frac{A_{et} A_{er}}{R^2 \lambda^2} = P_t \frac{G_t G_r \lambda^2}{(4\pi)^2 R^2} \quad (3-27)$$

When reciprocity applies, as is usually so, the effective transmit aperture area A_{et} of an antenna equals its effective receive aperture area A_{er} . Similarly, transmit gain G_t and receive gain G_r of an antenna are equal. Then, because of reciprocity, the transmitter and receiver locations can be interchanged. Thus, either antenna can be designated as the transmit antenna and the other as the receive antenna.

Equation (3-27) underscores the practical significance of gain. For example, a transmit power of 1,000 watts and a transmit antenna gain of 10 (10 dB) will provide the same received power as will a transmit power of 500 watts and a transmit antenna gain of 20

(13 dB). Obviously, this relationship has great economic significance. Sometimes it may be much less expensive to double antenna gain (add 3 dB) than it would be to double transmit power (though in other cases the converse may be true). Generally, it is desirable to use as much antenna gain as feasible, because it increases received signals.

3.5. Beamwidth

When the radiated power of an antenna is concentrated into a single major “lobe,” as exemplified by the pattern of Fig. 3–2, the angular width of this lobe is the *beamwidth*. The term is applicable only to antennas whose patterns are of this general type. Some antennas have a pattern consisting of many lobes, for example, all of them more or less comparable in their maximum power density, or gain, and not necessarily all of the same angular width. One would not speak of the beamwidth of such an antenna, but a large class of antennas do have patterns to which the beamwidth parameter may be appropriately applied.

3.5.1. Practical Significance of Beamwidth

If an antenna has a narrow beam and is used for reception, it can be used to determine the direction from which the received signal is arriving, and consequently it provides information on the direction of the transmitter. To be useful for this purpose, the antenna beam must be “steerable,” that is, capable of being pointed in various directions. It is intuitively apparent that for this direction-finding application, a narrow beam is desirable and the accuracy of direction determination will be inversely proportional to the beamwidth, assuming no errors in other parts of the system (although in practice this is not always a good assumption). Its relation to direction-finding accuracy is one significant aspect of the beamwidth parameter. This, however, is by no means its only practical significance.

In some applications a receiver may be unable to discriminate completely against an unwanted signal that is either at the same frequency as the desired signal or on nearly the same frequency. In such a case, pointing a narrow receiving-antenna beam in the direction of the desired signal is helpful; the resulting greater gain of the antenna for the desired signal, and reduced gain for the undesired one, may provide the necessary discrimination. If the directions of the desired and undesired signals are widely separated, even a relatively wide beam will suffice. But the closer the two signals are in direction, the narrower the beam must be to provide effective discrimination. (In radar systems the analogous problem is the ability to distinguish two targets that are close together in bearing, that is, in direction angle; this ability is called angular resolving power or resolution.)

Finally, as the foregoing discussion of gain and directivity (sec. 3.3) indicated, there is a relationship between the solid-angle width of an antenna beam and its directivity (also see sec. 3.11). Thus, with some exceptions, generally a narrower beam implies a greater gain. Since gain is usually a desirable property, this relationship constitutes an additional virtue of narrow beamwidth.

On the other hand, there are situations that call for a wide beam. For example, a broadcasting station must radiate a signal simultaneously to listeners in many different directions—typically, over a 360 degree azimuth sector. Any narrowing of the beam to obtain gain must therefore be done in the vertical plane. At the low frequencies of the AM broadcast band (535–1,705 kHz), and at lower frequencies, such vertical-plane beam narrowing is not feasible because it would require an impractically large (high) antenna. In television and FM broadcasting in the VHF and UHF bands, however, this means of obtaining gain while preserving 360 degree azimuthal coverage is much used. A situation in which an antenna beam must be moderately broad in the vertical plane is that of a search radar antenna on a ship that rolls and pitches. It is usually required that the beam of such antenna be directed at the horizon. But if the beam has, say, a 2-degree vertical beamwidth, and the ship rolls 20 degrees (which is not unusual), it is evident that at times no part of the beam will remain directed at the horizon. The vertical beamwidth in this case must be of size comparable to the maximum roll angle of the ship, unless some method of stabilizing the beam is employed (as is sometimes done).

3.5.2. Beamwidth Definition

As illustrated in Fig. 3–2, an antenna beam is typically round-nosed. Defining beamwidth, therefore, is a problem. As seen clearly in the rectangular plot, Fig. 3–2b, it would be possible in this case to cite the width of the beam between the two nulls (zero values) on either side of the maximum, since these are two definitely measurable points. Not all beams have such nulls, however, although they are present ordinarily. Moreover, it is logical to define the width of a beam in such a way that it indicates the angular range within which radiation of useful strength is obtained, or over which good reception may be expected. From this point of view the convention has been adopted of measuring beamwidth between the points on the beam pattern at which the power density is half the value at the maximum. (On a plot of the electric-intensity pattern, the corresponding points are those at which the intensity is equal to $1/\sqrt{2}$ or 0.707 of the maximum value.)

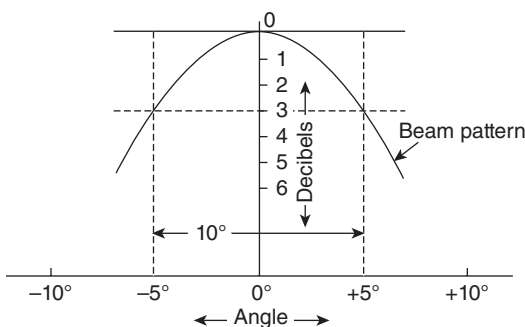

FIGURE 3–5.

Determination of half-power (3 dB down) beamwidth.

The angular width of the beam between these points is called the *half-power beamwidth*. When a beam pattern is plotted with the ordinate scale in decibels, as is frequently done, the half-power points correspond to the minus 3 dB points. For this reason the half-power beamwidth is often referred to as the *3 dB beamwidth*. Figure 3–5 illustrates the procedure of determining the 3 dB beamwidth on a rectangular pattern plot. Only the nose region of the beam pattern is shown. As indicated, this beamwidth is approximately 10 degrees.

This criterion of beamwidth, although adequate and convenient in many situations, does not always provide a sufficient description of the beam characteristics. Beams have different shapes. An additional description may be given by measuring the width of the beam at several points, for example, at -3 dB, -10 dB, and at the nulls (if they are present). Some beams may have an asymmetric shape, for some special reason, and the specific nature of the asymmetry may be important. Special methods of describing such beams can be employed. In the final analysis the best description of a beam is a plot of its pattern.

3.5.3. Principal-Plane Beamwidths

An antenna beam occupies a solid angle, and a single beamwidth figure refers only to the pattern in a particular plane. It is apparent that the beam may have different widths in different planes through the beam axis. (The axis is the direction of maximum radiation, a line from the antenna passing through the nose of the beam.) Therefore it is customary to give the widths of the beam in two planes at right angles, usually the principal planes of the coordinate system. The beamwidths in planes at intermediate angles will generally have intermediate values, so that giving just these two beamwidth figures conveys considerable information concerning the solid-angular shape of the beam. When the beam is linearly polarized, the beamwidth in the plane containing the E -vector (plane of polarization) is sometimes called the E -plane beamwidth, and that in the perpendicular plane the H -plane beamwidth.

3.6. Minor Lobes

A directional antenna usually has, in addition to a main beam or major lobe of radiation, several smaller lobes in other directions; they are *minor lobes* of the pattern. Those adjacent to the main lobe are *sidelobes*, and those that occupy the hemisphere in the direction opposite to the main-beam direction are *back lobes*. Minor lobes ordinarily represent radiation (or reception) in undesired directions, and the antenna designer therefore attempts to minimize their level relative to that of the main beam. This level is expressed in terms of the ratio of the power densities in the mainbeam maximum and in the strongest minor lobe. This ratio is often expressed in decibels.

Since the sidelobes are usually the largest of the minor lobes, this ratio is often called the sidelobe ratio or sidelobe level. A typical sidelobe level, for an antenna in which some attempt has been made to reduce the sidelobe level, is 20 dB, which means that the power density in the strongest sidelobe is one percent of the power density in the main beam. Sidelobe levels of practical well-designed directional antennas typically range from about 13 dB (power-density ratio 20) to about 40 dB (power-density ratio 10^4). Attainment of a sidelobe level better than 30 dB requires very careful design and construction, but better than 50 dB (10^5) has sometimes been accomplished.

Figure 3–6 shows a typical antenna pattern with a main beam and minor lobes, plotted on a decibel scale to facilitate determination of the sidelobe level, which is here seen to be 25 dB.

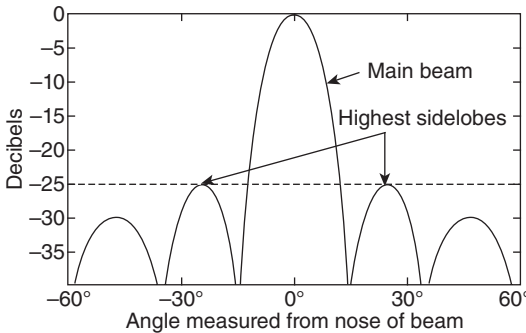

FIGURE 3-6.

Decibel pattern plot, indicating sidelobe level.

Sidelobe echoes create “clutter” on the radar output that may mask main-beam echoes from smaller targets and overload the data-processing personnel or equipment. Therefore radar antennas are often designed for sidelobe levels of -25 dB or better in the horizontal-plane patterns. Sidelobes in the vertical-plane patterns may also be harmful in height finding radars but do no harm in search radars that provide angle information only in the azimuth plane, except to the extent that they represent wasted power.

In some applications sidelobes are not especially harmful unless their level becomes comparable to the main-beam level; in other applications it may be important to hold the sidelobe level to an absolute minimum. In most radar systems, for example, a low sidelobe level is important. Since signals received in a sidelobe are ordinarily indistinguishable from signals received from the main beam, a large target located in the direction of one of the antenna sidelobes (or even a back lobe) may appear to the radar as though it were a target in the main beam. Such sid-

3.7. Radiation Resistance and Efficiency

In a large class of antennas the radiation is associated with a flow of rf current in a conductor or conductors. Thus, when a current I flows in a resistance R , an amount of power $P = RI^2$ will be dissipated and converted into heat. In an antenna, even if there were no resistance in the conductors, the electrical energy supplied by the transmitter is radiated and it is in a sense “lost.” It is customary to associate this “loss” of power through radiation with a fictitious “radiation resistance,” that bears the same relationship to the current and the radiated power as an actual resistance bears to the current and dissipated power. If the power radiated by the antenna is P and the antenna rms current is I , the radiation resistance is

$$R_r = \frac{P}{I^2} \quad (3-28)$$

The concept of radiation resistance is applicable only to antennas in which the radiation is associated with a definite current in a single linear conductor. Even then, the definition of radiation resistance is ambiguous. This is because of standing waves, the current is not the same everywhere along a linear conductor. It is therefore necessary to specify the point along the conductor at which the current will be measured. Two points sometimes specified are where the current has its maximum value and the feed point (input terminals). These two points are sometimes at the same place, as in a center-fed dipole,

but they are not always the same. And in principle, *any* point may be specified. The value then obtained for the radiation resistance of the antenna depends on what point is specified; this value is the radiation resistance *referred to that point*.

The above words “maximum current” refer to the rms current in that part of the antenna where the current is maximum. It does *not* mean the *peak* value of the current located where the current is greatest. The reader will recall that, in accordance with equation (1–3), by definition the *amplitude* I_0 of a current sine wave is actually the peak value of current during its cycle. Furthermore, the reader is cautioned that, in some texts, formulas for radiation resistance are written as a function of current “amplitude” I_0 , instead of rms current. Thus, use of the wrong combination of formula and current level will cause the radiation resistance to be incorrectly calculated.

The radiation resistance of some types of antennas can be calculated, and yet not for others. Sometimes radiation resistance can be obtained by measurement (see section 9.10, chapter 9). Typical values of the input radiation resistance of actual antennas range from a fraction of an ohm to several hundred ohms. The very low values are undesirable, because they imply large antenna currents (i.e., $P = I^2R$). Therefore, there exists the possibility of considerable ohmic loss of power, that is, dissipation of power as heat rather than as radiation. An excessively high value of radiation resistance is also undesirable, because this requires that a very high voltage (i.e., $P = E^2/R$) be applied to the antenna.

Antennas always have ohmic resistance, although sometimes it may be so small as to be negligible. The ohmic resistance is usually distributed over the antenna; and since the antenna current varies, the resulting loss may be quite complicated to calculate. In general, however, the actual loss can be considered to be equivalent to the loss in a fictitious lumped resistance placed in series with the radiation resistance. If this equivalent ohmic loss resistance is denoted by R_0 , the full power (dissipated plus radiated) is $I^2(R_0 + R_r)$, whereas the radiated power is I^2R_r . Hence the antenna radiation efficiency k of (3–23) is given by

$$k_r = \frac{R_r}{R_0 + R_r} \quad (3-29)$$

It must be acknowledged, however, that this definition of the efficiency is not really very useful even though it may occasionally be convenient. The fact is that both R_0 and R_r are fictitious quantities, derived from measurements of current and power; R_r is given in these terms by (3–28), and R_0 is correspondingly equal to P_0/I^2 . Making these substitutions into (3–29) gives the more basic definition of the efficiency:

$$k_r = \frac{P_r}{P_0 + P_r} \quad (3-30)$$

where P_r is the power radiated, and P_0 is the power dissipated.

INTRODUCTION TO TL

- Primary constants.
- Secondary constants.
- TL equation.
- Infinite line
- Distortion less line.
- SC & OC lines.
- UHF Lines.
- Any termination.
- Termination by load.

TABLE 11.2 Transmission Line Characteristics

Case	Propagation Constant $\gamma = \alpha + j\beta$	Characteristic Impedance $Z_o = R_o + jX_o$
General	$\sqrt{(R + j\omega L)(G + j\omega C)}$	$\sqrt{\frac{R + j\omega L}{G + j\omega C}}$
Lossless	$0 + j\omega\sqrt{LC}$	$\sqrt{\frac{L}{C}} + j0$
Distortionless	$\sqrt{RG} + j\omega\sqrt{LC}$	$\sqrt{\frac{L}{C}} + j0$

$$Z_o = R_o = \sqrt{\frac{L}{C}}$$

$$\beta = \omega\sqrt{LC} \quad \frac{R_o}{\beta} = \frac{1}{\omega C} \quad L = R_o^2 C :$$

FREQUENCY SPECTRUM

- ITU-International Telecommunication Union Bands.
- IEEE- Institute of Electrical and Electronics Engineers Association Standard Bands.

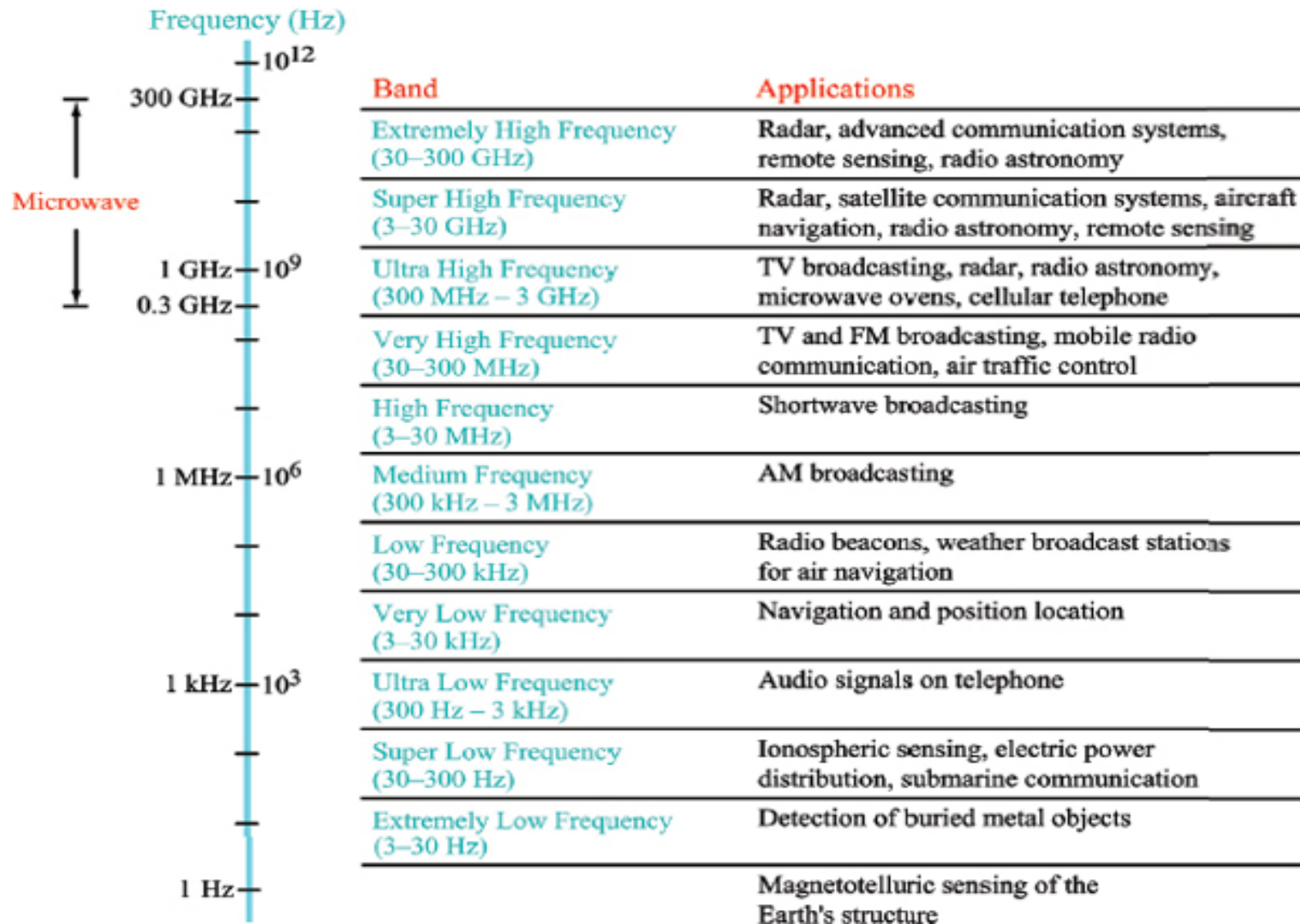

Frequency Band	Designation	Example uses
3–30 Hz	Extremely low frequency (ELF)	Submarine communication
30–300 Hz	Super low frequency (SLF)	Submarine communication
300–3000 Hz	Ultra low frequency (ULF)	Submarine communication
3–30 kHz	Very low frequency (VLF)	Submarine communication
30–300 kHz	Low frequency (LF)	AM longwave broadcasting, RFID
300–3000 kHz	Medium frequency (MF)	AM (medium-wave) broadcasts
3–30 MHz	High frequency (HF)	Shortwave broadcasts, aviation communications, RFID,
30–300 MHz	Very high frequency (VHF)	FM, television broadcasts
300–3000 MHz	Ultra high frequency (UHF)	TV broadcasts, mobile phones, wireless LAN, Bluetooth
3–30 GHz	Super high frequency (SHF)	microwave devices/communications, wireless LAN
30–300 GHz	Extremely high frequency (EHF)	microwave remote sensing

S.No	Band No.	Abbreviation	Frequency Range	Wavelength
1	4	VLF	3-30KHz	10 to 100Km
2	5	LF	30-300 KHz	1 to 10Km
3	6	MF	300-3000KHz	100 to 1000m
4	7	HF	3-30 MHz	10 to 100m
5	8	VHF	30-300 MHz	1 to 10m
6	9	UHF	300-3000 MHz	10 to 100cm
7	10	SHF	3-30 GHz	1 to 10cm
8	11	EHF	30-300 GHz	1 to 10 mm
9	12	THF	300-3000 GHz	0.1 to 1mm

ITU BANDS

S.No	Band Description	Frequency range (GHz)	Abbreviation
1	HF	0.003-0.03	High frequency
2	VHF	0.03-0.3	Very High frequency
3	UHF	0.3-1	Ultra High Frequency
4	L	1-2	Long wave
5	S	2-4	Short wave
6	C	4-8	Compromise between S and L
7	X	8-12	X for cross
8	K _u	12-18	Kurz under
9	K	18-27	Kurz
10	K _a	27-40	Kurz above
11	V	40-75	
12	W	75-110	
13	millimeter	110-300	millimeter

IEEE BANDS

WAVEGUIDES

- Micro- indicates that microwaves are “**small**” compared to waves used in typical radio broadcasting, in that they have shorter wavelengths.
- waveguide may assume any arbitrary but **uniform cross section**, **common waveguides are either rectangular or circular i.e perfect conductor**.
- **Frequency > 300MHz.**

Need for Waveguides

- During the case of **high frequencies**; it seen that there is **loss of electromagnetic waves** in transmission lines. This is mainly because of the factors like **radiation leakage** and **conduction resistance**. To solve this problem waveguides are widely used.
- Waveguides can direct the power where it is required.
- It can at the same time handle large amount of the power.

- The fundamental characteristics of **waveguide** and **transmission line waves** (*modes*) are **quite different**.
- transmission line may operate from dc ($f= 0\text{Hz}$) to a very high frequency.
- a **waveguide** can **operate only above a certain frequency** called the **cutoff frequency** and therefore **acts as a high-pass filter**.

- For a rectangular waveguide, cut off frequency is given by;

$$f_c = \frac{1}{2a\sqrt{\mu\epsilon}} = \frac{c}{2a}$$

Here **f_c** represents the cut off frequency,
a represents the rectangular cross section,
c is the speed of light,
μ represents the permeability and
ε is the permittivity

Comparison of Waveguide and Transmission Line Characteristics

Comparison of Waveguide and Transmission Line Characteristics:

Transmission line	Waveguide
Two or more conductors separated by some insulating medium (two-wire, coaxial, <u>microstrip</u> , etc.).	Metal waveguides are typically one enclosed conductor filled with an insulating medium (rectangular, circular) while a dielectric waveguide consists of multiple dielectrics.
Normal operating mode is the TEM or quasi-TEM mode (can support TE and TM modes but these modes are typically undesirable).	Operating modes are TE or TM modes (cannot support a TEM mode).
No cutoff frequency for the TEM mode. Transmission lines can transmit signals from DC up to high frequency.	Must operate the waveguide at a frequency above the respective TE or TM mode cutoff frequency for that mode to propagate.
Significant signal attenuation at high frequencies due to conductor and dielectric losses.	Lower signal attenuation at high frequencies than transmission lines.
Small cross-section transmission lines (like coaxial cables) can only transmit low power levels due to the relatively high fields concentrated at specific locations within the device (field levels are limited by dielectric breakdown).	Metal waveguides can transmit high power levels. The fields of the propagating wave are spread more uniformly over a larger cross-sectional area than the small cross-section transmission line.
Large cross-section transmission lines (like power transmission lines) can transmit high power levels.	Large cross-section (low frequency) waveguides are impractical due to large size and high cost.

Advantages of Microwaves

- Supports larger bandwidth and hence more information is transmitted. For this reason, microwaves are used for point-to-point communications.
- More antenna gain is possible.
- Higher data rates are transmitted as the bandwidth is more.
- Antenna size gets reduced, as the frequencies are higher.
- Low power consumption as the signals are of higher frequencies.
- Effect of fading gets reduced by using line of sight propagation.
- Provides effective reflection area in the radar systems.
- Satellite and terrestrial communications with high capacities are possible.
- Low-cost miniature microwave components can be developed.
- Effective spectrum usage with wide variety of applications in all available frequency ranges of operation.

- Completely shielded; provides good isolation.
- Transmits high powers
- Low loss.
- Waveguides can bend if required in a desired application.

Disadvantages of Microwaves

- Cost of equipment or installation cost is high.
- They are hefty and occupy more space.
- Electromagnetic interference may occur.
- Variations in dielectric properties with temperatures may occur.
- Inherent inefficiency of electric power.
- High cost.
- Large size and mass, particularly at lower frequencies.
- Can't pass DC currents along with your RF signal.

INTRODUCTIO TO ANTENNA

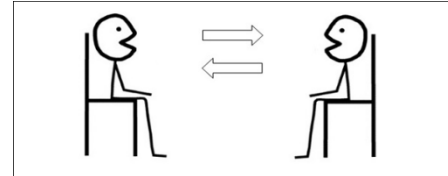

- **voice communication.**
- two individuals communicating with each other. Here, communication takes place through **sound waves.**
- if two people want to communicate who are at longer distances, then we have to convert these sound waves into **electromagnetic waves.**
- The device, which converts the required information signal into electromagnetic waves, is known as an **Antenna.**

ANTENNA BASICS

- An Antenna is a transducer, which converts electrical power into electromagnetic waves and vice versa.
- An Antenna can be used either as a **transmitting antenna** or a **receiving antenna**.



- The power from the transmission line travels through the **waveguide** which has an aperture, to radiate the energy.

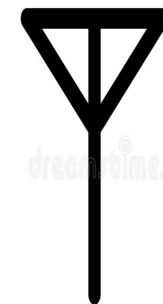
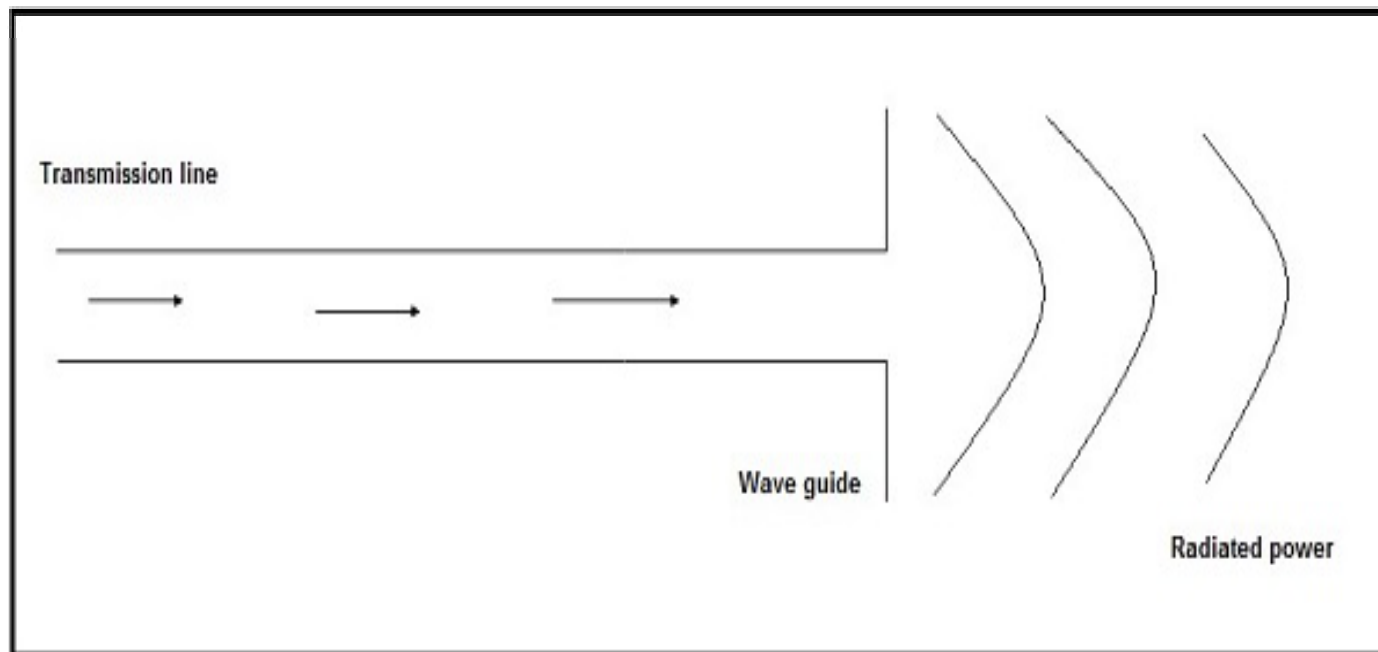

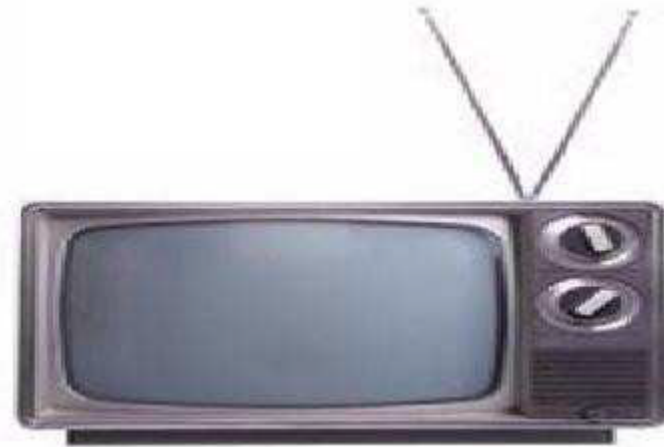

K YOGAPRASAD SITAMS



Basic Types of Antennas

- Depending upon –
 - The physical structure of the antenna.
 - The frequency ranges of operation.
 - The mode of applications etc.
 - Physical structure
- Antennas according to the physical structure.
 - Wire antennas
 - Aperture antennas
 - Reflector antennas
 - Lens antennas
 - Micro strip antennas
 - Array antennas

- Frequency of operation
 - Very Low Frequency (VLF)
 - Low Frequency (LF)
 - Medium Frequency (MF)
 - High Frequency (HF)
 - Very High Frequency (VHF)
 - Ultra High Frequency (UHF)
 - Super High Frequency (SHF)
 - Micro wave
 - Radio wave
- Mode of Applications
 - Point-to-point communications
 - Broadcasting applications
 - Radar communications
 - Satellite communications

Antenna Parameters

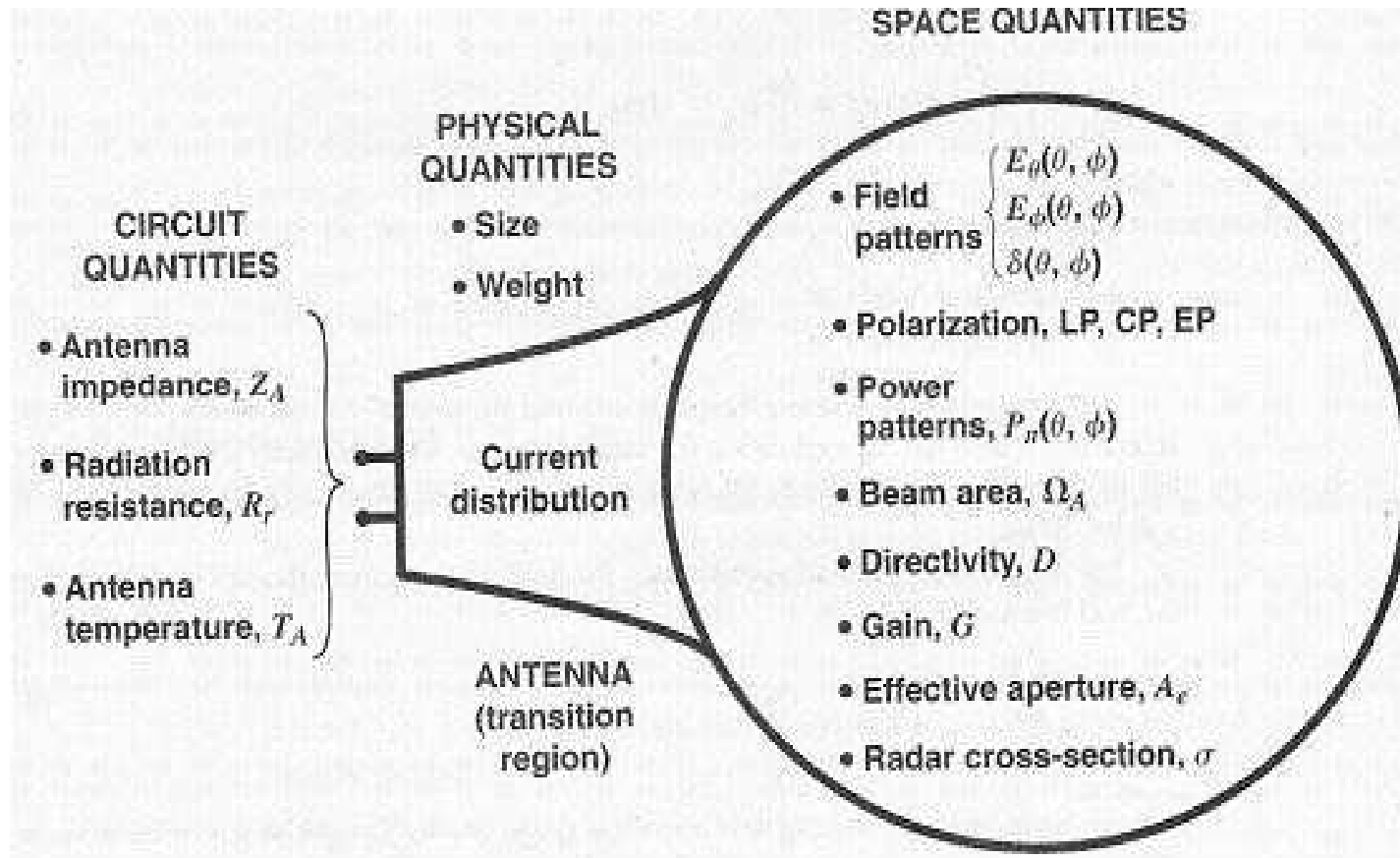

- Frequency
- Wavelength
- Impedance matching
- VSWR & reflected power
- Bandwidth
- Percentage bandwidth
- Radiation intensity
- Radiation Pattern
- Field Regions
- Directivity
- Antenna Efficiency
- Antenna Gain
- Effective Aperture
- Friis Transmission Equation
- Antenna Temperature

- **Frequency** - The rate of repetition of a wave over a particular period of time, is called as **frequency**.
- **Wavelength** - The distance between two consecutive maximum points (crests) or between two consecutive minimum points (troughs) is known as the **wavelength**.
 - The **higher the frequency**, the **lesser** will be the **wavelength** and vice versa.

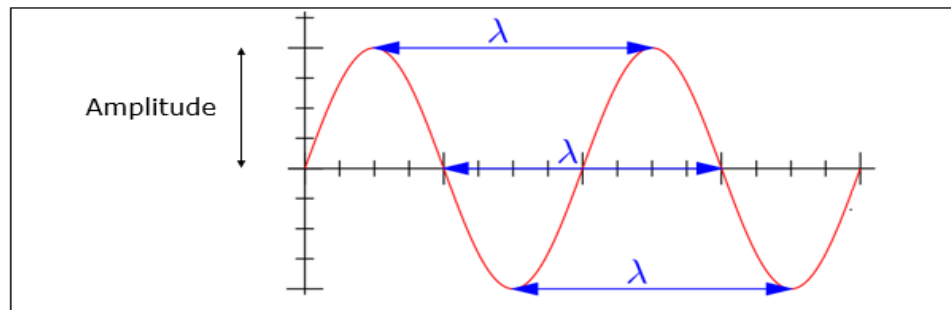

$$\lambda = \frac{c}{f}$$

- **Impedance Matching** - The approximate value of impedance of a transmitter, when equals the approximate value of the impedance of a receiver, or vice versa, it is termed as **Impedance matching**.
- **Necessity of Matching:**
 - The power radiated by an antenna, will be effectively radiated, if the **antenna impedance** matches the free space impedance.
 - For a **receiver antenna**, antenna's output impedance should match with the input impedance of the receiver amplifier circuit.
 - For a **transmitter antenna**, antenna's input impedance should match with transmitter amplifier's output impedance, along with the transmission line impedance.

- **VSWR & Reflected Power** - The ratio of the maximum voltage to the minimum voltage in a standing wave is known as **Voltage Standing Wave Ratio**.

The key features are :

- which indicates the impedance mismatch is **VSWR**.
- The higher the impedance mismatch, the higher will be the value of **VSWR**.
- The ideal value of VSWR should be 1:1 for effective radiation.
- Reflected power is the power wasted out of the forward power. Both reflected power and VSWR indicate the same thing.

- **Bandwidth** - A band of frequencies in a wavelength, specified for the particular communication, is known as **bandwidth**.
 - Bandwidth is the band of frequencies between the higher and lower frequencies over which a signal is transmitted.
 - The bandwidth once allotted, cannot be used by others.
 - The whole spectrum is divided into bandwidths to allot to different transmitters.

- **Percentage Bandwidth** - The ratio of absolute bandwidth to the center frequency of that bandwidth can be termed as **percentage bandwidth**.
 - The particular frequency within a frequency band, at which the signal strength is maximum, is called as **resonant frequency**. It is also called as **center frequency (f_c)** of the band.
 - The higher and lower frequencies are denoted as **f_H and f_L** respectively.
 - The absolute bandwidth is given by- **$f_H - f_L$** .
 - To know how wider the bandwidth is, either **fractional bandwidth** or **percentage bandwidth** has to be calculated.

$$\text{Percentage bandwidth} = \frac{\text{absolute bandwidth}}{\text{center frequency}} = \frac{f_H - f_L}{f_c}$$

- **Radiation Intensity** - the power per unit solid angle.
 - Radiation emitted from an antenna which is more intense in a particular direction, indicates the maximum intensity of that antenna.
 - The emission of radiation to a maximum possible extent is nothing but the radiation intensity.

$$U = r^2 \times W_{rad}$$

- **Radiation Pattern** - the variation of the power radiated by an antenna as a function of the direction away from the antenna.
 - This power variation as a function of the arrival angle is observed in the antenna's far field.
 - An antenna's normalized radiation pattern can be written as a function in spherical coordinates $F(\theta, \phi)$.

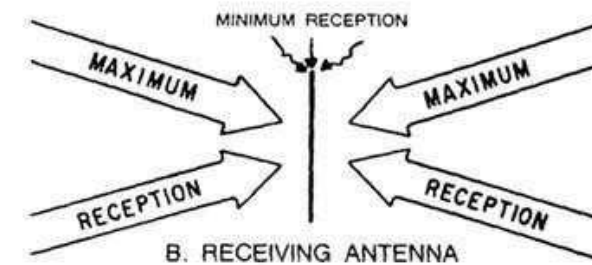
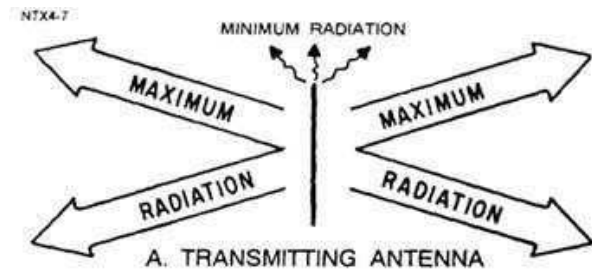
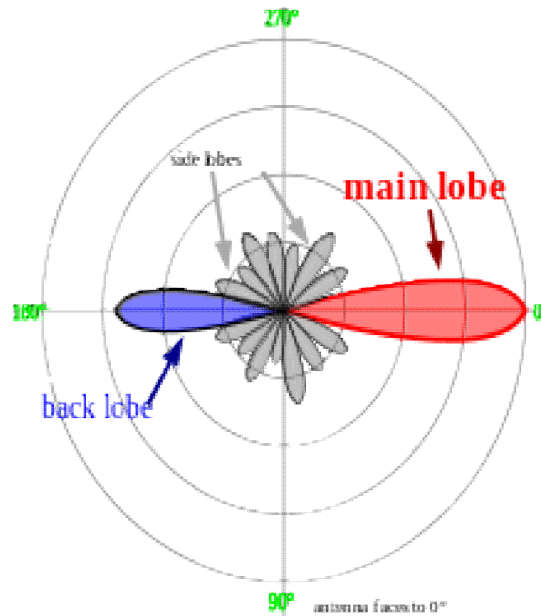
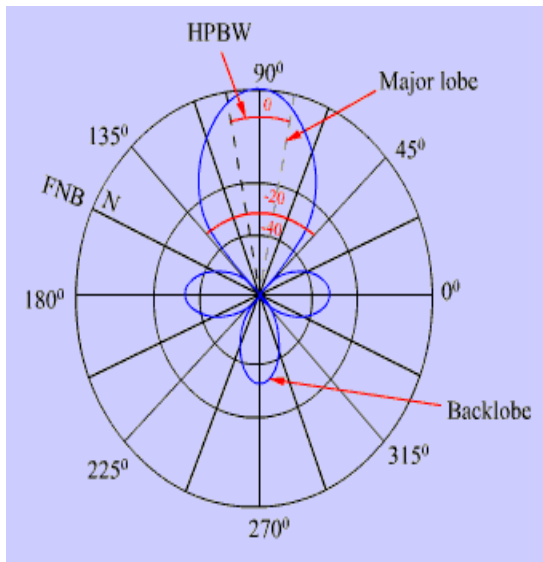

- **Field Regions** - this determines the antenna's radiation pattern.
 - Since antennas are used to communicate wirelessly from long distances, this is the region of operation for most antennas.

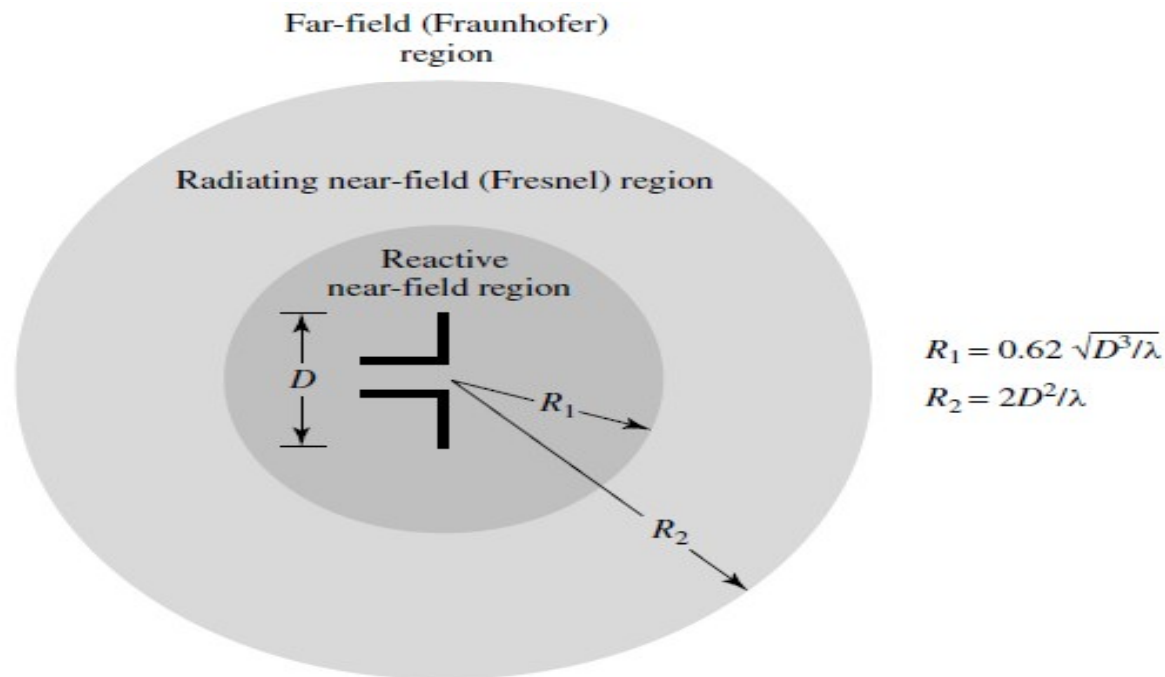

- **Directivity**: fundamental antenna parameter.
- “The ratio of maximum radiation intensity of the subject antenna to the radiation intensity of an isotropic or reference antenna, radiating the same total power is called the **directivity**.”
- It is a measure of how 'directional' an antenna's radiation pattern is. An antenna that radiates equally in all directions would have effectively zero directionality, and the directivity of this type of antenna would be 1 (or 0 dB).

$$\text{Directivity} = \frac{\text{Maximum radiation intensity of subject antenna}}{\text{Radiation intensity of an isotropic antenna}}$$

$$D = \frac{\phi(\theta, \phi)_{\max} (\text{from subject antenna})}{\phi_0 (\text{from an isotropic antenna})}$$

Where

- $(\theta, \phi)_{\max}$ - is the maximum radiation intensity of subject antenna.
- ϕ_0 - is the radiation intensity of an isotropic antenna (antenna with zero losses).

- **Effective Area** or **Effective Aperture**:
- useful parameter calculating the receive power of an antenna.
- Assume that a plane wave with the same polarization as the receive antenna is incident upon the antenna.
- Further assume that the wave is travelling towards the antenna in the antenna's direction of maximum radiation.

- *effective aperture* parameter describes how much power is captured from a given plane wave.
 - Let p be the power density of the plane wave (in W/m^2).
 - If P_t represents the power (in Watts) at the antennas terminals available to the antenna's receiver,
 - $P_t = p A_e$
- the effective area simply represents how much power is captured from the plane wave and delivered by the antenna. This area factors in the losses intrinsic to the antenna (ohmic losses, dielectric losses, etc.).
- A general relation for the effective aperture in terms of the peak **antenna gain** (**G**) of any antenna is given by:

$$A_e = \frac{\lambda^2}{4\pi} G$$

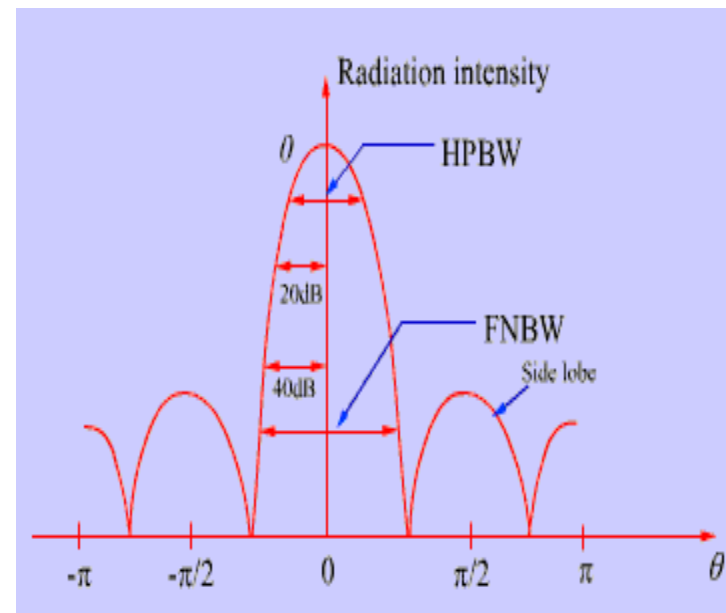

ANTENNA PARAMETERS

- **Aperture Efficiency:**
 - the ratio of the effective radiating area (or effective area) to the physical area of the aperture.”
- An antenna has an aperture through which the power is radiated.
- This radiation should be effective with minimum losses.
- The physical area of the aperture should also be taken into consideration, as the effectiveness of the radiation depends upon the area of the aperture, physically on the antenna.

- where
 - ϵ_A is Aperture Efficiency.
 - A_{eff} is effective area.
 - A_p is physical area.
- **Antenna Efficiency:**
 - “the ratio of the radiated power of the antenna to the input power accepted by the antenna.”
- Simply, an Antenna is meant to radiate power given at its input, with minimum losses.
- The efficiency of an antenna explains how much an antenna is able to deliver its output effectively with minimum losses in the transmission line.
- This is otherwise called as **Radiation Efficiency Factor** of the antenna.

$$\epsilon_A = \frac{A_{eff}}{A_p}$$

- Where

- η_e is the antenna efficiency.

$$\eta_e = \frac{P_{rad}}{P_{input}}$$

- P_{rad} is the power radiated.

- P_{input} is the input power for the antenna.

- **Antenna Gain:**

- a measure of power radiated in a particular direction (typically the peak direction of radiation).
- ratio of the radiation intensity in a given direction to the radiation intensity that would be obtained if the power accepted by the antenna were radiated isotropically.”

- Simply, gain of an antenna takes the directivity of antenna into account along with its effective performance. If the power accepted by the antenna was radiated isotropically (that means in all directions), then the radiation intensity we get can be taken as a referential.

$$G = \eta_e D$$

- The term **antenna gain** describes how much power is transmitted in the direction of peak radiation to that of an isotropic source & measured in **dB**.
- Unlike directivity, antenna gain takes the losses that occur also into account and hence focuses on the efficiency.

- **Beam width and Side lobe:**
 - The **main beam** is the region around the direction of maximum radiation (usually the region that is within 3 dB of the peak of the main beam). The main beam in Figure 2 is centered at 90 degrees.
 - The **sidelobes** are smaller beams that are away from the main beam. These sidelobes are usually radiation in undesired directions which can never be completely eliminated. The sidelobes in Figure 2 occur at roughly 45 and 135 degrees.
 - The **Half Power Beamwidth (HPBW)** is the angular separation in which the magnitude of the radiation pattern decrease by 50% (or -3 dB) from the peak of the main beam.

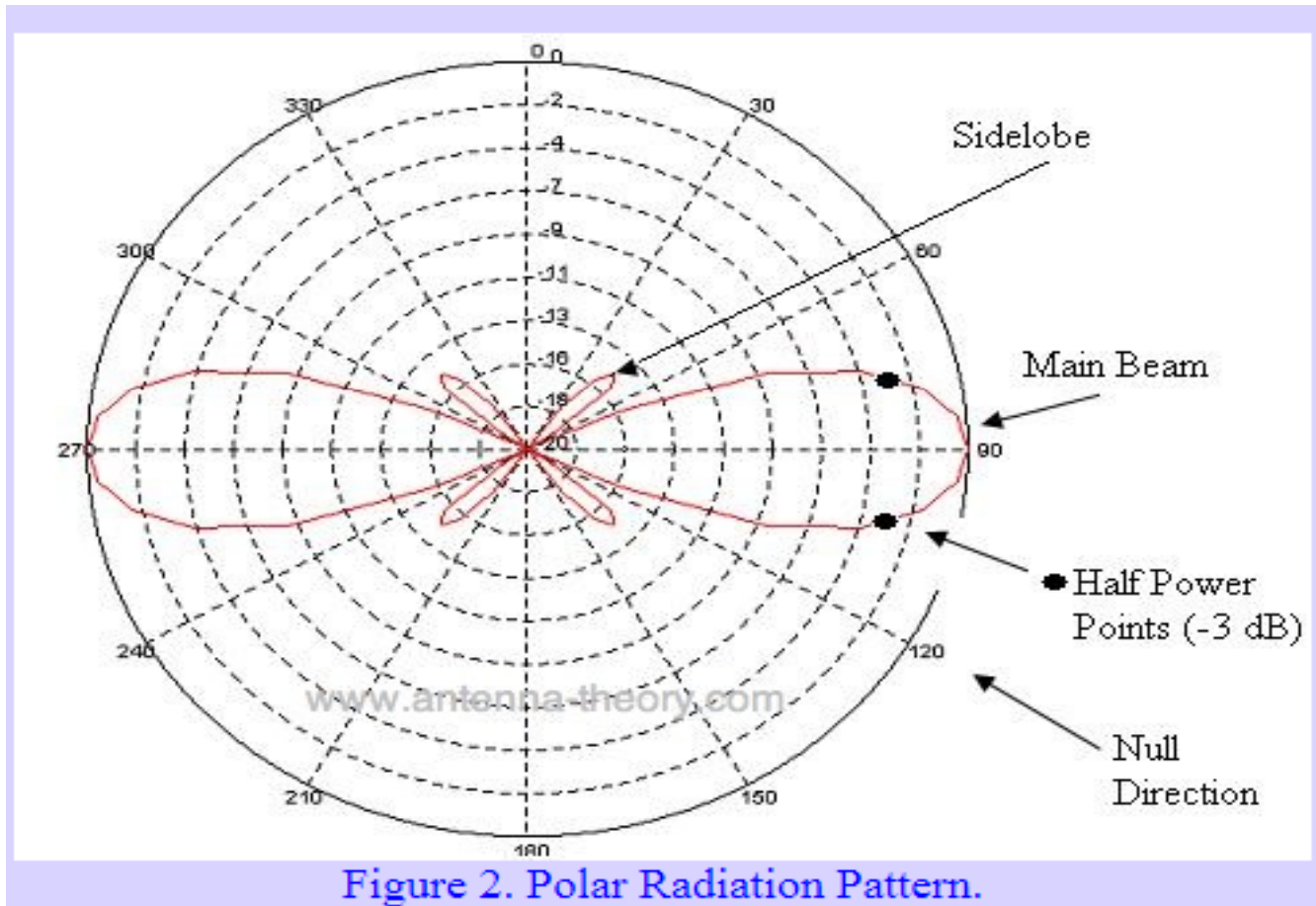

Field Regions

- The fields surrounding an antenna are divided into 3 primary regions:
 - Reactive Near Field
 - Radiating Near Field or Fresnel Region
 - Far Field or Fraunhofer Region
- The far field region is the most important, as this determines the antenna's radiation pattern.
- Since antennas are used to communicate wirelessly from long distances, this is the region of operation for most antennas.

- It is also called as **radiation field**, as the radiation effect is high in this area. Many of the antenna parameters along with the antenna directivity and the radiation pattern of the antenna are considered in this region only.

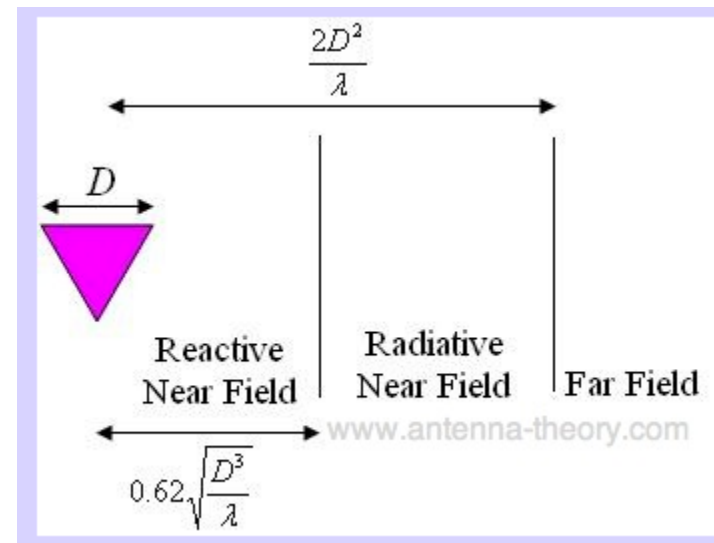
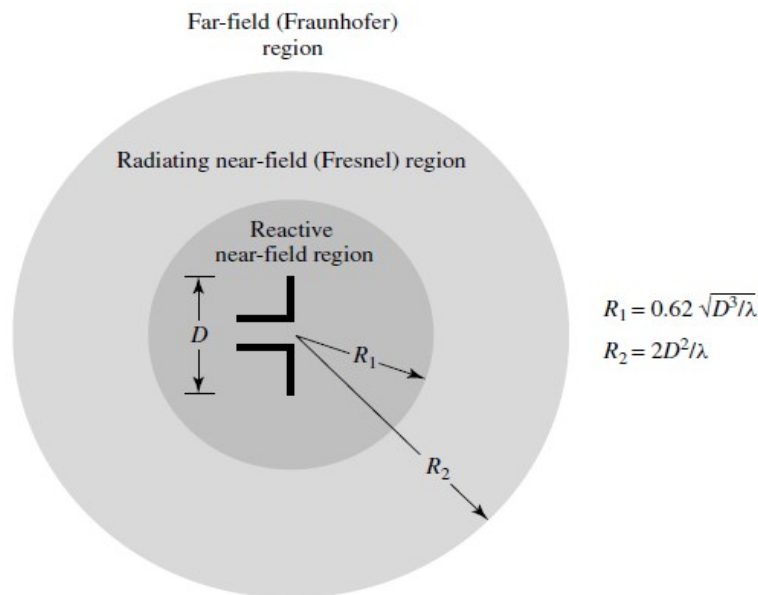

Far Field (Fraunhofer) Region

- the region far from the antenna, as you might suspect. In this region, the radiation pattern does not change shape with distance (R).
- Although the E- and H- fields still die off as $1/R$, the power density dies off as $1/R^2$.
- The far field is dominated by radiated fields, with the E- and H-fields orthogonal to each other and the direction of propagation, as with plane waves.

- If the maximum linear dimension of an antenna is D and the wavelength is λ , then the following 3 conditions must all be satisfied to be in the far field region:

$$R > \frac{2D^2}{\lambda}$$
$$R \gg D$$
$$R \gg \lambda$$

Reactive Near Field Region

- In this region, the fields are predominately reactive fields, which means the E- and H- fields are out of phase by 90 degrees to each other (recall that for propagating or radiating fields, the fields are orthogonal (perpendicular) but are in phase).

$$R < 0.62 \sqrt{\frac{D^3}{\lambda}}$$

Radiating Near Field (Fresnel) Region

- The radiating near field or Fresnel region is the region between the near and far fields.
- In this region, the reactive fields are not dominate; the radiating fields begin to emerge.
- However, unlike the Far Field region, here the shape of the radiation pattern may vary appreciably with distance.

$$0.62\sqrt{\frac{D^3}{\lambda}} < R < \frac{2D^2}{\lambda}$$

Field Pattern

- The field distribution can be quantifying in terms of field intensity is referred to as field pattern.
- That means, the radiated power from the antenna when plotted, is expressed in terms of electric field, E (v/m).
- Hence, it is known as **field pattern**.
- If it is quantified in terms of power (W), then it is known as **power pattern**.

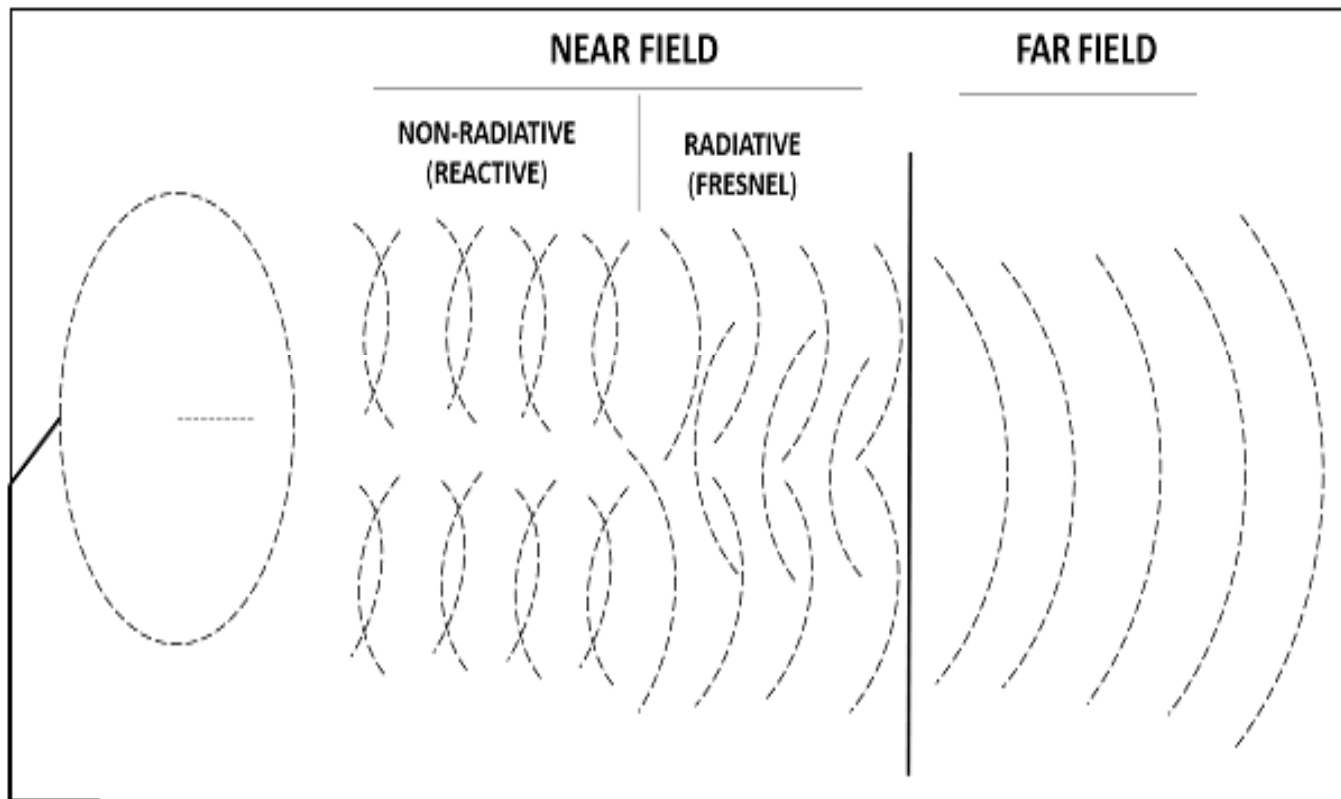

Radiation Pattern

- Radiation is the term used to represent the emission or reception of wave front at the antenna, specifying its strength.
- The sketch drawn to represent the radiation of an antenna is its **radiation pattern**.
- One can simply understand the function and directivity of an antenna by having a look at its radiation pattern.
- The power when radiated from the antenna has its effect in the near and far field regions.
 - Graphically, radiation can be plotted as a function of **angular position** and **radial distance** from the antenna.
 - This is a mathematical function of radiation properties of the antenna represented as a function of spherical co-ordinates, $E(\theta, \phi)$ and $H(\theta, \phi)$.

- The radiation patterns can be field patterns or power patterns.
 - The **field patterns** are plotted as a function of electric and magnetic fields. They are plotted on logarithmic scale.
 - The **power patterns** are plotted as a function of square of the magnitude of electric and magnetic fields. They are plotted on logarithmic or commonly on dB scale.

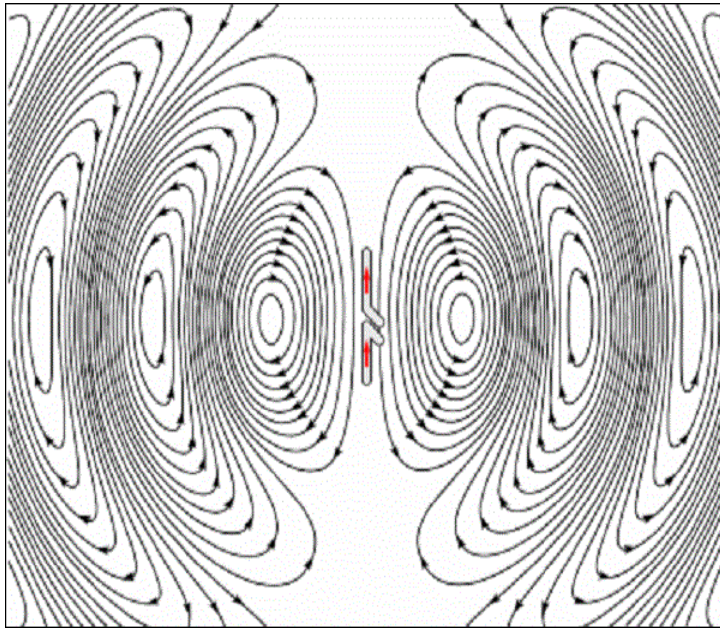

RP of DIPOLE ANTENNA

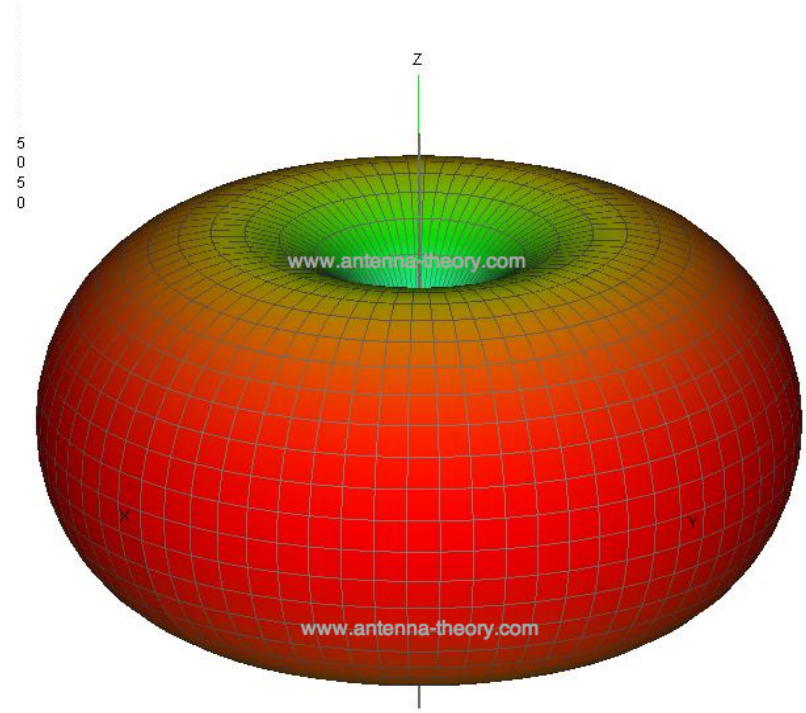

3-D RP

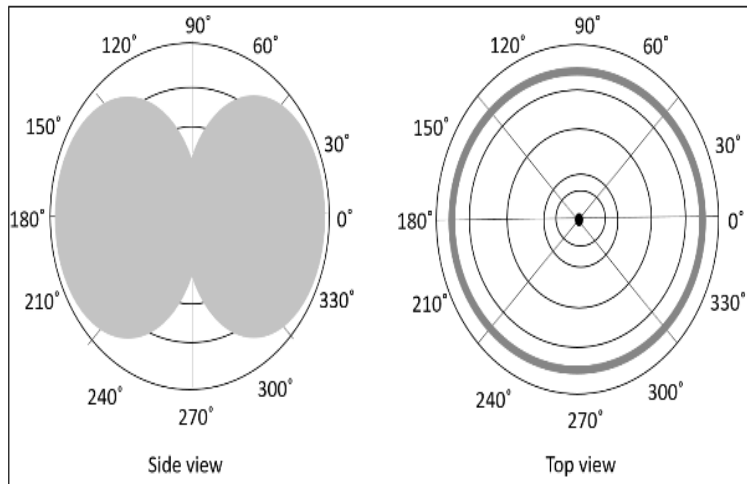

2-D RP

Types of Radiation patterns

- The common types of Radiation patterns are –
 - **Omni-directional pattern** (also called non-directional pattern): The pattern usually has a doughnut shape in three-dimensional view. However, in two-dimensional view, it forms a figure-of-eight pattern.
 - **Pencil-beam pattern** – The beam has a sharp directional pencil shaped pattern.
 - **Fan-beam pattern** – The beam has a fan-shaped pattern.
 - **Shaped beam pattern** – The beam, which is non-uniform and patternless is known as shaped beam.
- A referential point for all these types of radiation is the isotropic radiation.
- It is important to consider the isotropic radiation even though it is impractical.

Isotropic Radiation

- The radiation from a point source, radiating uniformly in all directions, with same intensity regardless of the direction of measurement.
- The improvement of radiation pattern of an antenna is always assessed using the isotropic radiation of that antenna.
- If the radiation is equal in all directions, then it is known as **isotropic radiation**.
- The point source is an example of isotropic radiator.
- However, this isotropic radiation is practically impossible, because every antenna radiates its energy with some directivity.
- The isotropic radiation is nothing but **Omni-directional radiation**.

Effective Radiated Power

- If the radiated power is calculated by taking half-wave dipole as the reference, rather than an isotropic antenna, then it can be termed as **ERP (Effective Radiated Power)**.
 - $ERP(dBW) = EIRP(dBW) - 2.15dBi$

Beam Area

- “Beam area (Ω_A) is the solid angle through which all the power radiated by the antenna would stream if $P(\theta, \phi)$ maintained its maximum value over Ω_A and was zero elsewhere.”
- The radiated beam of the antenna comes out from an angle at the antenna, known as solid angle, where the power radiation intensity is maximum.
- This **solid beam angle** is termed as the **beam area**. It is represented by Ω_A .
- The radiation intensity $P(\theta, \phi)$ should be maintained constant and maximum throughout the solid beam angle Ω_A , its value being zero elsewhere.
 - Power radiated = $P(\theta, \phi) \Omega_A$ watts

$$\Omega_A = \int_0^{2\pi} \int_0^\pi P_\pi(\theta, \Phi) d\Omega \text{ watts}$$

$$d\Omega = \sin \theta d\theta d\Phi \text{ watts}$$

Where

- Ω_A is the solid beam angle.
- P_π is the function of angular position.
- $d\Omega$ is the function of radial distance.

Beam Efficiency

- States that the ratio of the beam area of the main beam to the total beam area radiated."
- The energy when radiated from an antenna, is projected according to the antenna's directivity.
- The direction in which an antenna radiates more power has maximum efficiency, while some of the energy is lost in side lobes.
- The maximum energy radiated by the beam, with minimum losses can be termed as **beam efficiency**.

$$\eta_B = \frac{\Omega_{MB}}{\Omega_A}$$

Where,

- η_B is the beam efficiency.
- Ω_{MB} is beam area of the main beam.
- Ω_A is total solid beam angle (beam area).

Antenna Polarization

- An Antenna can be polarized depending upon our requirement.
- It can be linearly polarized or circularly polarized.
- The type of antenna polarization decides the pattern of the beam and polarization at the reception or transmission.
 - Linear polarization
 - Circular polarization
 - Horizontal polarization
 - Vertical polarization

- **Linear polarization**

- When a wave is transmitted or received, it may be done in different directions. The **linear polarization** of the antenna helps in maintaining the wave in a particular direction, avoiding all the other directions. Though this linear polarization is used, the electric field vector stays in the same plane. Hence, we use this linear polarization to improve the **directivity** of the antenna.

- **Circular polarization**

- When a wave is circularly polarized, the electric field vector appears to be rotated with all its components losing orientation. The mode of rotation may also be different at times. However, by using **circular polarization**, the effect of multi-path gets reduced and hence it is used in satellite communications such as **GPS**.

- **Horizontal polarization**

- Horizontal polarization makes the wave weak, as the reflections from the earth surface affect it. They are usually weak at low frequencies below 1GHz. **Horizontal polarization** is used in the transmission of **TV signals** to achieve a better signal to noise ratio.

- **Vertical polarization**

- The low frequency vertically polarized waves are advantageous for ground wave transmission. These are not affected by the surface reflections like the horizontally polarized ones. Hence, the **vertical polarization** is used for **mobile communications**.

- Each type of polarization has its own advantages and disadvantages.
- A RF system designer is free to select the type of polarization, according to the system requirements.

Beam width

- **Beam width** is the aperture angle from where most of the power is radiated.
- The two main considerations of this beam width:
 - Half Power Beam Width (**HPBW**) and
 - First Null Beam Width (**FNBW**).
- **HPBW** : “The angular separation, in which the magnitude of the radiation pattern decreases by 50% (or -3dB) from the peak of the main beam, is the **Half Power Beam Width**.”
- In other words, Beam width is the area where most of the power is radiated, which is the peak power.
- **Half power beam width** is the angle in which relative power is more than 50% of the peak power, in the effective radiated field of the antenna.

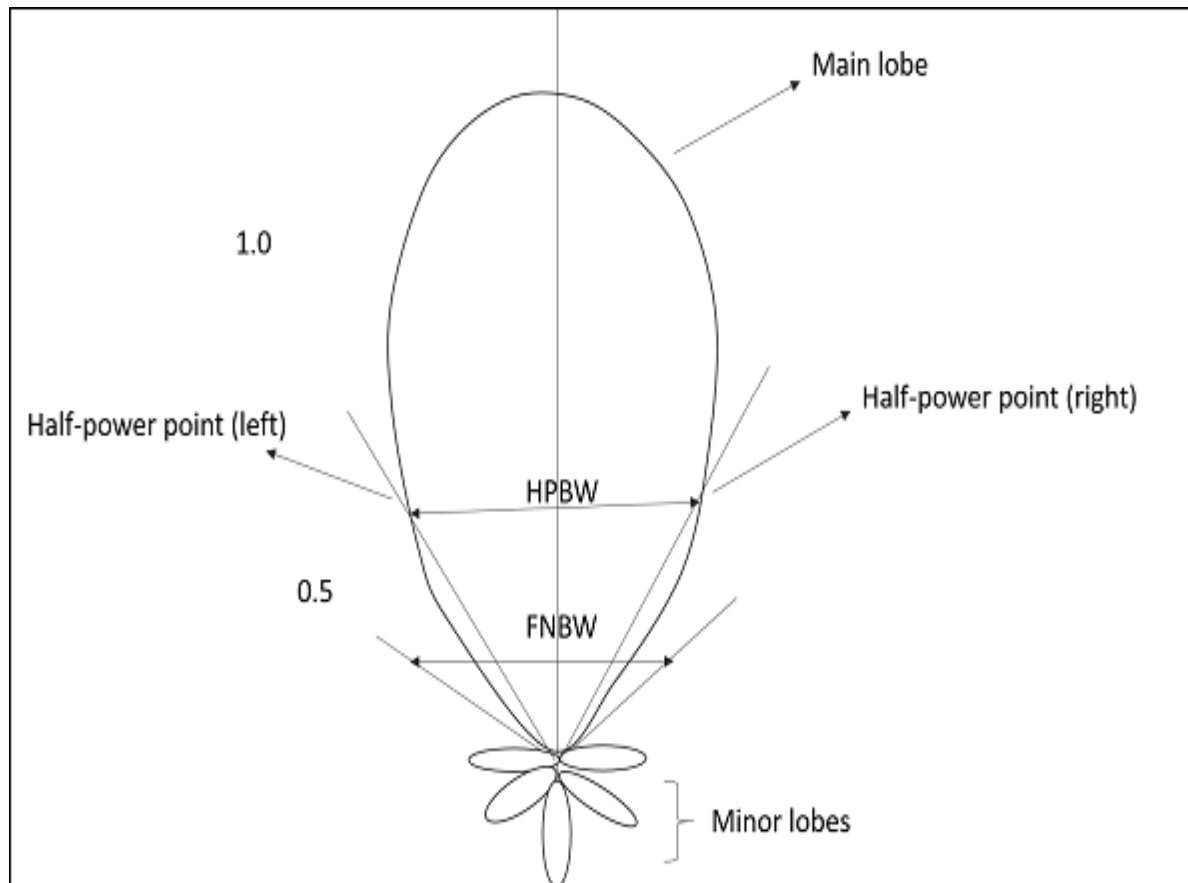

- Where
 - λ is wavelength ($\lambda = 0.3/\text{frequency}$).
 - **D** is Diameter. *Half power Beam with $= 70\lambda/D$*
- The units - **radians** or **degrees**.
- **FNBW:** "The angular span between the first pattern nulls adjacent to the main lobe, is called as the **First Null Beam Width**."
- Simply, FNBW is the angular separation, quoted away from the main beam, which is drawn between the null points of radiation pattern, on its major lobe.

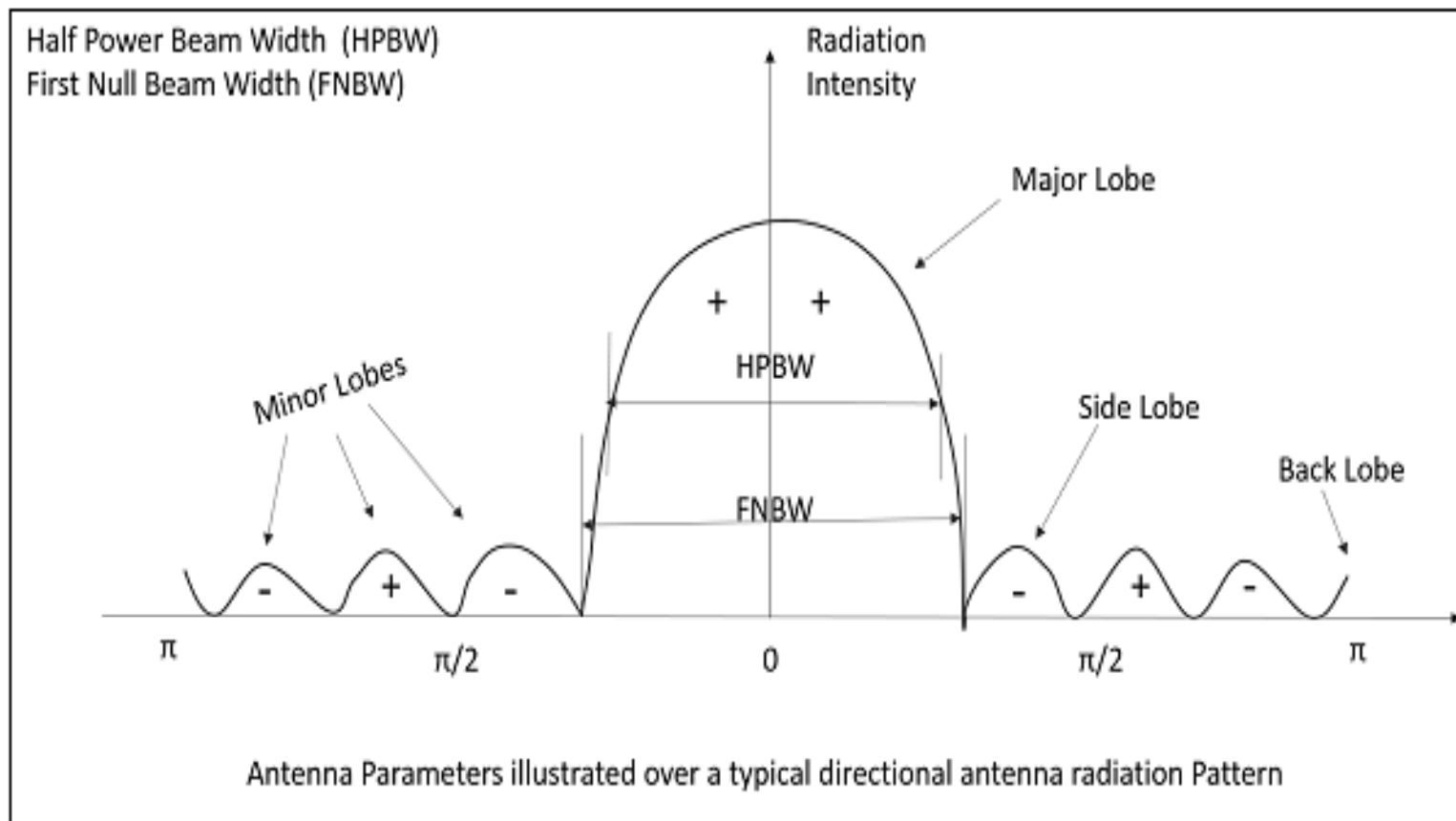

$$FNBW = 2HPBW$$

$$FNBW 2 (70\lambda/D) = 140\lambda/D$$

Effective Length & Effective Area

- Among the antenna parameters, the effective length and effective area are also important.
- **Effective length** : Antenna Effective length is used to determine the polarization efficiency of the antenna.
- **Definition**– “The **Effective length** is the ratio of the magnitude of voltage at the open terminals of the receiving antenna to the magnitude of the field strength of the incident wave front, in the same direction of antenna polarization.”
- When an incident wave arrives at the antenna’s input terminals, this wave has some field strength, whose magnitude depends upon the antenna’s polarization.
- This polarization should match with the magnitude of the voltage at receiver terminals.

$$l_e = \frac{V_{oc}}{E_i}$$

- Where
 - l_e is the effective length.
 - V_{oc} is open-circuit voltage.
 - E_i is the field strength of the incident wave.

Effective area (A_{eff})

- **Definition** – “**Effective area** is the area of the receiving antenna, which absorbs most of the power from the incoming wave front, to the total area of the antenna, which is exposed to the wave front.”
- The whole area of an antenna while receiving, confronts the incoming electromagnetic waves, whereas only some portion of the antenna, receives the signal, known as the **effective area**.
- Only some portion of the received wave front is utilized because some portion of the wave gets scattered while some gets dissipated as heat.
- Hence, without considering the losses, the area, which utilizes the maximum power obtained to the actual area, can be termed as **effective area**.

Reciprocity

- one of the most useful (and fortunate) property of antennas.
- Reciprocity states that the receive and transmit properties of an antenna are identical.
- Hence, antennas do not have distinct transmit and receive radiation patterns.
- If you know the radiation pattern in the transmit mode then you also know the pattern in the receive mode.
- This makes things much simpler, as you can imagine.

Properties under Reciprocity

- The properties of transmitting and receiving antenna that exhibit the reciprocity are:
 - Equality of Directional patterns.
 - Equality of Directivities.
 - Equality of Effective lengths.
 - Equality of Antenna impedances.

Poynting Vector

- It describes the energy of the EM Wave per unit time per unit area at any given instant of time.
- **John Henry Poynting** first derived this vector in 1884 and hence it was named after him.
- **Definition** – “Poynting vector gives the rate of energy transfer per unit area” or “The energy that a wave carries per unit time per unit area is given by the Poynting vector.”
- Poynting vector is represented by “ \hat{S} ”.

- Where $\hat{S} = \hat{E} \times \hat{H}$ $\hat{S} = \frac{1}{\mu_0}(\hat{E}\hat{H})$
 - \hat{S} is the instantaneous Poynting vector (**W/m²**).
 - \hat{E} is the instantaneous electric field intensity (**V/m**).
 - \hat{H} is the instantaneous magnetic field intensity (**A/m**).
- The important point to be noted here is that the magnitude of $E > H$ within an EM wave.
- However, both of them contribute the same amount of energy.
- \hat{S} is the vector, which has both direction and magnitude.
- The direction of \hat{S} is same as the velocity of the wave.
- Its magnitude depends upon the E and H.

The Friis Equation

- The most fundamental equation of antenna theory.
- This equation relates transmit power, antenna gains, distance and wavelength to received power.
- is used to calculate the power received from one antenna (with gain G_1), when transmitted from another antenna (with gain G_2), separated by a distance R , and operating at frequency f or wavelength.

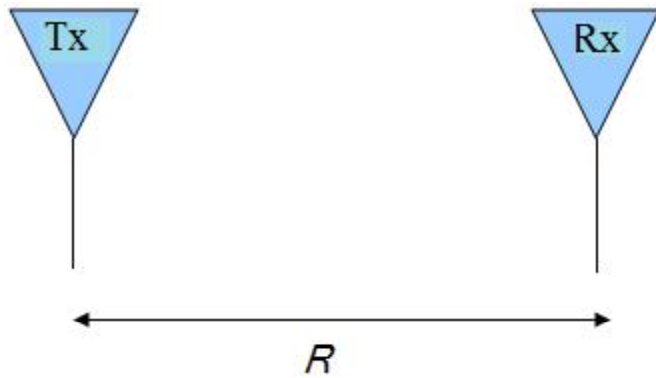

$$P_R = \frac{P_T G_T G_R \lambda^2}{(4\pi R)^2}$$

$$P_R = \frac{P_T G_T G_R c^2}{(4\pi R f)^2}$$

www.antenna-theory.com

FOLDED DIPOLE ANTENNA

- Two conductors connected on both sides, and folded to form a cylindrical closed shape, to which feed is given at the center.
- dipole antenna with the ends folded back around and connected to each other, **forming a loop**.
- The **length of the dipole** is **half of the wavelength**. Hence, it is called as **half wave folded dipole antenna**.
- Frequency range-around 3KHz to 300GHz.
- This is mostly used in **television receivers**.

- Typically, the width d of the folded dipole antenna is much smaller than the length L .
- Because the folded dipole forms a closed loop, one might expect the input impedance to depend on the input impedance of a short-circuited transmission line of length L .
- However, you can imagine the folded dipole antenna as two parallel short-circuited transmission lines of length $L/2$.

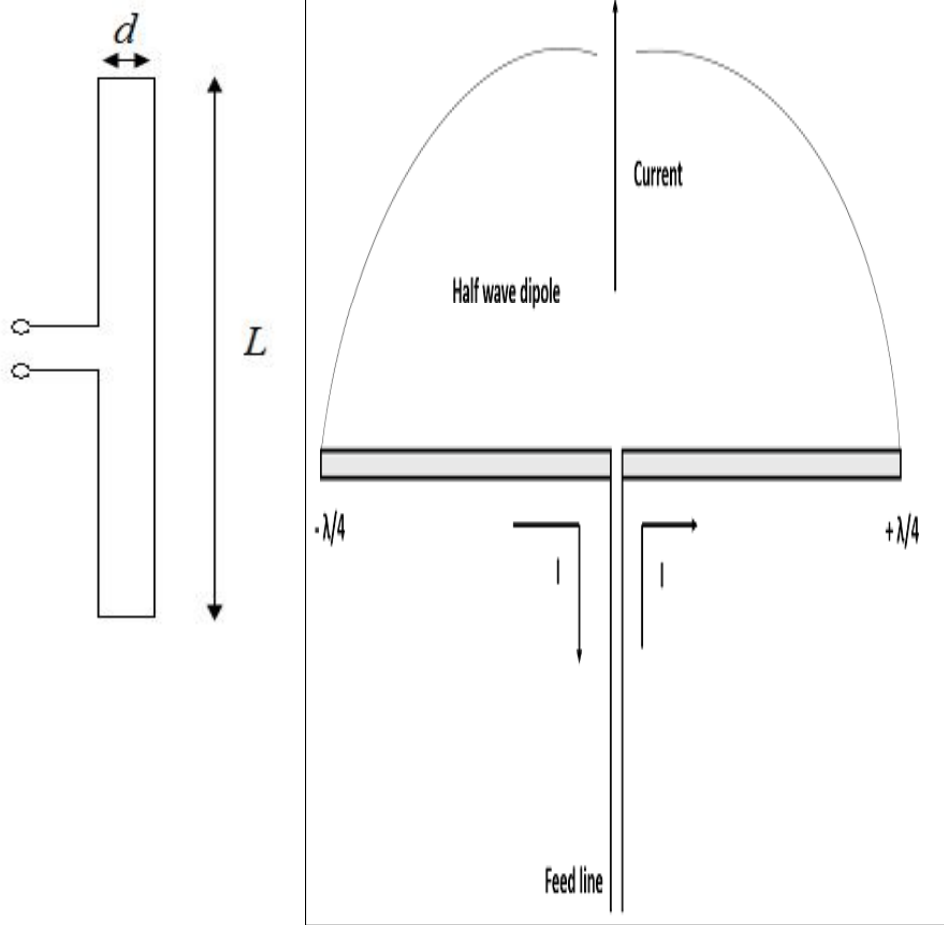

- The input impedance Z_A of the folded dipole is given by:

$$Z_A = \frac{4Z_t Z_d}{Z_t + 2Z_d}$$

- Z_d represent the impedance of a dipole antenna of length L and Z_t represent the impedance of a transmission line impedance of length $L/2$, which is given by:

$$Z_t = jZ_0 \tan \frac{\beta L}{2}$$

Half-Wavelength Folded Dipole

- The antenna impedance for a half-wavelength folded dipole antenna $Z_A = 4 * Z_d$.
- At resonance, the impedance of a half-wave dipole antenna is approximately **70 Ohms**, so that the input impedance for a half-wave folded dipole antenna is roughly **280 Ohms**.
- Because the characteristic impedance of twin-lead transmission lines are roughly **300 Ohms**.

- The radiation pattern of half-wavelength folded dipoles have the same form as that of half-wavelength dipoles.

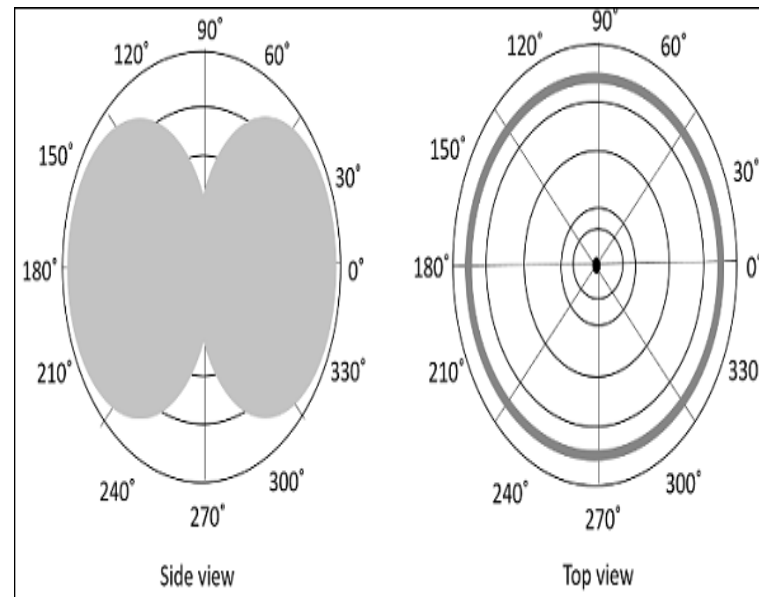
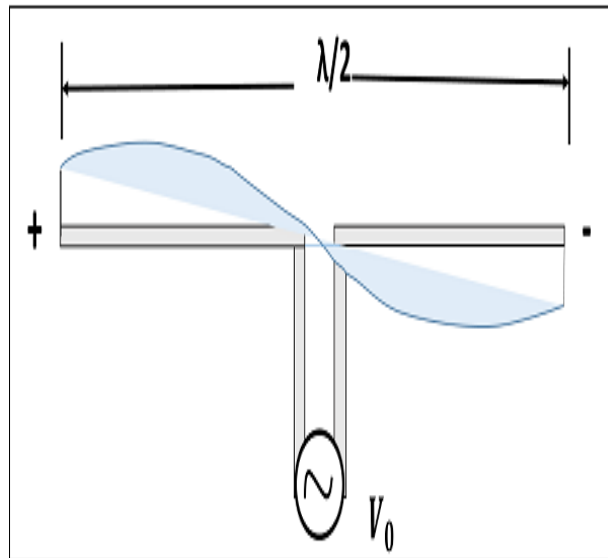

- This folded dipole is the **main element** in **Yagi-Uda antenna**.
- **Advantages**
 - Reception of balanced signals.
 - Receives a particular signal from a band of frequencies without losing the quality.
 - A folded dipole maximizes the signal strength.
- **Disadvantages**
 - Displacement and adjustment of antenna is a hassle.
 - Outdoor management can be difficult when antenna size increases.
- **Applications**
 - Mainly used as a feeder element in Yagi antenna, Parabolic antenna, turnstile antenna, log periodic antenna, phased and reflector arrays, etc.
 - Generally used in radio receivers.
 - Most commonly used in TV receiver antennas.

Yagi-Uda antenna

- Most commonly used type of antenna for **TV reception** over the last few decades.
- It is the most popular and easy-to-use type of antenna with better performance, which is famous for its **high gain** and **directivity**.
- **Frequency range-around 30 MHz to 3GHz** which belong to the **VHF** and **UHF** bands.

- The Yagi antenna was invented in Japan, with results first published in 1926. The work was originally done by Shintaro Uda, but published in Japanese. The work was presented for the first time in English by Yagi.
- It is seen that there are many directors placed to increase the directivity of the antenna.
- The feeder is the folded dipole.
- The reflector is the lengthy element.



Geometry of Yagi Antennas

- The Yagi antenna consists of a single 'feed' or 'driven' element, typically a dipole or a folded dipole antenna. This is the only member of the above structure that is actually excited.
- The rest of the elements are parasitic – they reflect or help to transmit the energy in a particular direction.
- This feed antenna is often altered in size to make it resonant in the presence of the parasitic elements.
(typically, 0.45-0.48 wavelengths long for a dipole antenna).

Geometry of Yagi Antennas

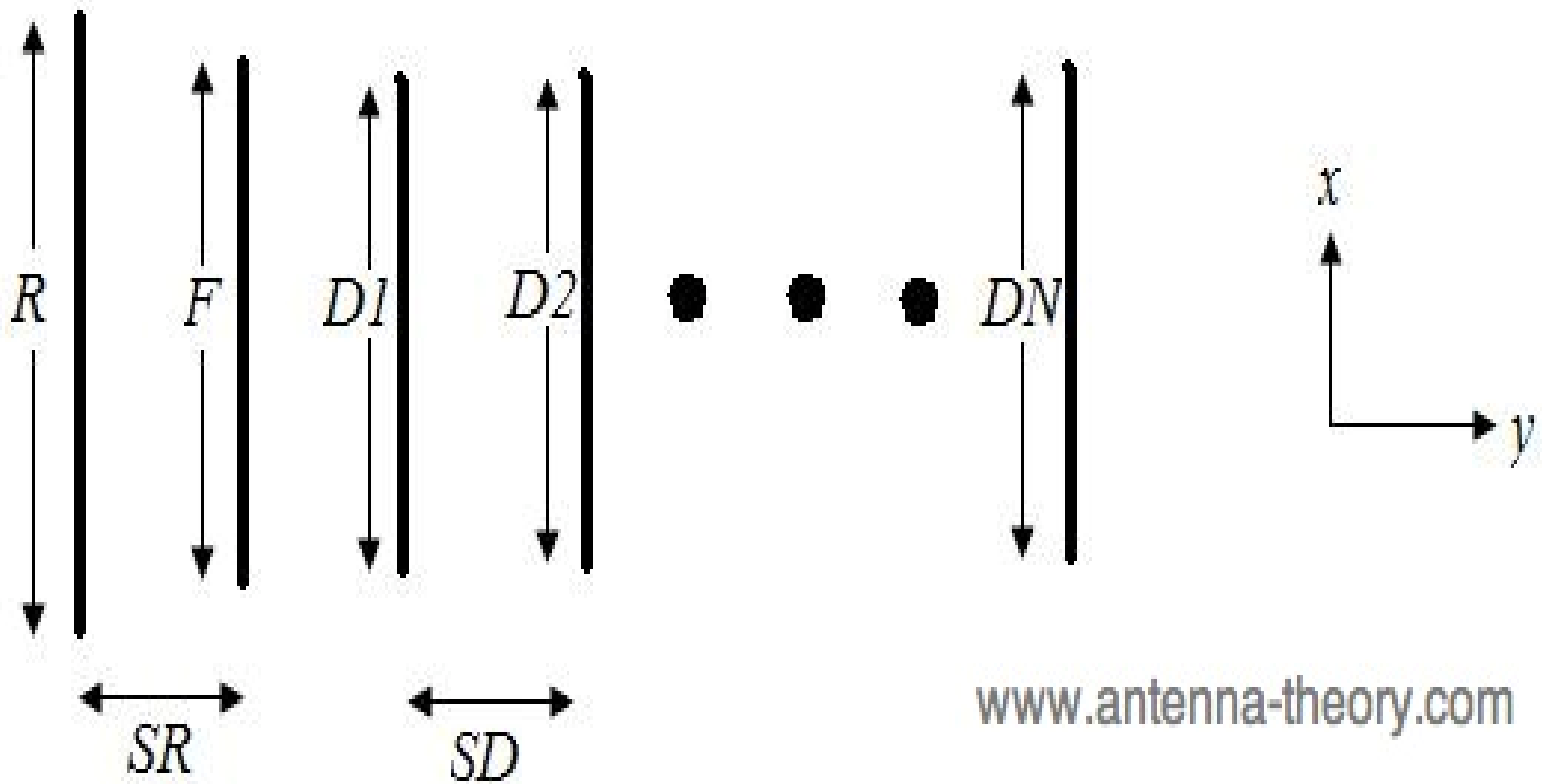

- The element to the left of the feed is the reflector.
- The length of this element is given as R and the distance between the feed and the reflector is SR .
- The reflector element is typically slightly longer than the feed element.
- There is typically only one reflector; adding more reflectors improves performance very slightly.
- This element is important in determining the front-to-back ratio of the antenna.

Design of a Yagi-Uda antenna

- quite simple.
- Because Yagi antennas have been extensively analyzed and experimentally tested.

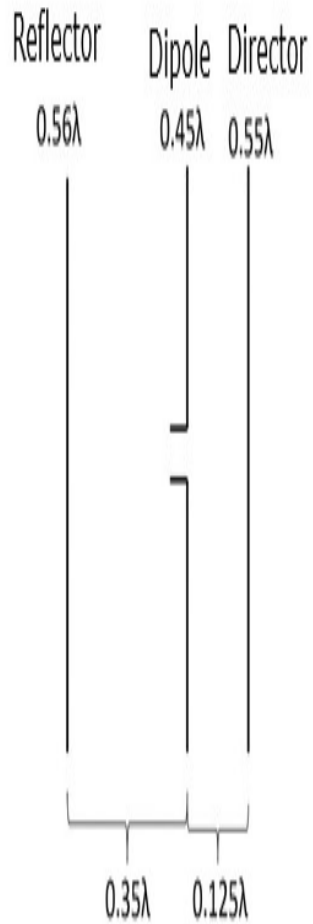

ELEMENT	SPECIFICATION
Length of the Driven Element	0.458λ to 0.5λ
Length of the Reflector	0.55λ to 0.58λ
Length of the Director 1	0.45λ
Length of the Director 2	0.40λ
Length of the Director 3	0.35λ
Spacing between Directors	0.2λ
Reflector to dipole spacing	0.35λ
Dipole to Director spacing	0.125λ

Radiation Pattern

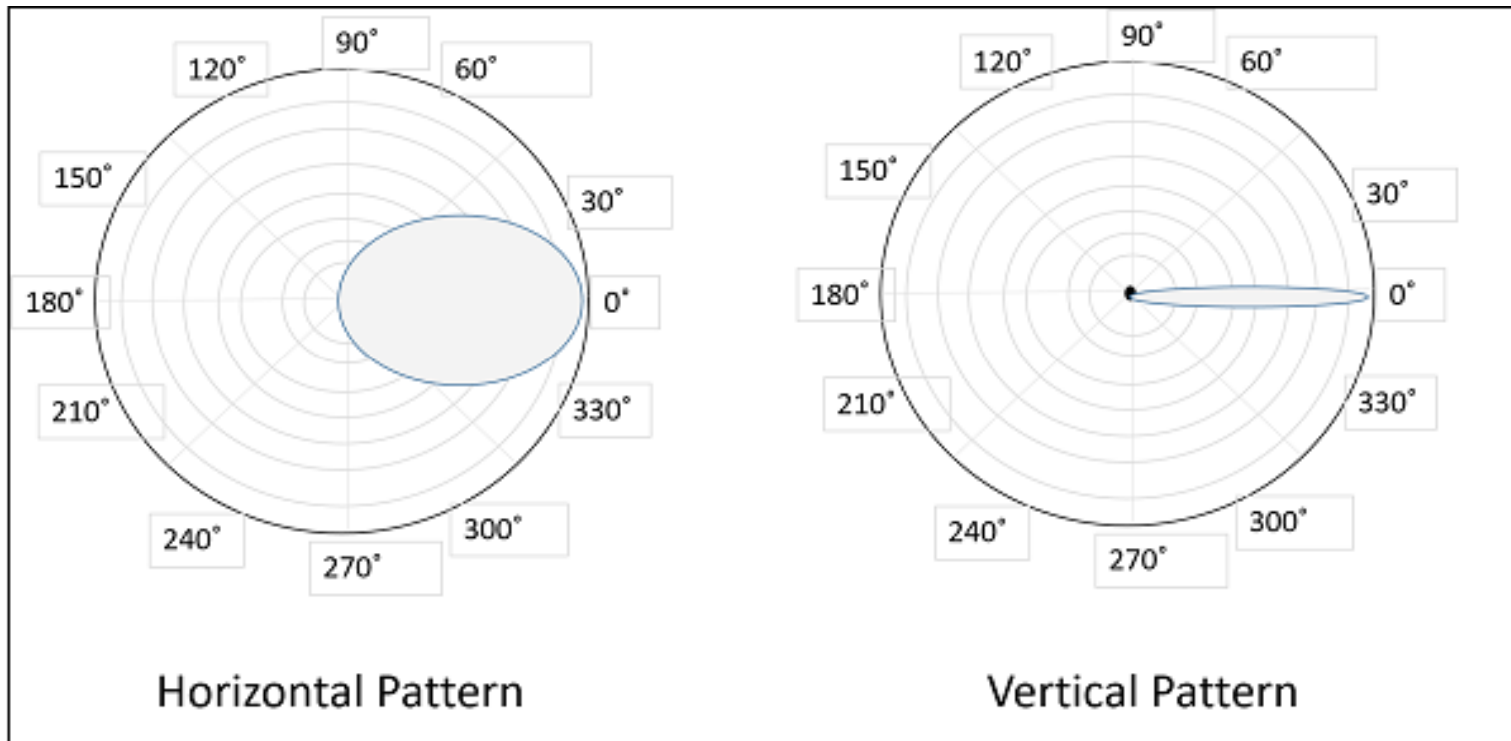

- Advantages

- High gain is achieved.
- High directivity is achieved.
- Ease of handling and maintenance.
- Less amount of power is wasted.
- Broader coverage of frequencies.

- Disadvantages

- Prone to noise.
- Prone to atmospheric effects.

- Applications

- Mostly used for TV reception.
- Used where a single-frequency application is needed.

LOOP ANTENNAS

- Another method of using long wire is by bending and making the wire into a loop shaped pattern and observing its radiational parameters.
- An RF current carrying coil is given a **single turn into a loop**, can be used as an antenna called as **loop antenna**.
- The currents through this loop antenna will be **in phase**.
- The magnetic field will be **perpendicular to the whole loop carrying the current**.
- Frequency Range-
 - around **300MHz to 3GHz**.in **UHF** range.

Construction & Working

- A loop antenna is a coil carrying radio frequency current.
- It may be in any shape such as circular, rectangular, triangular, square or hexagonal according to the designer's convenience.
- Loop antennas are of two types.
 - Large loop antennas
 - Small loop antennas

Large loop antennas

- Large loop antennas are also called as **resonant antennas**.
- They have **high radiation efficiency**.
- These antennas have length nearly equal to the intended wavelength.

$$L=\lambda$$

- Where,
 - **L** is the length of the antenna
 - **λ** is the wavelength
- The main parameter of this antenna is its perimeter length, which is about a wavelength and should be an enclosed loop.

Small Loop Antennas

- The small loop antenna is a **closed loop**.
- have low radiation resistance and high reactance.
- Their impedance is difficult to match to a transmitter.
- As a result, these antennas are most often **used as receive antennas**.
- also called as **magnetic loop antennas**.

The radius is a , and is assumed to be much smaller than a wavelength ($a \ll \lambda$). The loop lies in the x-y plane.

Since the loop is electrically small, the current within the loop can be approximated as being constant along the loop, so that $I = I_0$.

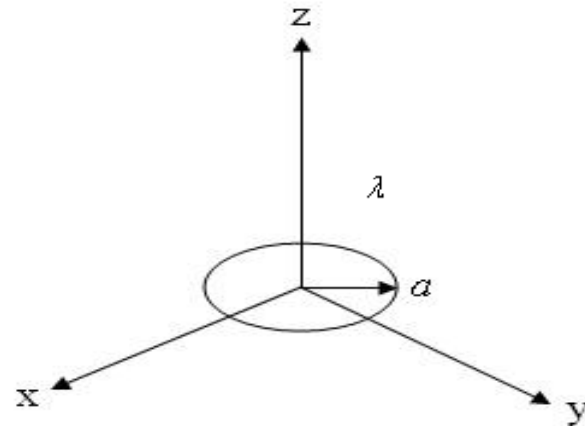

- These antennas are of the size of one-tenth of the wavelength.

$$L=\lambda/10$$

- **Frequently Used Loops**
 - Circular loop antennas
 - Square loop antennas
-

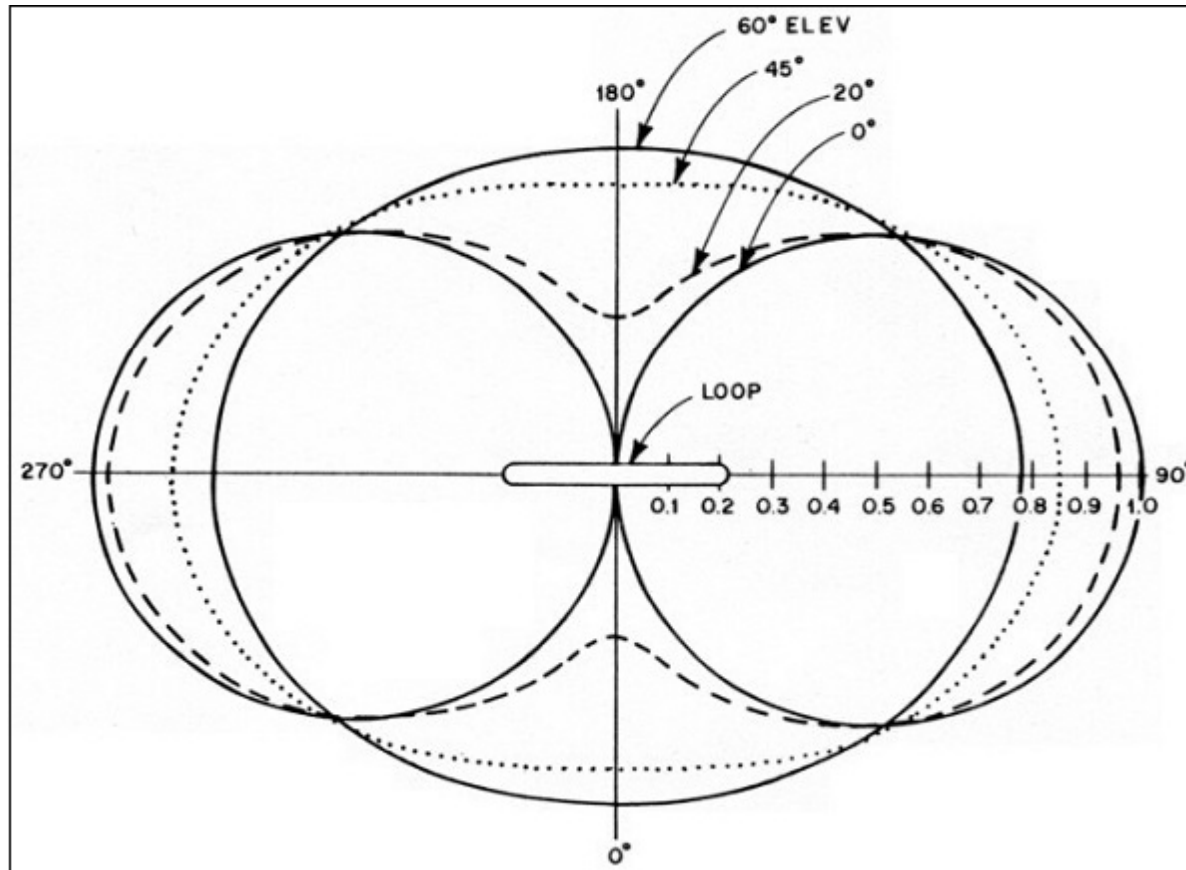

Fig 1: Circular loop antenna



Fig 2: Square loop antenna

Radiation Pattern



- **Advantages**
 - Compact in size
 - High directivity
- **Disadvantages**
 - Impedance matching may not be always good
 - Has very high resonance quality factor
- **Applications**
 - Used in RFID devices
 - Used in MF, HF and Short wave receivers
 - Used in Aircraft receivers for direction finding
 - Used in UHF transmitters

SLOT ANTENNA

- an example of Aperture antenna.
- It works in **UHF** and **SHF** frequency ranges-
300 MHz to 30 GHz..
- Radiation Pattern of the Slot antenna is
Omni-directional
- **Babinet's Principle.**

Babinet's Principle

- Babinet proposed that two complementary screens generate a similar diffraction pattern. This is known as Babinet's principle. According to this principle, the structure of the slot antenna and the half-wave dipole structure cut out from the conducting sheet are complementary to each other.
- states that- "When the field behind a screen with an opening is added to the field of a complementary structure, the sum is equal to the field when there is no screen".

- **Definition:** A type of antenna with an opening cut of certain dimensions in a metallic conductor which is excited using a two-wire transmission line or coaxial cable is known as a slot antenna.
- slot cut of about $\lambda/2$ length and width very less than $\lambda/2$ in a metallic conductive sheet. The excitation to the slot is provided at the centre or off the centre.

- A horizontal slot antenna provides a vertically polarized signal. While a vertical slot antenna gives the horizontally polarized signal.
- Operating principle
 - Slot antennas operate on the principle that whenever a high-frequency field is present across the slot in a metallic sheet, then energy is radiated.
- This is the reason when a slot is cut from the surface of the conductive plate then on energizing the slot, the electromagnetic wave is radiated thus acts as an antenna. Due to the presence of a slot, it is named as a slot antenna.

- a conductive surface with a slot of particular dimensions is referred as a slot antenna.

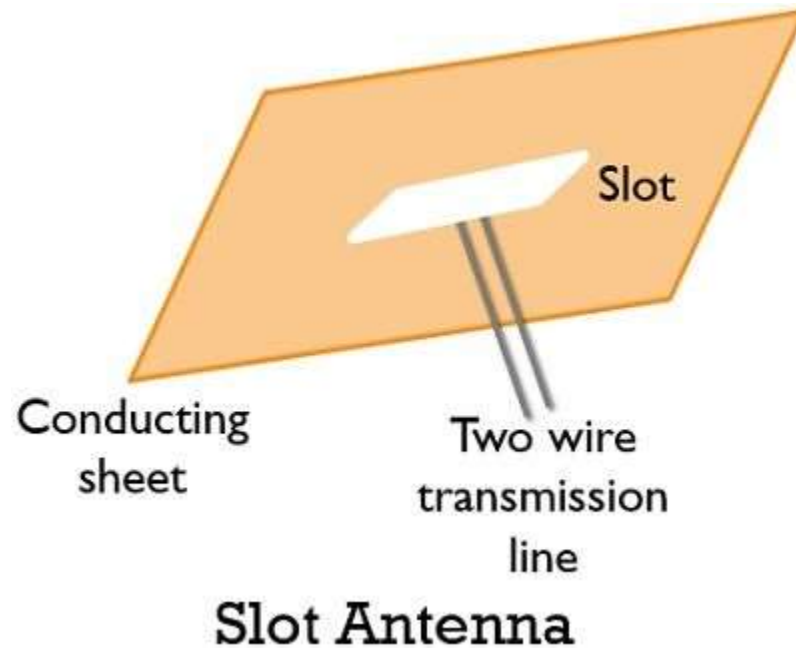

- So, the region which is cut from the conducting sheet is the half-wave dipole that acts as the slot's complementary antenna, known as a complementary dipole antenna.

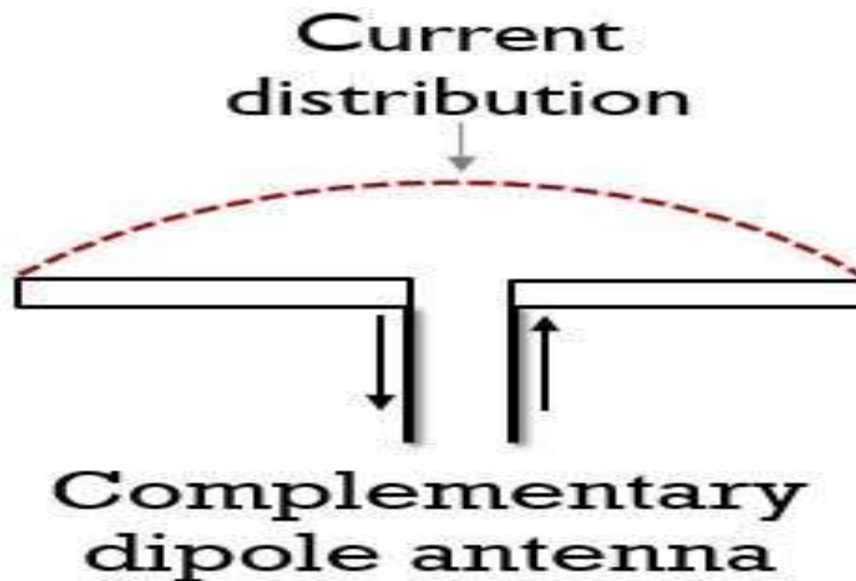



Figure 1

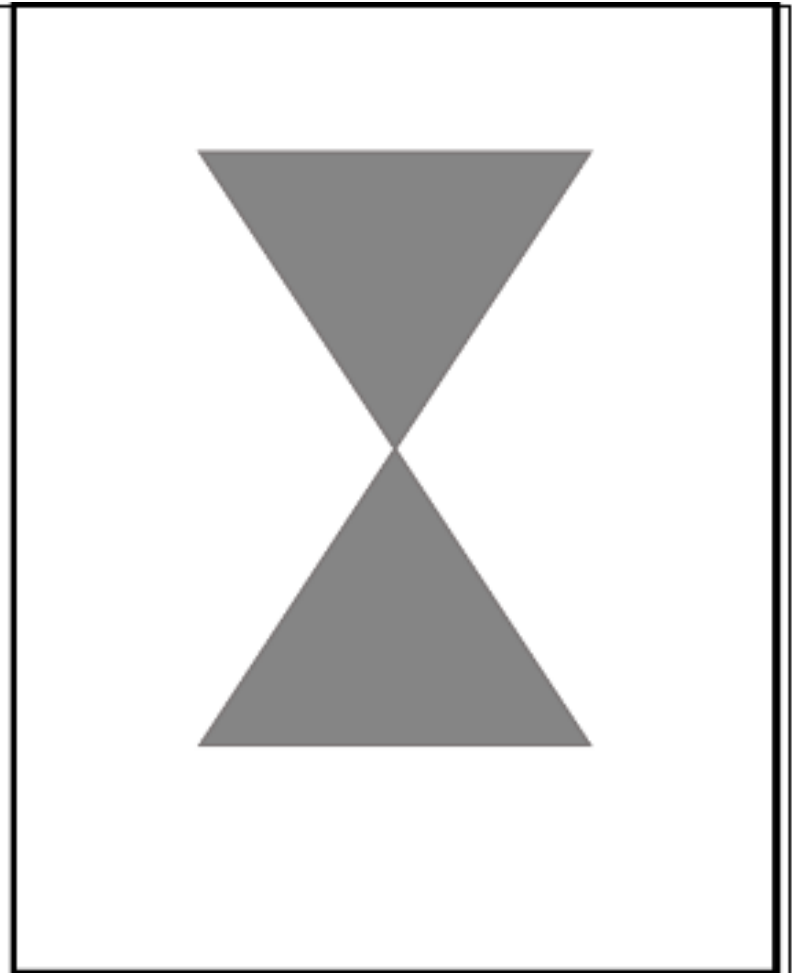

Figure 2

- **Case 1** – Consider a light source and a conducting plane (field) with an aperture before a screen. The light does not pass through the opaque area, but passes through the aperture.
- **Case 2** – Consider the light source and a conducting plane of the size of the aperture in the previous case, being held against the screen. The light does not pass through the plane but through the remaining portion.

Working of Slot Antenna

- This principle of optics is applied to electromagnetic waves for the wave to get radiated. It is true that when a HF field exists across a narrow slot in a conducting plane, the energy is radiated.
- Consider an infinite plane conducting screen is taken and pierced with apertures of desired shape and size and this will be the screen of slot antenna. Another screen is considered interchanging the places of aperture and screen area which is the complementary screen.
- These two screens are said to be **complementary** as they result in complete infinite metal screen. Now, this becomes the slot antenna. The terminal impedance is quite desirable for the radiation.



slot and complementary dipole antenna

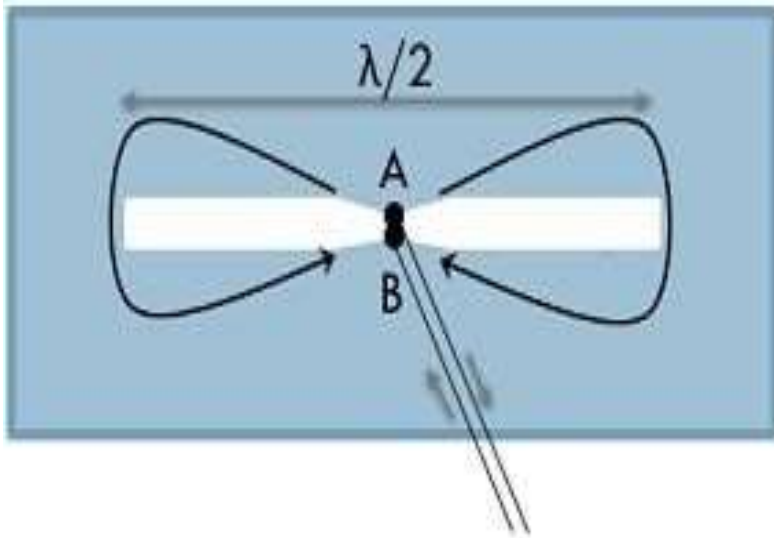

Slot Antenna

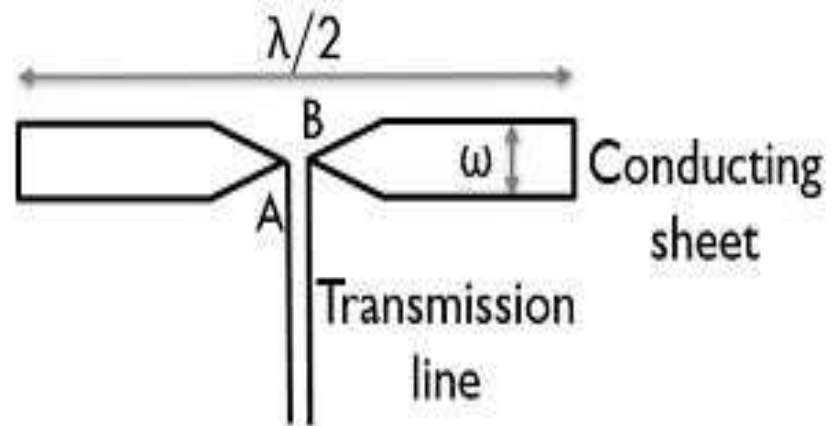

Complementary dipole antenna

Slot Antenna and Complementary Dipole Antenna

Electronics Desk

- Here the external feed which is used as the excitation is provided at the center of the slot using the two-wire transmission line.
- The impedance of the slot antenna relies on the feed point position. As impedance shows reduction with the shift of feed point towards the edge from the centre.
- It is noteworthy here that the radiation pattern of the slot and the dipole are similar to each other. However, the electric field will be vertically polarized for the slot while horizontally polarized for the dipole.

- The radiation pattern of the Slot antenna is **Omni-directional**, just like a half-wave dipole antenna. Take a look at the following illustration. It shows the radiation pattern of Slot antenna drawn in Horizontal and Vertical planes respectively.
- Advantages:
 - It can be fabricated and concealed within metallic objects.
 - It can provide covert communications with a small transmitter.

- Disadvantages
 - Higher cross-polarization levels
 - Lower radiation efficiency
- Applications
 - Usually for radar navigational purposes
 - Used as an array fed by a wave guide

Impedance of the Slot Antenna

The relation between the terminal impedance of slot, Z_s and dipole Z_d is given as:

$$Z_s Z_d = \frac{\eta_0^2}{4}$$

: η_0 denotes the intrinsic impedance of free space.
Since, $\eta_0 = 376.7$

Thus on substituting, we will get

$$Z_s Z_d = \frac{(376.7)^2}{4}$$

$$Z_s Z_d = 35475.7225$$

Hence,

$$Z_s = \frac{35476}{Z_d} \Omega$$

Therefore, we can determine the properties of the complementary slot antenna if the properties of the dipole antenna are known.

For a half-wave dipole antenna

$$\underline{Z_d} = 73 + j(42.5) \Omega$$

Then the terminal impedance of slot antenna will be:

$$Z_s = \frac{35476}{73 + j(42.5)} * \frac{73 - j(42.5)}{73 - j(42.5)}$$

On simplifying, we will have

$$\underline{Z_s} = 363 - j(211) \Omega$$

ANTENNA MEASUREMENTS

- Testing of real antennas is **fundamental to antenna theory**.
- regarded as a **crucial aspect of antenna designing**.
- performed at different levels that lead to help in checking whether the desired specifications have met or not.
- It involves a method where the source antenna (either transmitting or receiving) is placed at various positions in correspondence to the **Antenna Under Test (AUT)**.

- regarded as the **experimental validation of the parameter values given in an antenna datasheet.**
- The test setup uses source antennas or transmitting antennas with known characteristics so that field incidents on the antenna under test are **approximately plane waves.**
- to **reduce the error in measured parameters to acceptable levels.**
- The **antenna measurements ensure that the antenna under test meets all specifications.**
- There are various antenna measurement methods available to characterize antennas.

Parameters commonly measured using antenna

- Radiation pattern
- Polarization
- Input impedance
- Voltage standing wave ratio (VSWR)
- Directivity
- Gain
- Efficiency
- Effective Isotropically Radiated Power (EIRP)
- Antenna noise temperature
 - For any of these antenna parameter measurements, a proper test setup is required. The influence of the test setup is very important, as it can create error measurements.

Antenna Measurement Setup

- utilizes plane waves for testing the antenna under test.
- The test setup uses source antennas or transmitting antennas with known characteristics so that field incidents on the antenna under test are approximately plane waves.
- The antenna measurement setup includes the following systems:

- **Antenna Under Test** - The antenna whose characteristics are to be measured.
- **Source Antenna and Transmitter** -
 - A source antenna with a known radiation pattern and transmitter system is used to send plane waves to the antenna.
 - The source antenna radiates fields that can be approximated to plane waves at the desired frequency.
 - The polarization and beam-width of the source antenna need to be in a range that is suitable for the antenna under test.
 - Horn antennas are an example of a source antenna in the antenna measurement setup.

- **Receiver System** -
 - The receiver system is used to measure the power received by the antenna under test.
 - The receiving system must determine how much power is received from the test.
- **Positioning System** -
 - The positioning system controls the orientation of the antenna under test.
 - The positioning system rotates the antenna under test and helps in measuring the radiation pattern of the test antenna.
 - For determining the radiation pattern as a function of angle, the test antenna is rotated with respect to the source antenna.

Antenna Measurement Methods

- **With a Spectrum Analyzer**
- **With a Vector Network Analyzer**
- **With the Field or Walker Method**
- **In Normal Space**
- **In Anechoic Chambers**
 - Antenna measurements performed in the **anechoic chamber** provide fairly good and accurate measurements when compared to other antenna measurement methods exposed to the reflective environment.

Need for Antenna Measurement

- The analysis that incorporates validation of the actual measurement of the antenna parameters is more beneficial for complex antenna structures.
- some specific antenna designs for which there are fewer chances of desired results through study and analytical investigations, some experimental validations are important.
- Due to this reason, antenna measurement is necessary where a test antenna is taken into consideration and the experiment is carried out.

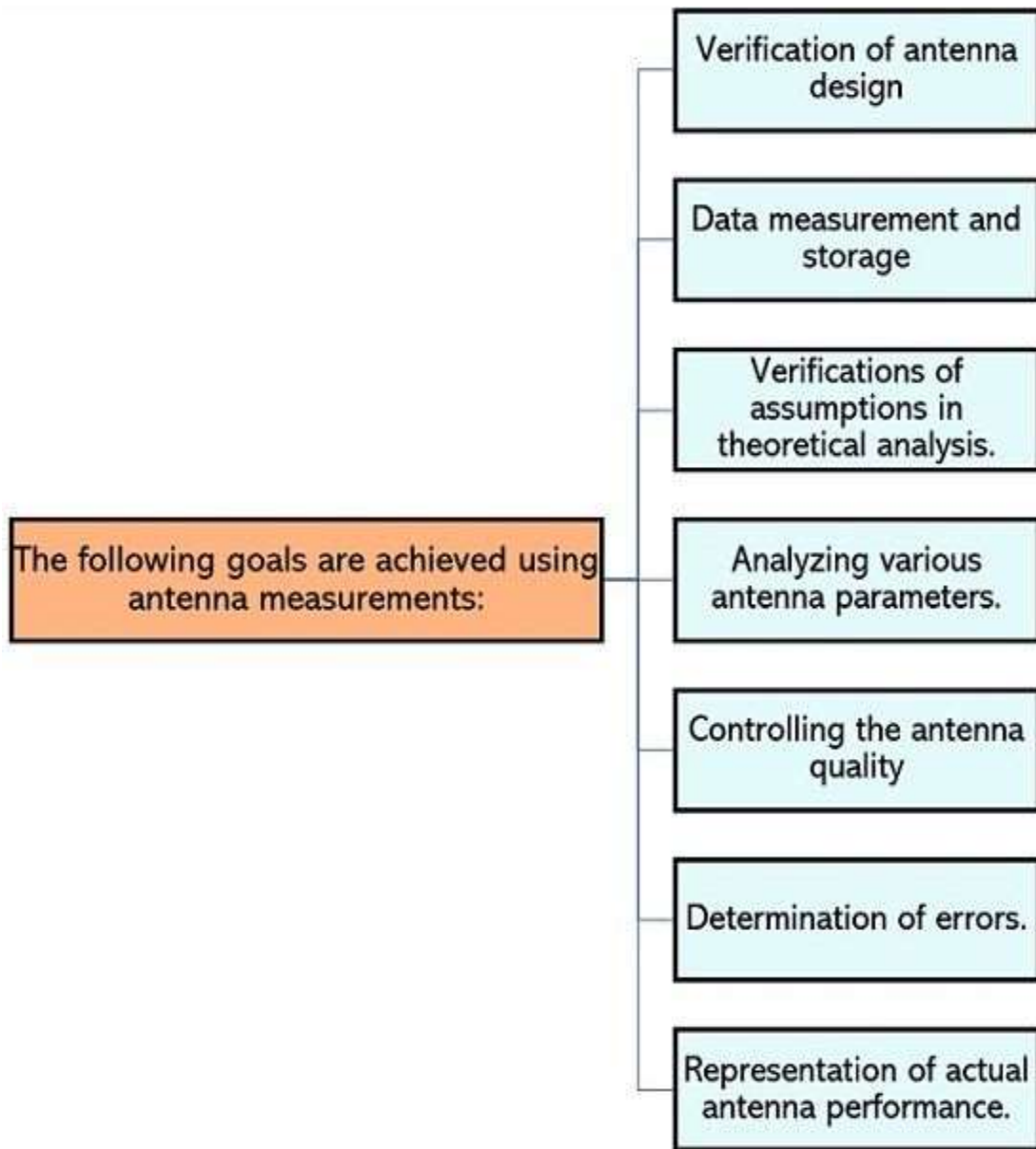

How antenna measurement is done?

- As w k t, the various parameters are recorded from a different location using the source antenna and the antenna under test.
- just by rotating the AUT at its original position various samples can be collected.
- The received pattern will be sharp only in case when there will be a direct path between source antenna and AUT.
- And this can be achieved when the testing environment is free from reflections.
- Thus, to achieve this use of anechoic chamber in free space is used.
- Antenna arrangement follows **Reciprocity Theorem**.

- Experimentally the antenna measurements are classified as:
 - Impedance Measurements
 - Pattern Measurements
- In impedance measurement, the intrinsic, input, self and mutual impedance are measured.
- While in pattern measurements, gain, beam-width, polarization and radiation characteristics are measured.

Antenna Impedance Measurement

- depends on the frequency of operation.
- basis of the frequency range, there are two methods of impedance measurement.
- for low-frequency applications i.e., below 30 MHz, the bridge method is used for measurement.
- for high-frequency range i.e., above 1000 MHz, slotted line measurement is used.
- Also, in the frequency range between 30 to 1000 MHz, any of the methods can be used but that depends on convenience and equipment availability.

Impedance Measurement by Wheatstone Bridge Method

- used to determine the unknown value of impedance by comparing it with known impedance.
- using this method impedance at frequencies up to 30 MHz can be determined.
- consists of 4 impedances in the 4 arms.
- Here the Z_a and Z_b are ratio arms while Z_c corresponds to variable arm impedance and Z_d is the unknown impedance which is to be measured.

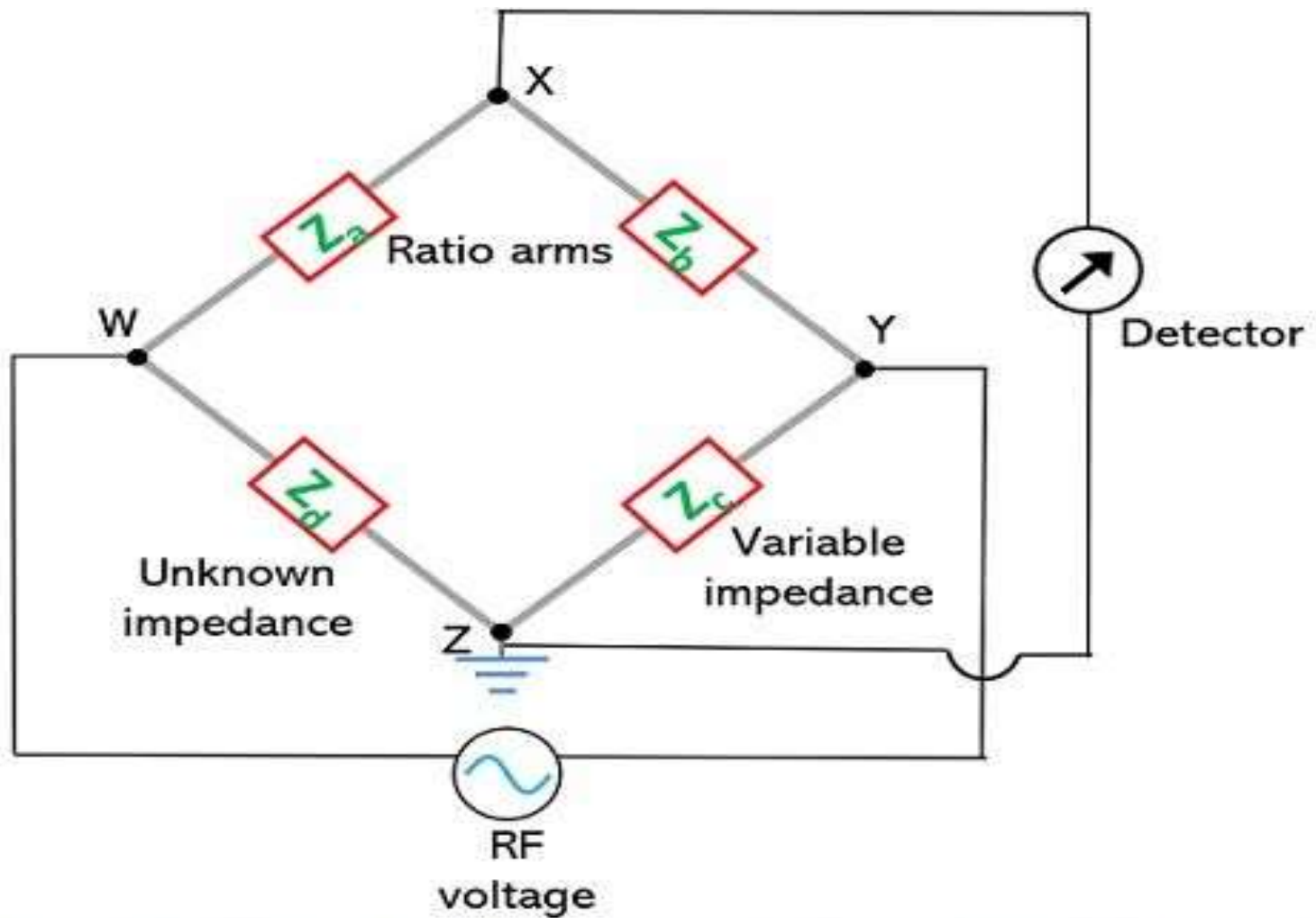

Wheat stone bridge for measurement of impedance

Electronics Desk

- Under the balanced condition of the bridge, no potential difference would exist between points X and Z thereby providing a null in the detector.

$$\frac{Z_a}{Z_b} = \frac{Z_d}{Z_c} \qquad \frac{Z_a \angle \theta_a}{Z_b \angle \theta_b} = \frac{Z_d \angle \theta_d}{Z_c \angle \theta_c}$$

- in terms of both magnitude and phase.
- both magnitude and phase balance conditions must be fulfilled.

$$Z_a Z_c \angle \theta_a + \angle \theta_c = Z_b Z_d \angle \theta_b + \angle \theta_d$$

$$Z_a Z_c = Z_b Z_d$$

$$\angle \theta_a + \angle \theta_c = \angle \theta_b + \angle \theta_d$$

$$Z_d = Z_c \left[\frac{Z_a}{Z_b} \right]$$

- need to determine the antenna input impedance then the antenna input terminal must be connected between the points W and X.
- It suits grounded vertical antennas of low frequency.
- In order to have desired results, points W and Z must be grounded initially with respect to ground.
- Due to this reason, in the beginning, the bridge is balanced with the short-circuited or open-circuited condition.

Impedance Measurement by Slotted Line Method

- known as a standing wave ratio method or standing wave method of impedance measurement.
- popular characteristics of travelling waves.
- the method tells the idea of uniquely determining the impedance through voltage or current standing wave ratio and the separation distance between voltage or current minimum and the reference point of impedance.
- It is widely used at UHF and microwave frequencies.

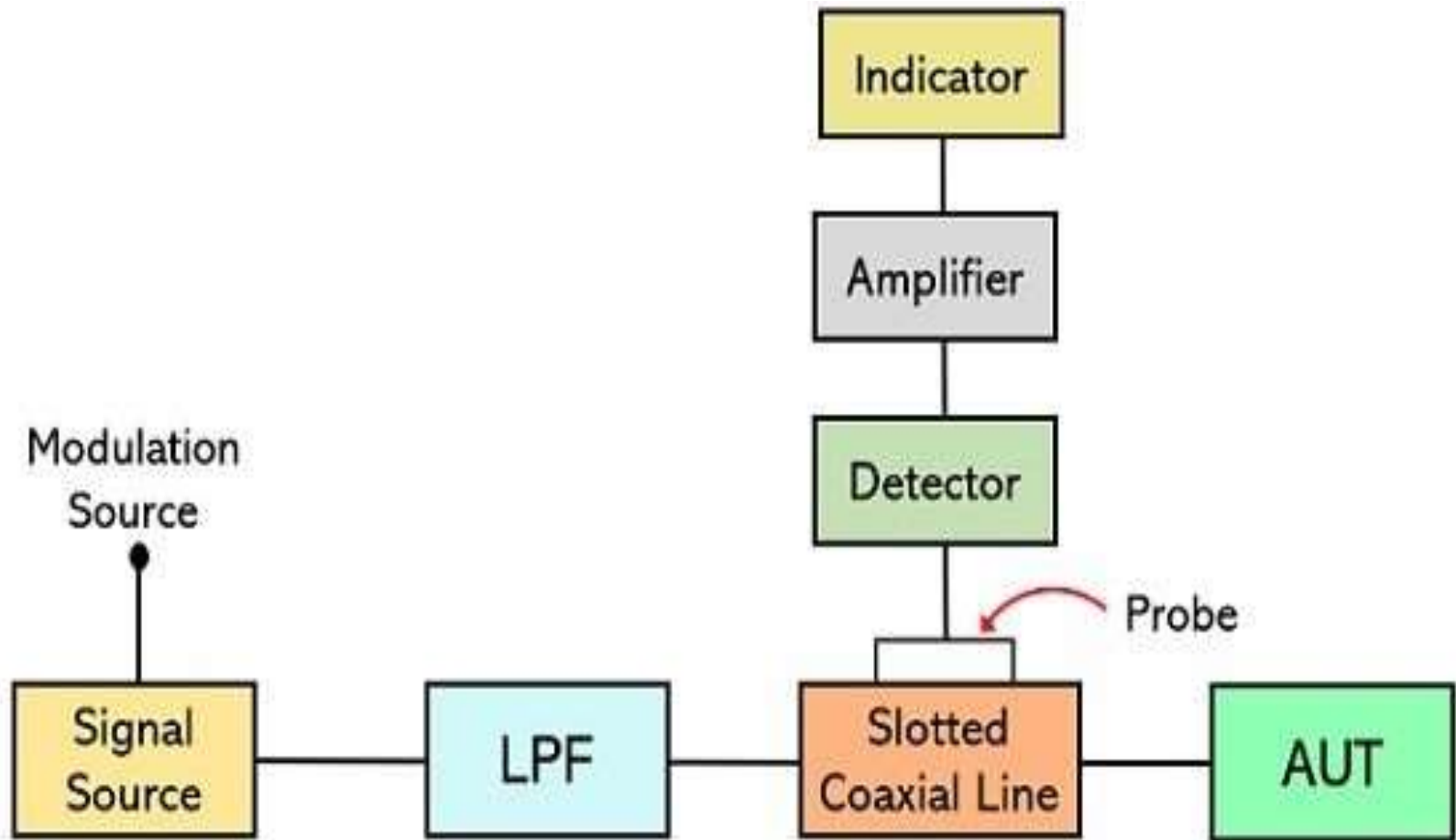

Slotted line setup for measurement of impedance

Electronics Desk

- all the devices must be connected in the same manner.
- one side a single source is present while at the other side the unknown impedance to be measured is present.
- improper termination of the antenna with the feeding transmission line gives rise to standing wave along the transmission line.
- So, a portion of the transmission line which is connected to the antenna is replaced by an axial slotted line over which a probe moves.
- for measuring the voltage in order to get the impedance a crystal detector and a micro-ammeter is used.
- at the various locations along the slotted line between the generator and the load, the probe is moved.

- The movement of the detector probe leads to providing the reading in the micro-ammeter which is noted down.
- movement in the two consecutive points of V_{\max} and V_{\min} of the probe in the slotted coaxial cable are noted.
- Resultantly the ratio of the two will provide VSWR i.e., the input impedance

$$VSWR = \frac{V_{\max}}{V_{\min}}$$

Antenna Gain Measurement

- a crucial aspect of antenna measurement.
- gain of the antenna plays a very important role in predicting the performance of an antenna.
- Gain is a fundamental parameter of the antenna.
- ability of the antenna to either direct the radiated power of the antenna in a specific direction or efficiently receive the incoming power from a specific direction.
$$\text{Gain} = \frac{\text{Max radiation intensity (test antenna)}}{\text{Max radiation intensity (reference antenna)}}$$
- It is defined as the ratio of maximum radiation intensity of the test antenna to that of the reference antenna where the input power is the same.

- **Directivity** of the antenna then it is defined as the maximum radiation intensity to the average radiation intensity of an ideal isotropic antenna.

$$\text{Directivity} = \frac{\text{Max radiation intensity}}{\text{Avg radiation intensity}}$$

$$G_0 = \alpha D$$

Methods of Antenna Gain Measurement

- there are **two standard methods** used for antenna gain measurement.
 - Gain transfer or Direct Comparison Method
 - **Absolute Gain Method**

Direct Comparison Method

- In this method of gain measurement, comparison between signal strengths of the unknown gain antenna and the standard gain antenna is made.
- Basically, the standard gain antenna is the one with known gain.
- The standard antenna and test antenna together form an arrangement of the primary antenna.
- While the secondary antenna in this arrangement is an arbitrary transmitting antenna with unknown gain.

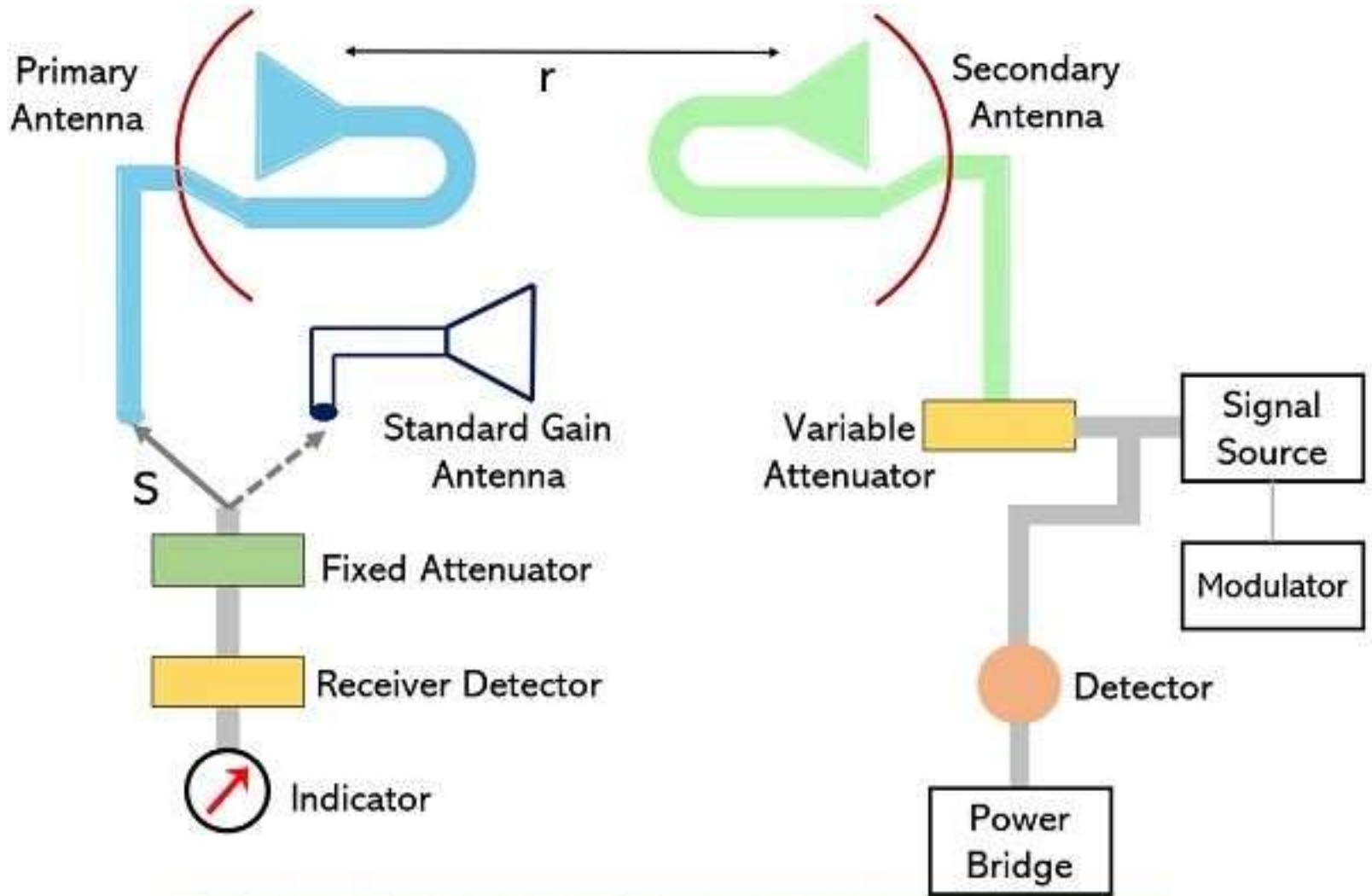

Gain Measurement By Comparison Method

Electronics Desk

- considerable distance between standard and test antenna is maintained so as to avoid the chances of coupling or any type of interaction.
- Generally, an electromagnetic horn antenna is used as a standard gain antenna.
- the pattern measurement that the distance requirement of the arrangement is such that $r \geq 2d^2/\lambda$.
- the distance between the primary and secondary antenna must be properly maintained.
- As standard and test antennas are acting as a unit thus to have appropriate matching with the load, an attenuator pad is placed at the receiver input.

- during the whole measurement there must not be fluctuation in the frequency of the power radiated towards the primary antenna.
- So, to ensure this, power level indicating device or power bridge is used at the transmitter.

The steps are as follows

- Initially, the standard antenna with a known gain is connected to the receiver using the switch S and it is directed towards the direction of maximal signal intensity of the transmitting antenna (i.e., secondary antenna).
- With the properly applied input to the secondary antenna, reading of the receiver is noted. Along with this, the reading of the attenuator dial (W_1) and power bridge (P_1) is also noted down.
- the switch is removed from the standard antenna and with the help of same switch connection of the test antenna is made with the receiver.
- Further, the reading of the attenuator dial is adjusted to get the same reading on the receiver as it was in the case with the standard antenna. Let the dial setting be W_2 and power bridge reading is P_2 .

$$G_P = \frac{W_2}{W_1}$$

$$G_P(\text{db}) = W_2(\text{db}) - W_1(\text{db})$$

$$P = \frac{P_1}{P_2}$$

$$10 \log P_1/P_2 = P(\text{db})$$

$$G = G_P * \frac{P_1}{P_2}$$

$$G = \frac{W_2}{W_1} * \frac{P_1}{P_2}$$

$$G = G_P * P$$

Absolute Gain Method

- calibrate the gain using two or three arbitrary antennas.
- two antennas (transmitting and receiving) are separated at a distance r .
- Here, P_t and P_r represent the transmitted and received power respectively.
- While A_{et} and A_{er} is the effective apertures of the transmitting and receiving antennas.
- As the two antennas are identical.

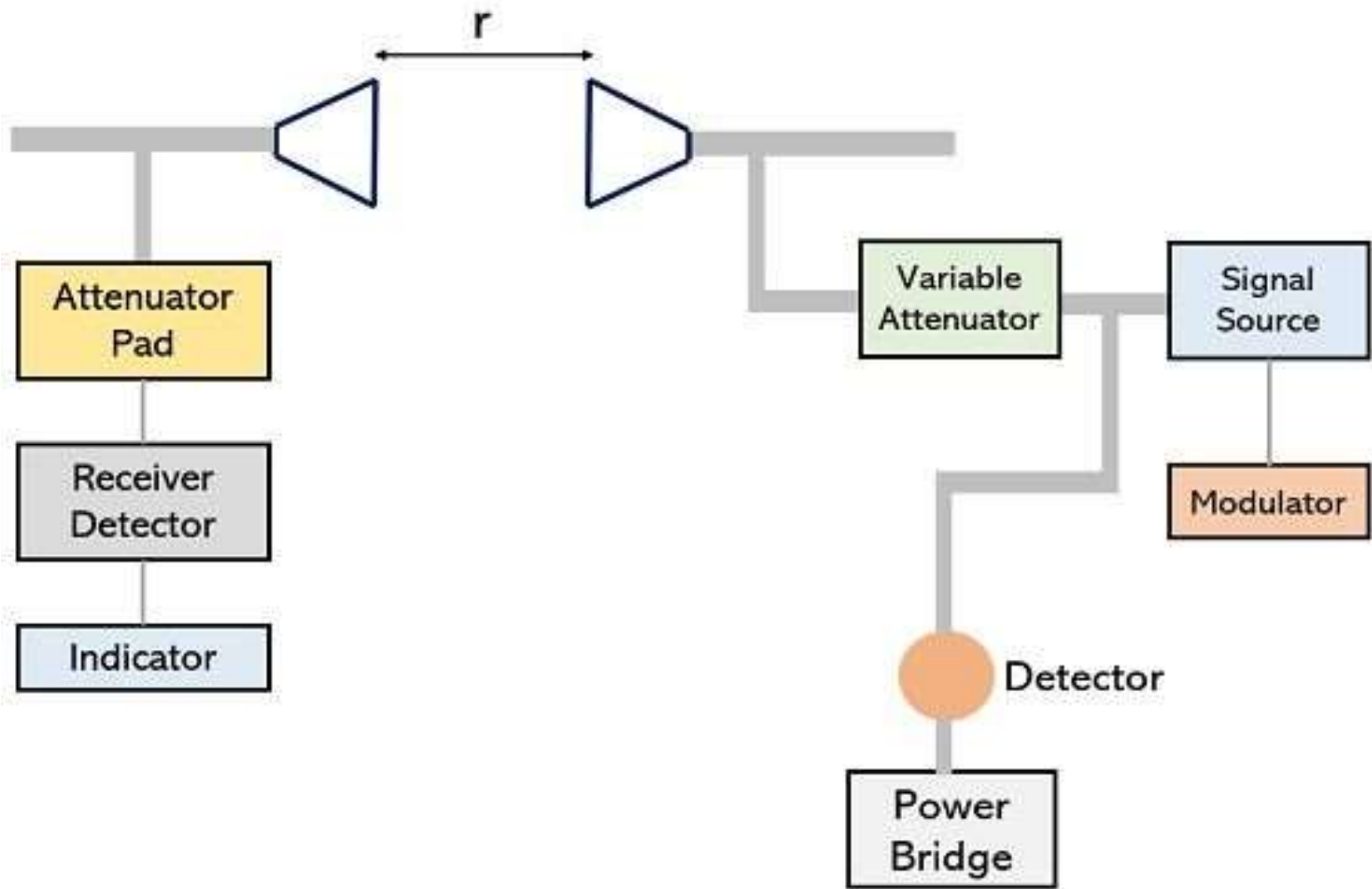

Transmitting and Receiving Antennas

Electronics Desk

$$A_{et} = A_{er} = \frac{G_0 \lambda^2}{4\pi}$$

$$\frac{P_r}{P_t} = \left(\frac{G_0 \lambda}{4\pi r} \right)^2$$

- By Friis's transmission equation,

$$\sqrt{\frac{P_r}{P_t}} = \frac{G_0 \lambda}{4\pi r}$$

$$\frac{P_r}{P_t} = \left(\frac{A_{et} A_{er}}{\lambda^2 r^2} \right) = \left(\frac{G_0 \lambda^2}{4\pi} \right) \left(\frac{G_0 \lambda^2}{4\pi} \right) \frac{1}{\lambda^2 r^2}$$

$$G_0 = \frac{4\pi r}{\lambda} \sqrt{\frac{P_r}{P_t}}$$

- While if we consider the effect of direct and indirect rays in case of ground reflection then,

$$G_0 = \frac{4\pi r}{\lambda F} \sqrt{\frac{P_r}{P_t}}$$

F is the propagation constant due to interference.

Antenna Measurements – Radiation Pattern

- way of determining the radiation pattern of the antenna under test i.e., AUT.
- Antenna pattern or radiation pattern graphically represents the radiation properties of the antenna with respect to the space coordinates.
- it refers to the measurement of relative magnitude and phase of the electromagnetic signal transmitted by the test antenna.
- AUT is considered in conjunction with a source antenna that helps in determining system performance.

Procedure for Pattern Measurement

- setup must necessarily have two antennas.
- One is the antenna under test referred as a primary antenna while the other is the secondary antenna.
- the system follows reciprocity theorem.
- the radiation pattern will be the same for both the antenna thus out of the two any one of them can be the transmitting antenna while the other will be the receiving antenna.

Procedure I

- the primary antenna is placed at a specific location and is of immobile nature.
- Whereas, the secondary antenna is placed at a certain distance from it.
- However, the secondary antenna is not stationary as it moves around the primary antenna maintaining that specific distance.
- Generally, the primary antenna is the transmitting one while the secondary is the receiving antenna, but this condition is not necessary for the measurement to take place.

Procedure II

- measurement of antenna both primary as well as secondary antennas are placed at fixed positions separated by a sufficient distance.
- under a general condition, the primary antenna is considered as the transmitting one while the secondary antenna is the antenna under test.
- Here the positions of the two antennas are fixed but the secondary antenna is rotated about the vertical axis.

- during the rotation of the test antenna about the vertical axis, the primary antenna is fixed and is not rotated.
- So, when the transmitting antenna provides the illumination to the test antenna at different angles then field strength at various directions is noted down by stopping the rotation each time at some specific angle.

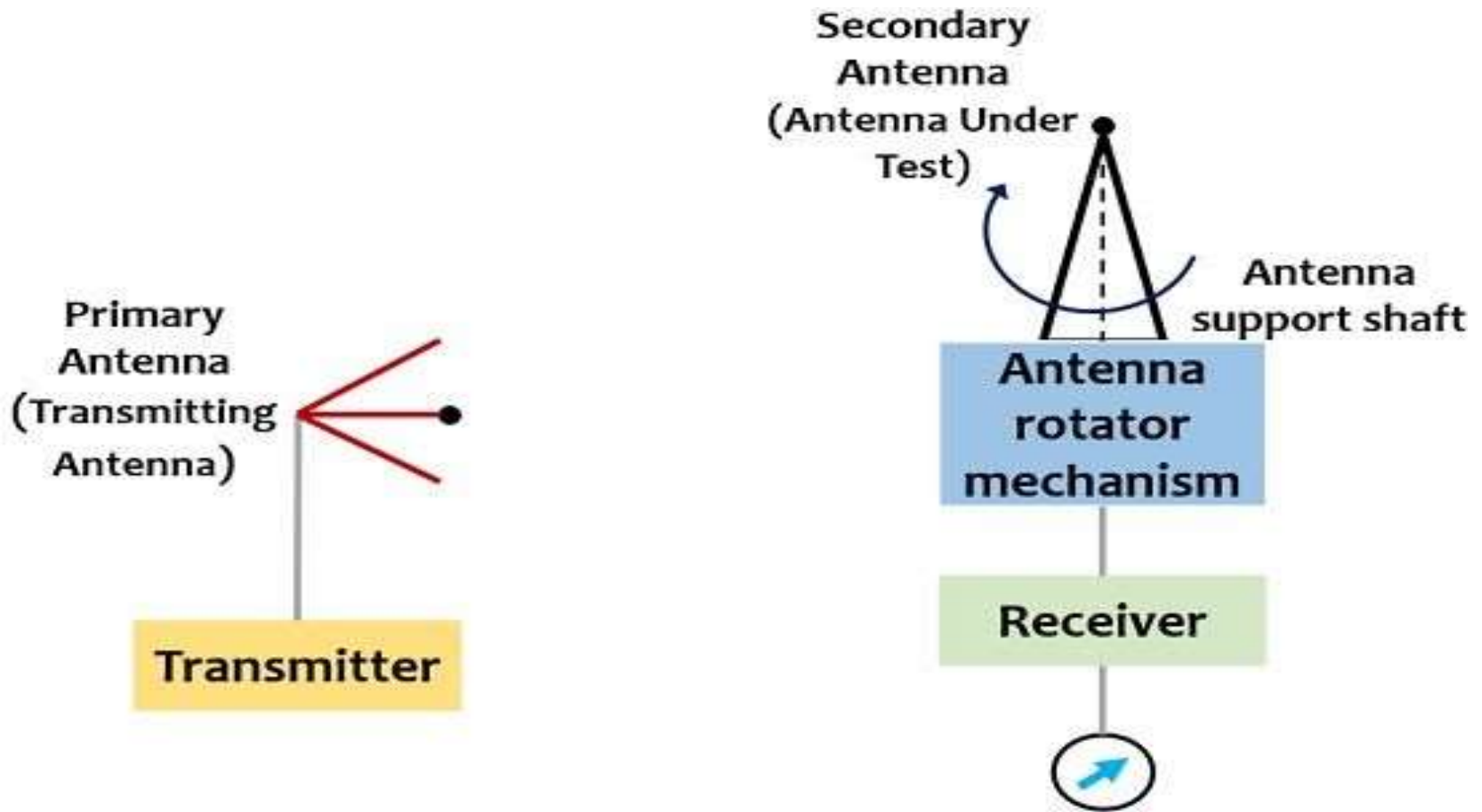

Set up to measure antenna radiation pattern

Electronics Desk

- The *two major requirements* of pattern measurement are as follows:

- Distance and
- Uniform Illumination

$$r \geq \frac{2d^2}{\lambda}$$

- Uniform Illumination:
 - transmitting antenna must possess a uniform amplitude and phase over the complete distance of separation.
 - Here the reflections from the ground, buildings, trees, etc. must be greatly avoided.

Phase Measurements

- The phase is a relative quantity - that is, it **must be measured relative to some fixed reference**.
- In this method the test antenna is used as the source antenna, and another antenna is used to receive the fields.
- the **observation point is not too far from the test antenna, so that the source waveform feeding the test antenna can also be run into a phase measurement box**.
- This **box compares the locations of the peaks and valleys of the received signals and determines the relative phase from this information**.
- The **receive antenna is moved and then the process is repeated**.

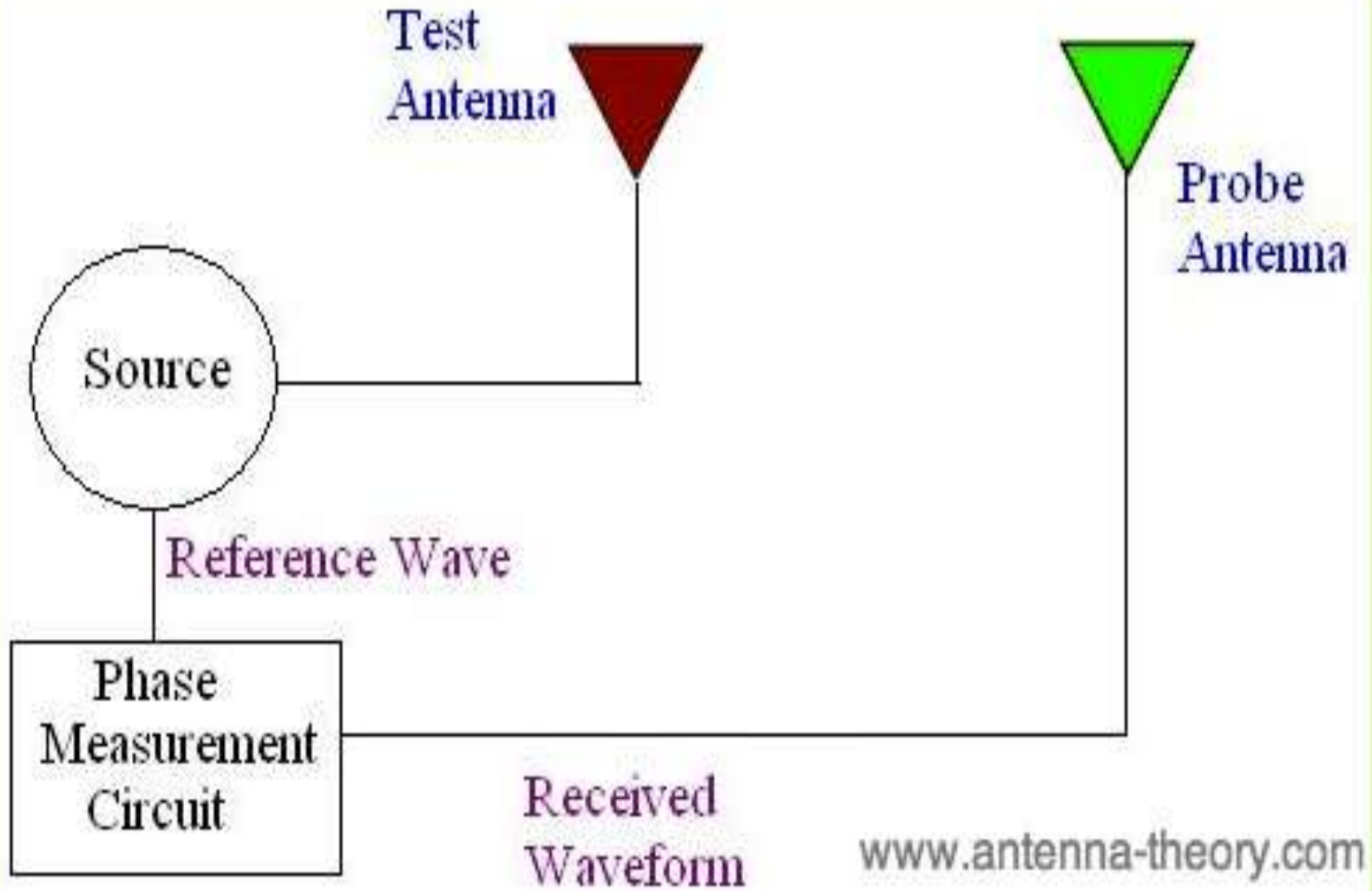

- If the test antennas are very far from each other and the reference (source) waveform can not be fed directly into the phase measurement circuit (this happens at low frequencies and large outdoor ranges where many wavelengths becomes a large distance), then a standard antenna with known phase characteristics is used to transmit a wave, which is used to compare with the received signal from the test antenna.

Polarization Measurements

- use a linearly polarized antenna (typically a half-wave dipole antenna) as the receive antenna.
- The linearly polarized receive antenna **will be rotated, and the received power recorded as a function of the angle of the receive antenna.**
- the **test antenna must be rotated so that the polarization can be determined for each direction of interest.**

- The power is recorded for the fixed position (orientation) of the receive antenna, then it is rotated about the x-axis & the power is recorded again.
- This is done for a complete rotation of the linearly polarized receive antenna.

Test Antenna

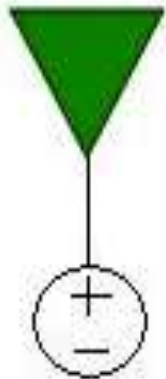

Source

**Linearly Polarized
Receive Antenna**

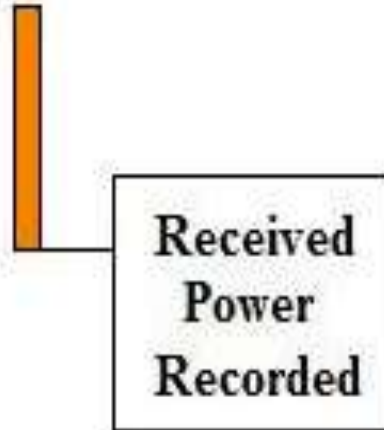

www.antenna-theory.com

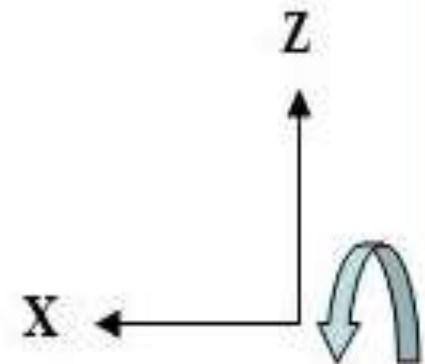

Receive Antenna Rotated Around X-axis and Power is Recorded For each Angle

Helical antenna

- an example of wire antenna and itself forms the shape of a helix.
- Provides **circularly polarized waves**.
- Frequency Range: is around **30MHz to 3GHz**.
- This antenna works in **VHF** and **UHF** ranges.

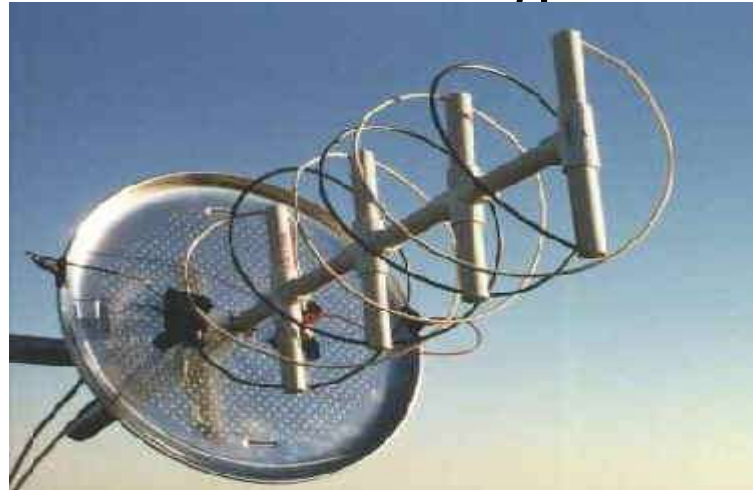

Construction

- **Helical antenna** or helix antenna is the antenna in which the conducting wire is wound in helical shape and connected to the ground plate with a feeder line.
- It is the simplest antenna.
- It is used in extra-terrestrial communications in which satellite relays etc., are involved.

- It consists of a helix of thick copper wire or tubing wound in the shape of a screw thread used as an antenna in conjunction with a flat metal plate called a ground plate.
- One end of the helix is connected to the center conductor of the cable and the outer conductor is connected to the ground plate.
- The radiation of helical antenna depends on the diameter of helix, the turn spacing and the pitch angle.

- The excitation to the helical antenna is provided at an end using a coaxial transmission line. Here the central conductor is attached to the helix and outer conductor forms a connection with the ground plane.

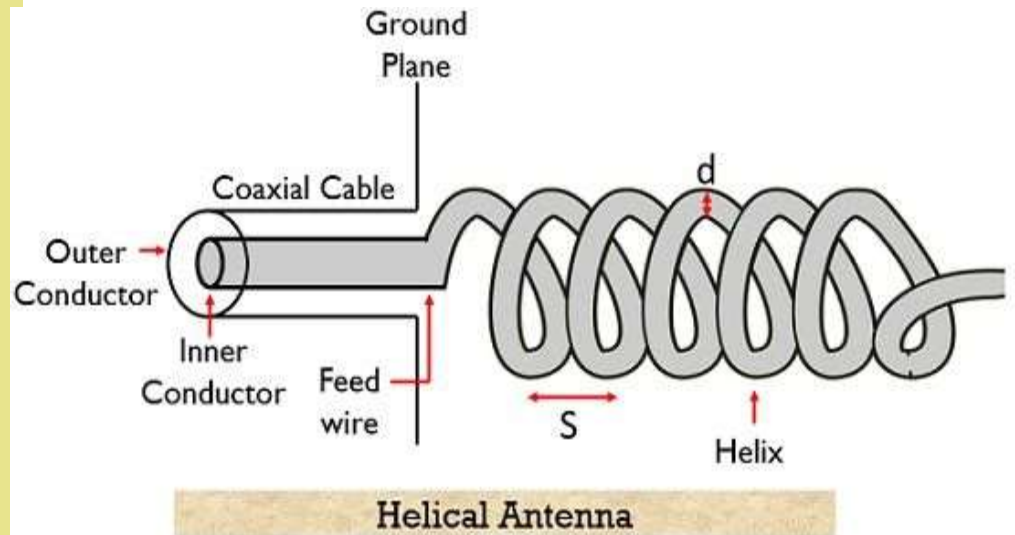
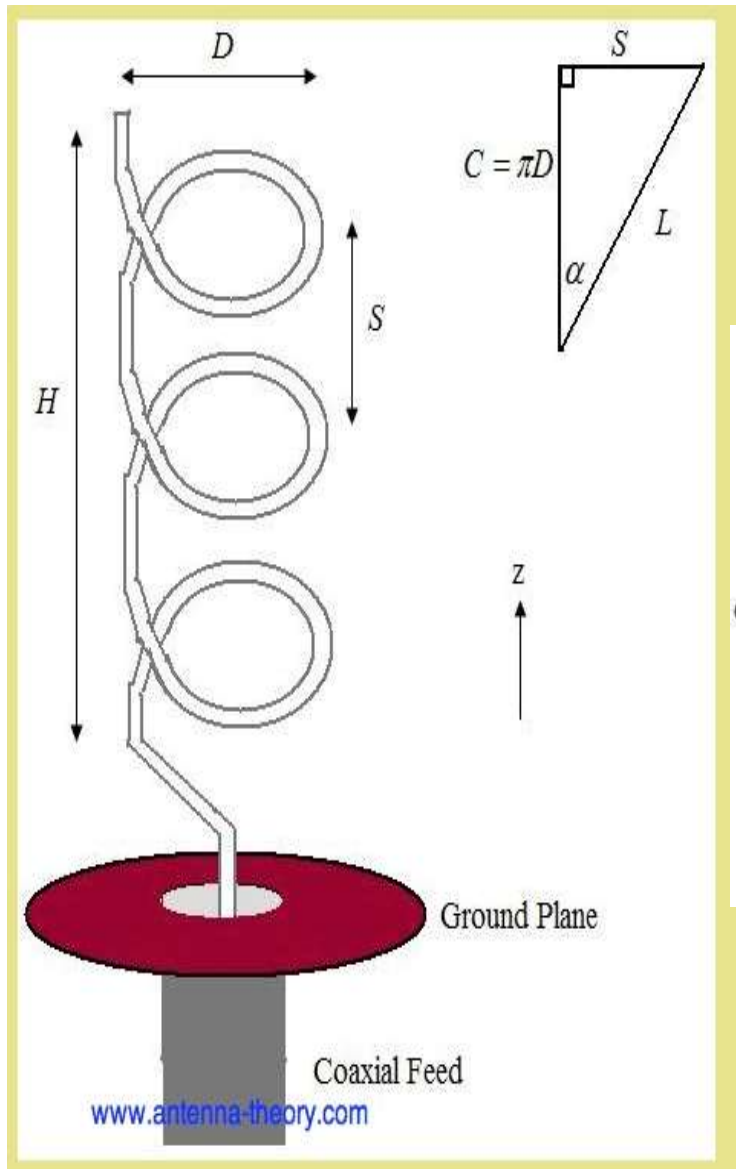

Electronics Desk

- **Pitch angle (α)** is the angle between a line tangent to the helix wire and plane normal to the helix axis.

$$\alpha = \tan^{-1}(S/C)$$

- $C = \pi D$

- where,

- **D** is the **diameter** of helix.

- **S** is the **turn spacing** (centre to centre).

- **α** is the **pitch angle**.

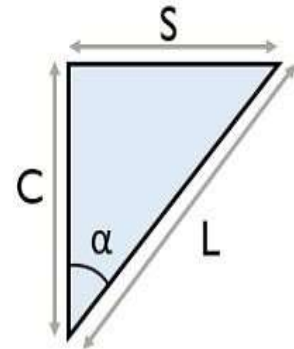

Relation between turn length, spacing and circumference

$$L = \sqrt{S^2 + C^2}$$
$$L = \sqrt{S^2 + (\pi D)^2}$$

The **pitch angle** of the helix is the angle existing between the tangential line to the helical wire and the plane in direction, normal to its axis.

Thus $\tan \alpha = \frac{S}{C} = \frac{S}{\pi D}$

Hence $\alpha = \tan^{-1}\left(\frac{S}{\pi D}\right)$

$$\frac{3\lambda}{4} \leq C \leq \frac{4\lambda}{3}$$

Working of Helical Antenna

- When a conductive wire is excited by using feed lines like coaxial cable or two-wire transmission line then current flows through the conducting wire.
- These causes the generation of field lines and radiations are emitted.
- **Modes of Operation:**
- The predominant modes of operation of a helical antenna are –
 - **Normal** or perpendicular mode of radiation.
 - **Axial** or end-fire or beam mode of radiation.

Modes Helical Antenna – Normal Mode

- This mode of operation is also known as **perpendicular mode** of operation; this is so because, in this mode, maximal radiation is emitted in the direction of the plane perpendicular to the axis of the antenna.
- And the waves are **circularly polarized in nature**.
- This means that the field radiated is maximum along the plane perpendicular to axis and minimum along the axis.
- This mode of operation is achieved when the dimensions of the antenna are comparatively smaller than the wavelength. This means

$$NL \ll \lambda$$

- However, this small dimensional antenna offers **low radiation efficiency** and **very narrow bandwidth**.

- The radiation field is normal to the helix axis.
- This mode of radiation is obtained if the dimensions of helix are small compared to the wavelength.
- The radiation pattern of this helical antenna is a combination of **short dipole** and **loop antenna**.
- It depends upon the values of diameter of helix-**D** and its turn spacing-**S**.
- **Drawbacks** of this mode of operation is **low radiation efficiency** and **narrow bandwidth**. Hence, it is **hardly used**.

- Offers **low radiation efficiency** and **very narrow bandwidth**.
- The antenna in this configuration is known as broadside helical antenna and acts as an electric short dipole antenna.
- The reason behind this is that at $\alpha = 0^\circ$, the helix corresponds as loop and at $\alpha = 90^\circ$, it acts as a linear dipole.
- Therefore, patch angle at 0° and 90° serves as the limiting conditions of the helical antenna.

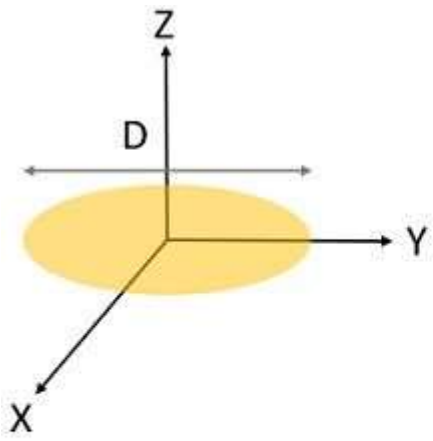

Loop, $\alpha = 0^\circ$

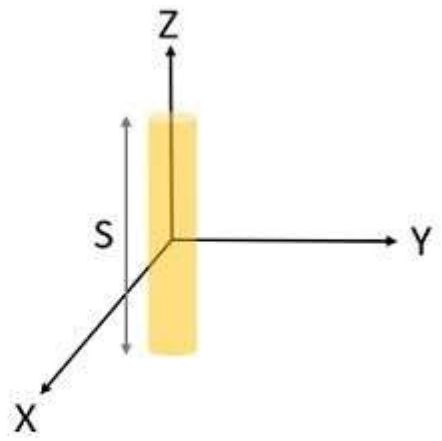

Short dipole, $\alpha = 90^\circ$

Limiting conditions of Helical Antenna

Electronics Desk

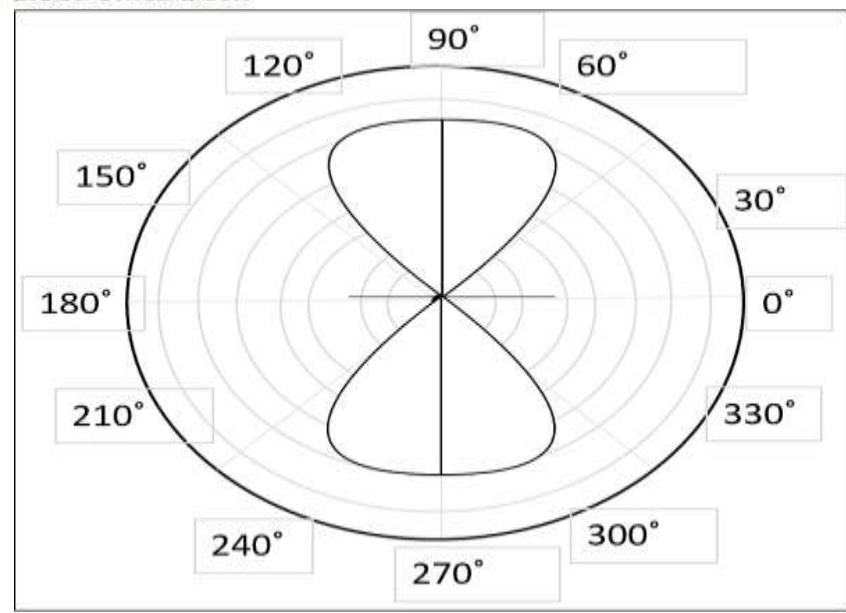

Axial Mode

- In **axial mode** of radiation, the radiation is in the end-fire direction along the helical axis and the waves are circularly or nearly circularly polarized.
- This mode of operation is obtained by raising the circumference to the order of one wavelength (λ) and spacing of approximately $\lambda/4$.
- The radiation pattern is broad and directional along the axial beam producing minor lobes at oblique angles.

- If this antenna is designed for right-handed circularly polarized waves, then it will not receive left-handed circularly polarized waves and vice versa.
- This mode of operation is generated with great ease and is **more practically used**.
- The **crucial differentiating factor** between normal mode and axial mode is that in normal mode, maximum radiation is along the perpendicular direction of the axis. While in axial mode, maximum radiation is along the axis itself.

$$NL \approx \lambda$$

- For axial mode, the pitch angle shows variation between 12° to 18° .
- However at 14° this mode shows best results.

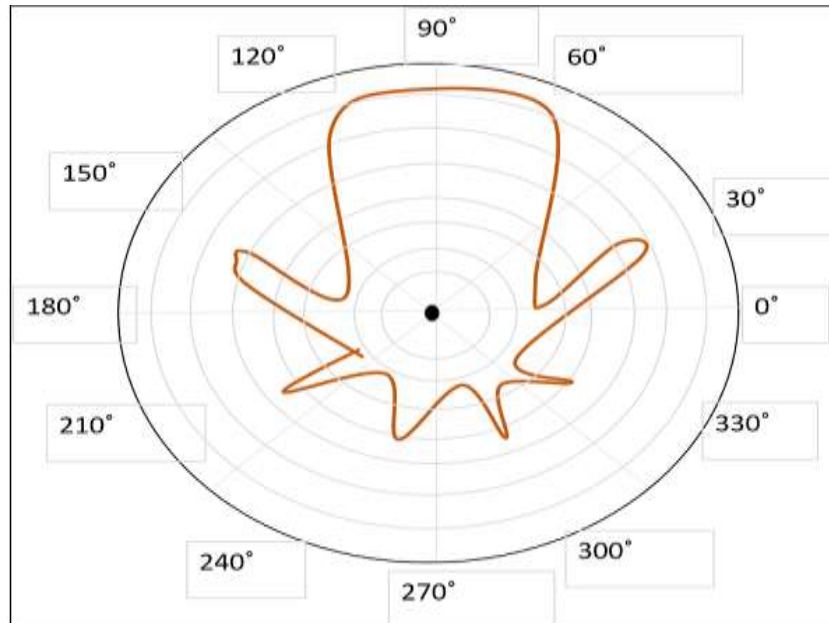

Radiation Pattern

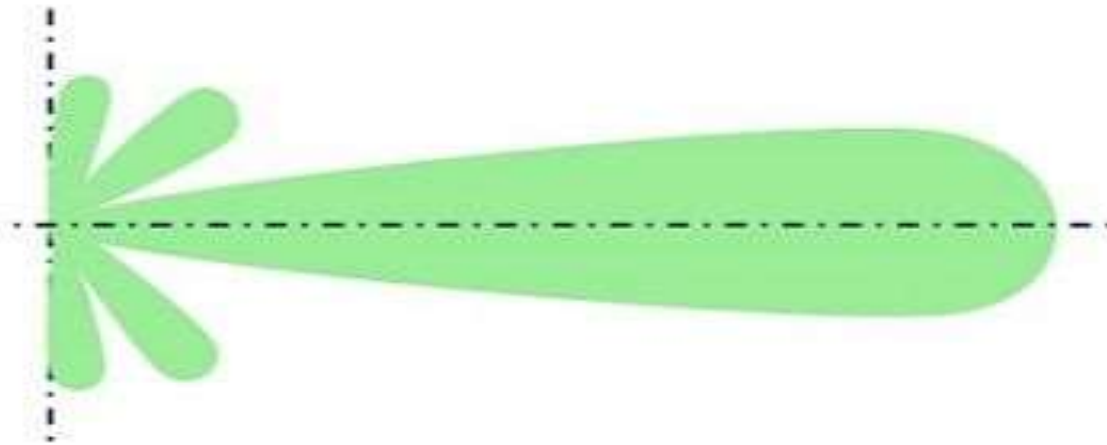

Radiation pattern of
helical antenna in
axial mode

Electronics Desk

- Advantages
 - Simple design
 - Highest directivity
 - Wider bandwidth
 - Can achieve circular polarization
 - Can be used at HF & VHF bands also
- Disadvantages
 - Antenna is larger and requires more space
 - Efficiency decreases with number of turns
- Applications
 - A single helical antenna or its array is used to transmit and receive VHF signals
 - Frequently used for satellite and space probe communications
 - Used for telemetry links with ballistic missiles and satellites at Earth stations
 - Used to establish communications between the moon and the Earth
 - Applications in radio astronomy

Features

- This is a simple antenna used for circular polarization.
- It is utilized in different bands like VHF & UHF.
- It is most commonly used in axial mode.
- It is not chosen in normal mode where efficiency and beam-width are small in this mode.
- Its design is very simple & has maximum directivity.
- In axial mode, it is a wideband antenna.
- If the axial ratio is zero then, linear horizontal polarization occurs.
- If the axial ratio is infinite then linear vertical polarization occurs.
- If the axial ratio is one, then circular polarization occurs.

Lens Antenna

- we have discussed till now, used the **plane surface**.
- The lens antennas use the **curved surface** for both transmission and reception.
- **Lens antennas** are made up of glass, where the **converging** and **diverging** properties of lens are followed.
- The lens antennas are used for **HF** applications.

- These antennas consist of a dipole or horn antenna followed by a lens.
- Used at HF as they can be quite bulky at lower frequencies.
- The size of the lens used depends on the operating frequency - the higher the frequency the smaller the lens.
- uses the convergence and divergence properties of a lens to transmit and receive signals.
- The frequency range -starts at 1000 MHz but its use is greater at 3000 MHz and above.

- A normal glass lens works on the principle of refraction.





- The principle of refraction utilized by the optical lens for light in order to re-radiate the received energy in the desired direction.
- **Definition:** The lens antenna is 3-D electro-magnetic device which has refractive index other than unity.

It consists of electro-magnetic lens along with feed. This antenna is similar to glass lens used in optical domain.

- **Definition:** A type of antenna that is designed to collimate the incident divergent energy in order to convert it into plane waves using proper lens material is known as **Lens Antenna**.

Functions Of A Lens Antenna

- It generates plane wavefront from spherical.
- It forms incoming wavefront at its focus.
- It generates directional characteristics.
- It is used to collimate electromagnetic rays.
- It controls aperture illumination.

- Lens antenna is regarded as a **radiator which operates on collimated action of optical lens.**
- Its operation is similar to **Reflector Antennas**.
- the reflector antenna that allows the energy falling on its surface to collimate in the desired direction.
- Thus, results in **converting the spherical waves into plane waves.**
- This causes an **increase in the directive gain offered by the antenna arrangement.**
- Similar to a **Parabolic Reflector**, a lens antenna is designed to collimate the incident energy which is diverging in nature, in the desired direction.
- This prevents the undesired spreading of the energy thereby improving the efficiency.

Operating Principle

- Lens antennas use the *principle of the converging lens* in order to collimate the energy that incident on it.
- In a similar way in case of lens antenna, the point source acts as the feed that emits the microwave energy towards the surface of the optical lens.
- This optical surface forces the radiated spherical wavefronts to get changed into collimated one.

- The collimating lens is made of dielectric material which possesses the finite value of dielectric constant.
- But these can also be constructed with materials that exhibit less than unity refractive index at radio frequencies.
- It somewhat displays reciprocity theorem thus is used at the transmitting as well as receiving ends.

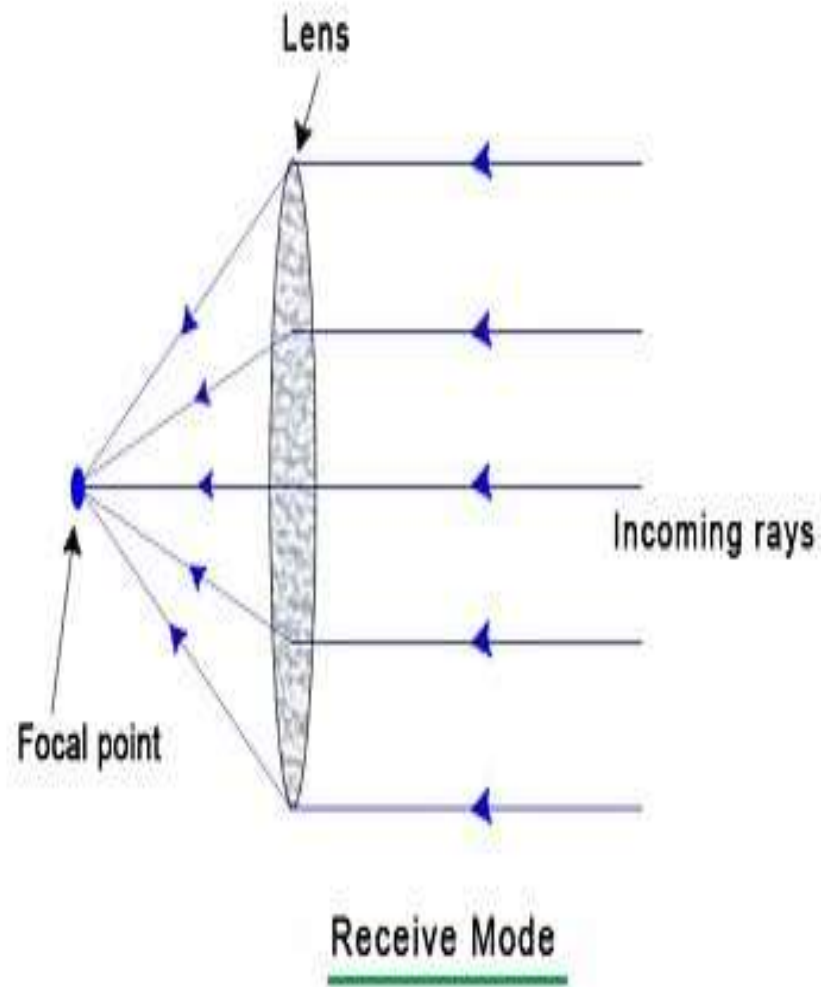
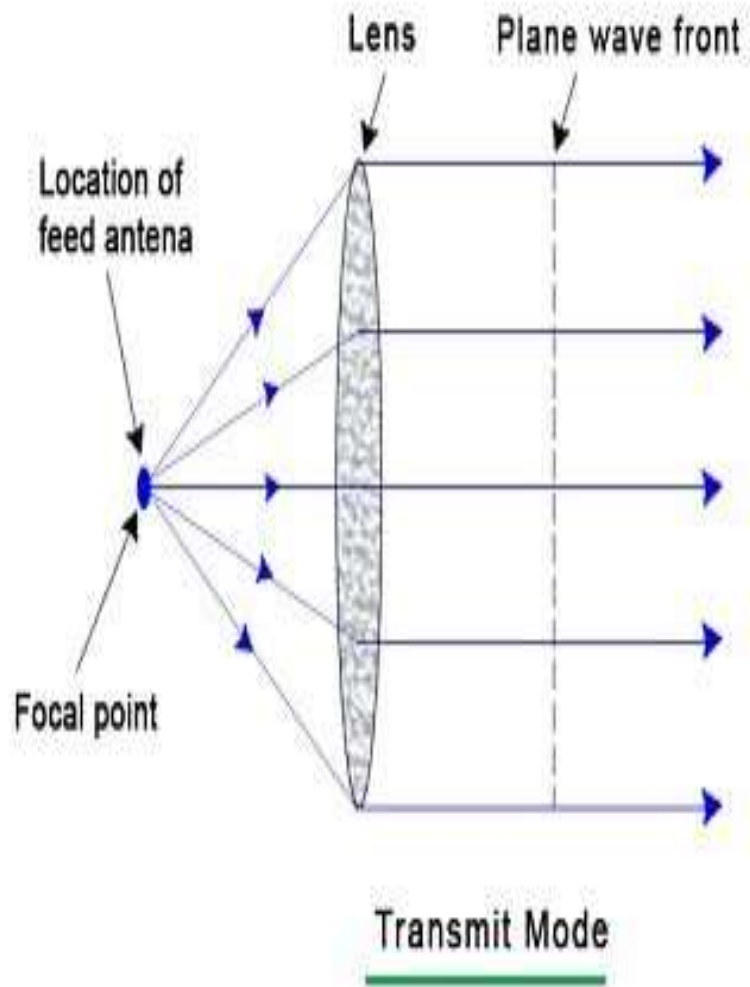

Construction of Lens Antenna

- If a light source is assumed to be present at a focal point of a lens, which is at a focal distance from the lens, then the rays get through the lens as collimated or parallel rays on the plane wavefront.
- The rays that pass through the centre of the lens are less refracted than the rays that pass through the edges of the lens.
- All of the rays are sent in parallel to the plane wave front. This phenomenon of lens is called as **Divergence**.

- The same procedure gets reversed if a light beam is sent from right side to left of the same lens.
- Then the beam gets refracted and meets at a point called focal point, at a focal distance from the lens.
- This phenomenon is called **Convergence**.

- While **transmitting**, the lens is placed in such a way that the feeding antennas is located at its focal point, this way we get collimated or parallel rays at the output of the lens.
- The **feed is usually a horn antenna** that **generates a spherical wavefront** or an antenna array that **produces a cylindrical wavefront**.
- While **receiving**, when the incident rays strike the lens they get refracted and get converged to the focal point where the receptor is located.
- These types of antennas are used for HF applications that require wide bandwidths.

- The ray diagram represents the focal point and focal length from the source to the lens.
- The parallel rays obtained are also called as **Collimated Rays**.
- It is because of this **reciprocity**, the lens can be used as an antenna, as the same phenomenon helps in utilizing the same antenna for both transmission and reception.

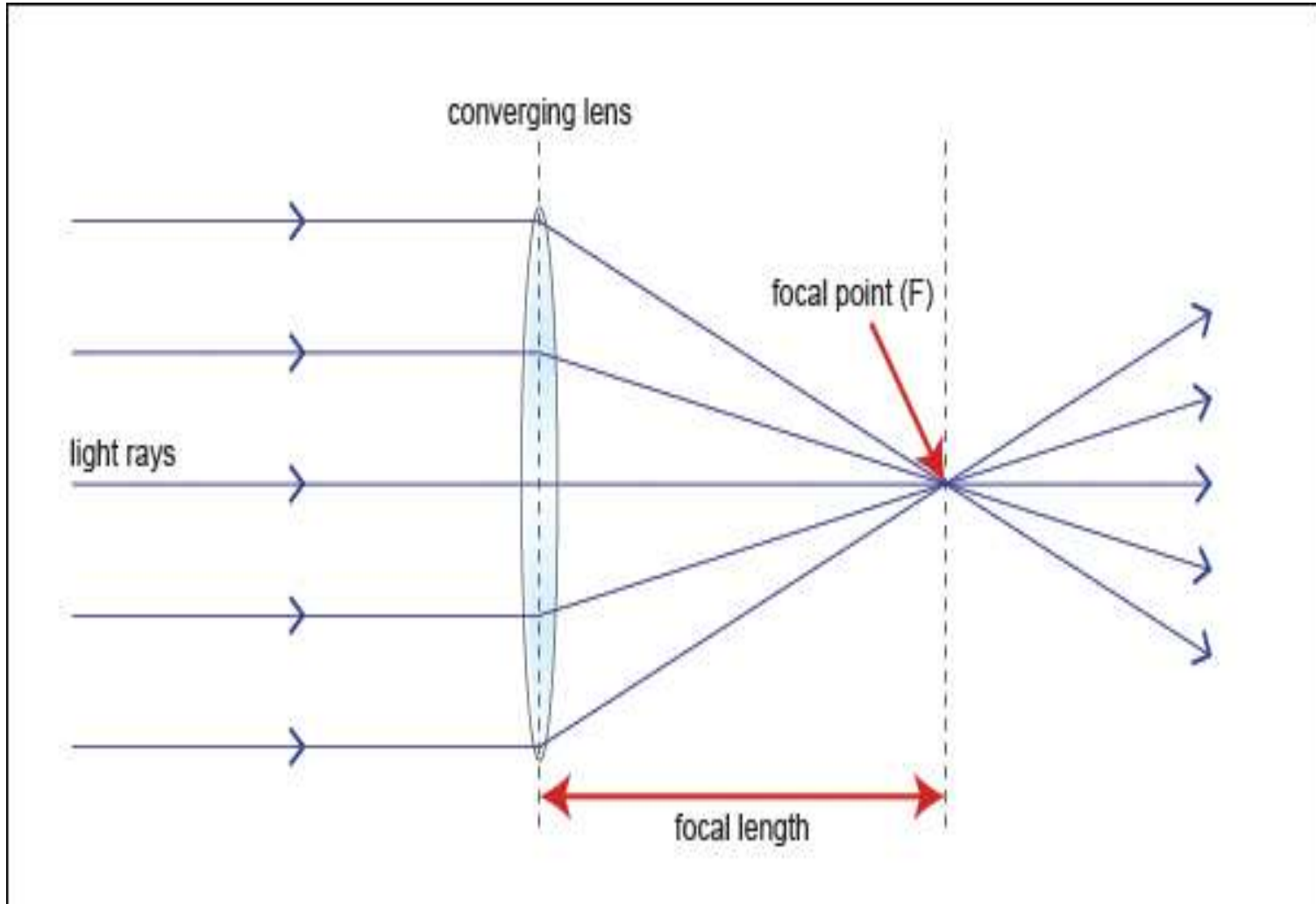

- To achieve the focusing properties **at higher frequencies, the refractive index should be less than unity.**
- Whatever may be the **refractive index, the purpose of lens is to straighten the waveform.**
- Based on this, the **E-plane and H-plane lens are developed, which also delay or speed up the wave front.**

Working of Lens Antenna

- Consider that we have a converging type of optical lens present at a certain position and source from where the energy is to be released is present at the focal point at a distance of focal length along the axis of the optical lens.

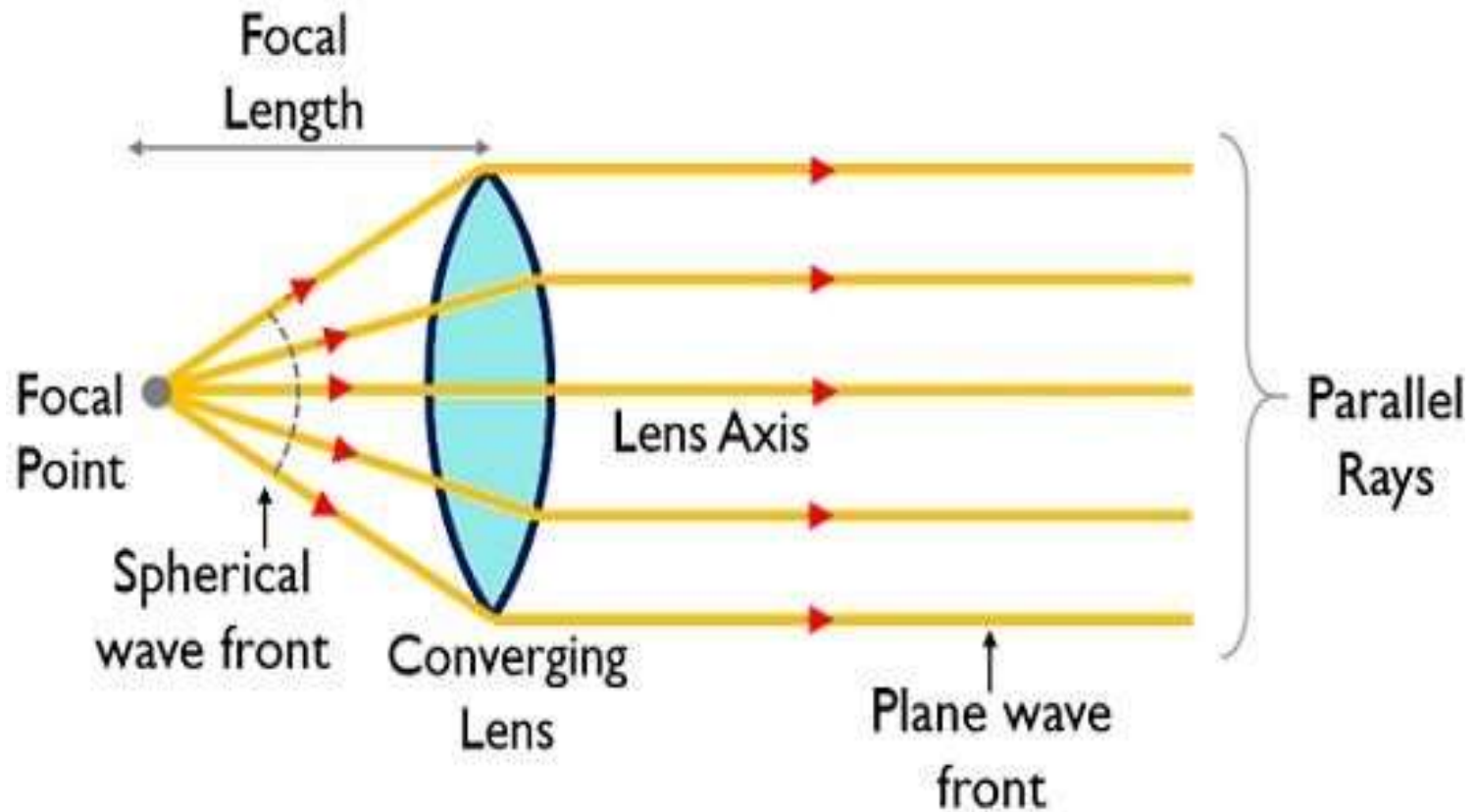

Lens in Transmitting Mode

Electronics Desk

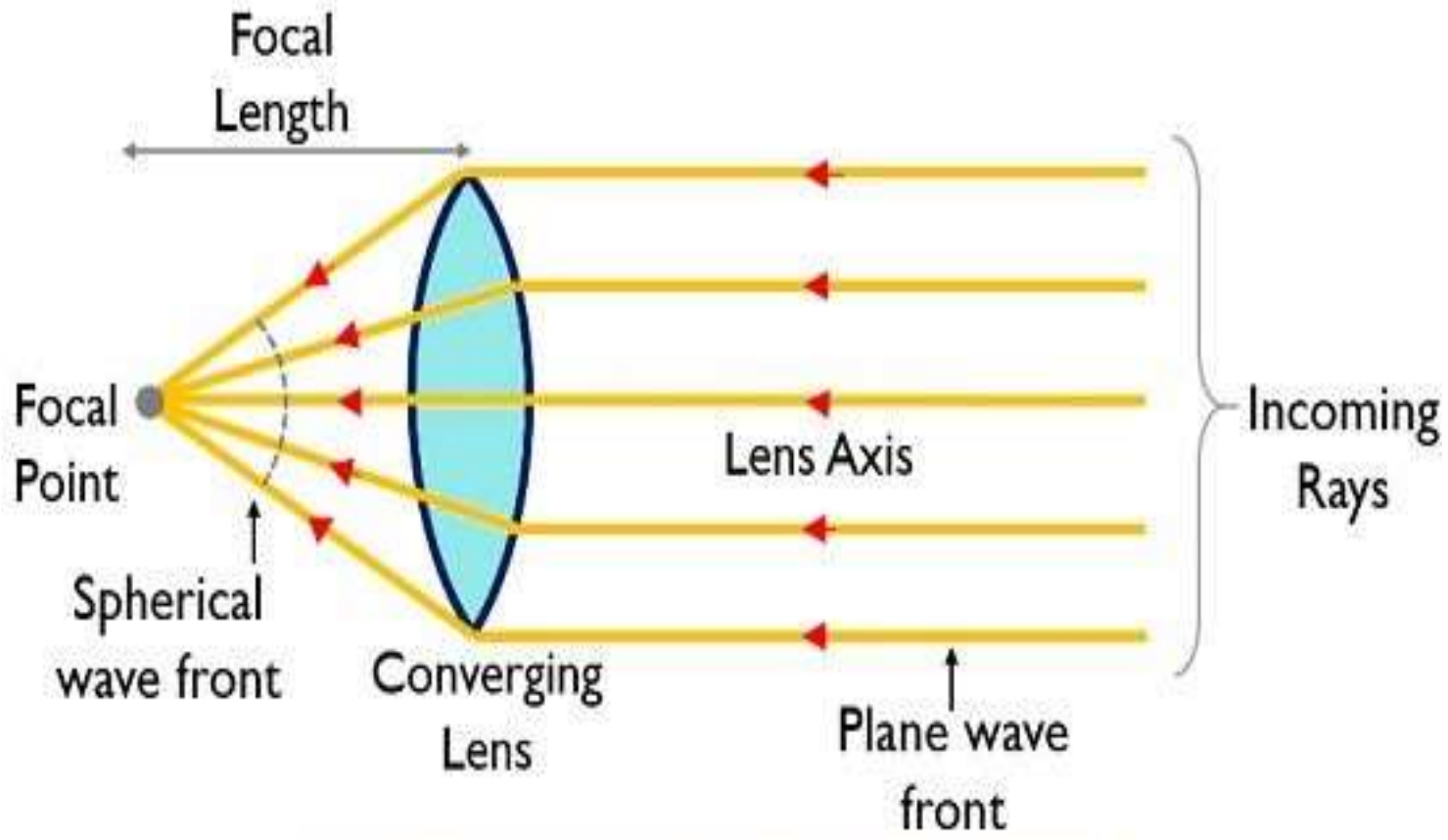

Lens in Receiving Mode

Electronics Desk

Types of Lens Antennas

- The following types of Lens Antennas are available:
 - Di-electric lens or H-plane metal plate lens or Delay lens
 - E-plane metal plate lens
 - Non-metallic di-electric type lens
 - Metallic or artificial dielectric type of lens

Dielectric Lens Antenna

- Spherical wavefront produced by primary feed antenna is converted into plane wavefront by dielectric lens.
- It is also known as **Delay Lens antenna** due to the fact that **outgoing EM rays are collimated & delayed by lens material**.
- It is useful at higher frequencies, it becomes heavy and bulky at frequencies less than 3 GHz.
- It is **made of polystyrene or lucite & polyethylene**.

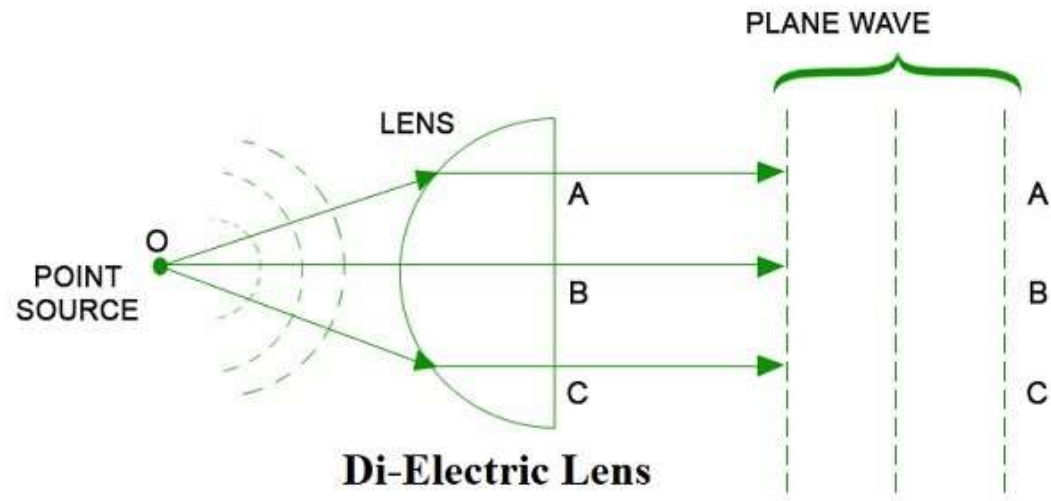
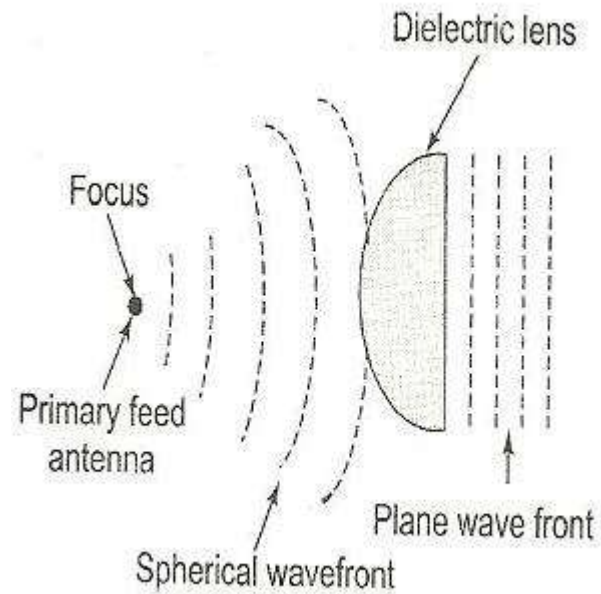

E-PLANE Metal Plate Lens Antenna

- Spherical wavefront is converted into plane wavefront but here outgoing wavefront is speeded up by material of lens.
- **Advantages**
 - feed antennas in the design do not obstruct the aperture.
- **Disadvantages**
 - they are costlier for same gain/bandwidth in comparison to reflector antenna.

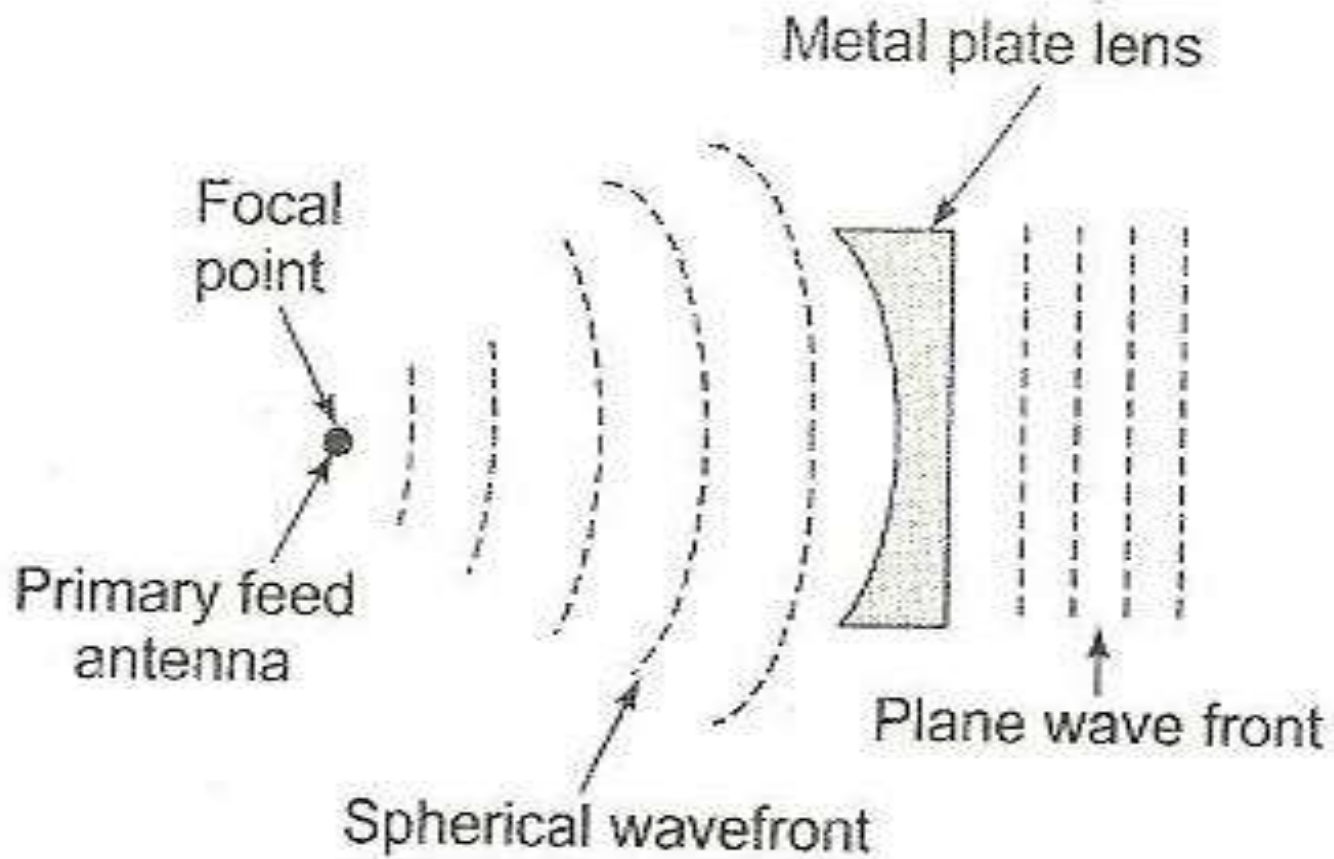

Advantages

- In lens antennas, feed and feed support, do not obstruct the aperture.
- It has greater design tolerance.
- Larger amount of wave, than a parabolic reflector, can be handled.
- Beam can be moved angularly with respect to the axis.

Disadvantages

- Lenses are heavy and bulky, especially at lower frequencies
- Complexity in design
- Costlier compared to reflectors, for the same specifications

Applications

- Used as **wide band antenna**
- Especially used for **Microwave frequency applications**
- The converging properties of lens antennas can be used for developing higher level of antennas known as Parabolic reflector antennas, which are widely used in **satellite communications**.

Log-Periodic Antenna

- The Yagi-Uda antenna is mostly used for domestic purpose.
- However, for commercial purpose and to tune over a range of frequencies - **Log-periodic antenna**.
- A Log-periodic antenna is that whose impedance is a logarithmically periodic function of frequency.
- Frequency range: around **30 MHz to 3GHz** which belong to the **VHF** and **UHF** bands.

- **Definition:** A broad band antenna that is designed **to provide such electrical characteristics that vary repeatedly in a periodic manner with logarithmic of the frequency of operation.**
- The **impedance and radiation pattern are the factors that are logarithm function of the frequency.**





Introduction

- It is a **multi-element antenna** that offers **good directivity** over a wide range of frequency of operation.
- Defined on the basis of **angles only** is categorized as a **frequency-independent antenna**.
- In such cases, the **impedance, as well as the radiation pattern both**, does not show dependency on frequency.
- **Impedance and Pattern** should **remain invariable over a range of frequency**.

- The antenna elements are **mounted on a single line along with a support boom.**
- Log periodic dipole array, the increase in the number of connected elements **improves the frequency response** or **bandwidth** that is offered by the system.

Construction of Log-periodic Antenna

- constructed by the **use of various half-wave dipole elements with a gradual increase in the length.**
- In Log Periodic Dipole Array, there is a **gradual increase in the length of the elements from point of feed to the other end, keeping the angle ' α ' constant.**
- The increase in the length of the elements along with the spacing between them in wavelength should be so **adjusted that there must be certain ratio in the dimensions of the adjacent dipoles.**

- The connection of the **feed lines** is made **either at the narrow end or apex of the array.**

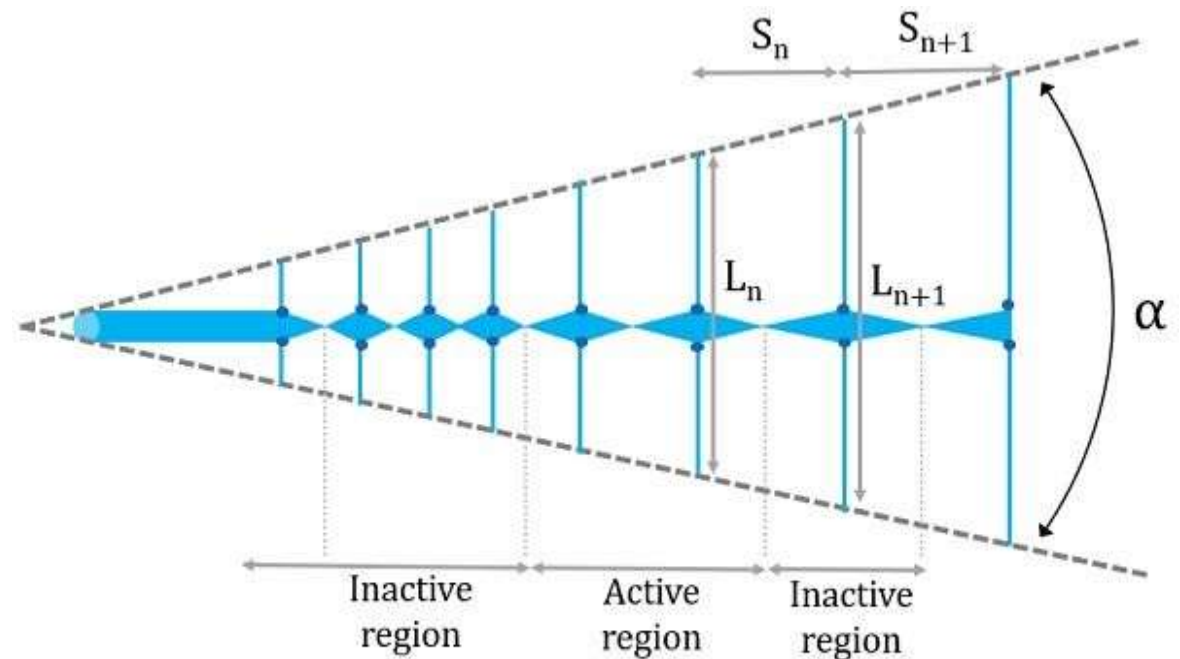
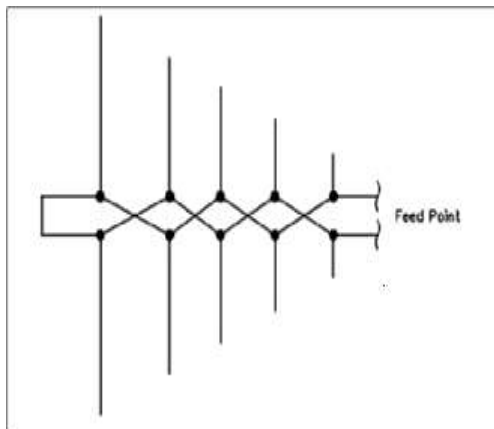

Log Periodic Dipole Array

Electronics Desk

- The construction and operation of a log-periodic antenna is similar to that of a Yagi-Uda antenna.
- The main advantage of this antenna is that it exhibits constant characteristics over a desired frequency range of operation.
- It has the same radiation resistance and therefore the same SWR.
- The Gain and front-to-back ratio are also the same.

- With the change in operation frequency, the active region shifts among the elements and hence all the elements will not be active only on a single frequency. This is its **special characteristic**.
- There are several type of log-periodic antennas such as the planar, trapezoidal, zig-zag, V-type, slot and the dipole.
- The mostly used one is log-periodic dipole array, in short, **LPDA**.

- The array consists of dipoles of different lengths and spacing, which are fed from a two-wire transmission line.
- This line is transposed between each adjacent pair of dipoles.
- The parameter that defines here the relation between the length of the antenna elements and spacing between adjacent elements is called **Design Ratio** or **Scale Factor**.
- This is denoted by τ . It is sometimes referred as **Periodicity Factor**, having a value **less than 1**.

- The length of the dipoles (L) and spacing (R or S) between them are related in the following way:

$$\frac{R_1}{R_2} = \frac{R_2}{R_3} = \frac{R_3}{R_4} = \dots = \frac{R_n}{R_{n+1}} = \tau = \frac{L_1}{L_2} = \frac{L_2}{L_3} = \frac{L_3}{L_4} = \dots = \frac{L_n}{L_{n+1}}$$

$$\frac{R_n}{R_{n+1}} = \frac{L_n}{L_{n+1}} = \tau$$

$$\frac{S_n}{S_{n+1}} = \frac{L_n}{L_{n+1}} = \tau$$

$$\frac{S_{n+1}}{S_n} = \frac{L_{n+1}}{L_n} = \frac{1}{\tau} = k$$

The value of α is generally 30° with $\tau = 0.7$.

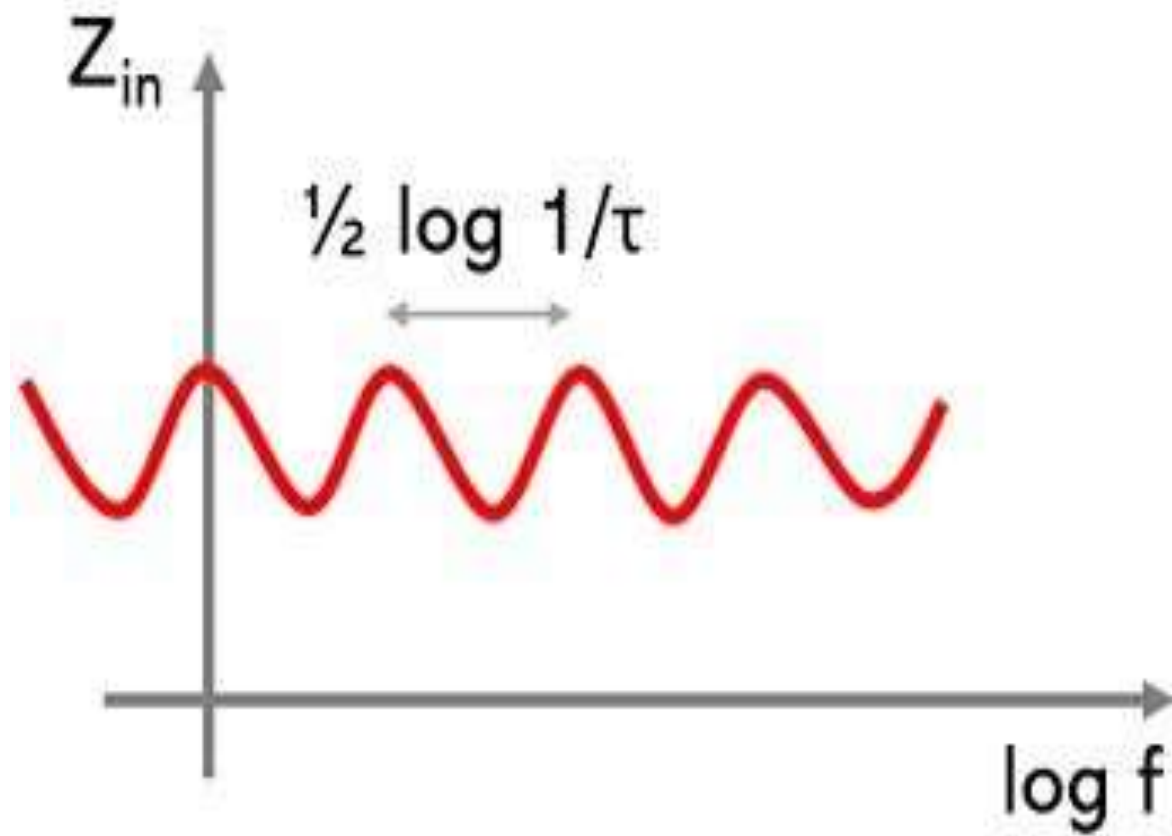

Electronics Desk

Working of Log-Periodic Antenna

- Has 3 regions:
 - Transmission line region
 - Active region
 - Reflective region
- operates only in the active region rather than the whole structure.

Transmission Line Region

- The length of the elements is shorter than the half-wavelength (i.e., resonant length).
- Provide high capacitive impedance.
- Spacing between the elements is small.
- The current flowing through the elements in this region is of small magnitude and leads the supplied voltage by 90° .
- Thus, the small current through the element results in small radiation in the backward direction.

Active Region

- Has element length equal to half wavelength and offers resistive impedance.
- Here the current through the element is large and in phase with the supplied voltage.
- Large spacing exists between the dipoles.
- Provide maximum radiation
- Frequencies where the length of the longest and shortest dipole is $\lambda/2$ is said to be the cut-off frequency.
- For maximum frequency - the active region will be towards the apex,
- For intermediate frequency - the region will shift towards the middle region of the structure.
- For minimum frequencies - near the region of longest elements.

Reflective Region

- The region having elements with length greater than resonant length (i.e., $\lambda/2$) becomes the inactive region.
- The impedance is inductive in nature that leads to generate a current that lags the supplied voltage.
- It is to be noted here that this region receives very small voltage from the transmission line.
- Because the active region attracts and radiates the maximal radiation.

Radiation Pattern

- Offer **bidirectional** as well as **unidirectional** radiation pattern depending upon the **log periodic structures**.
- Basically, a **structure with a single active region**, there will be a **unidirectional radiation pattern**.

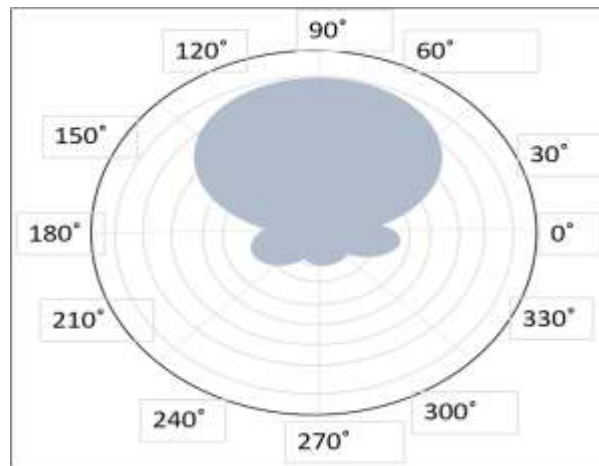

- But if there **exist two active regions**, there will be a **bidirectional radiation pattern**.

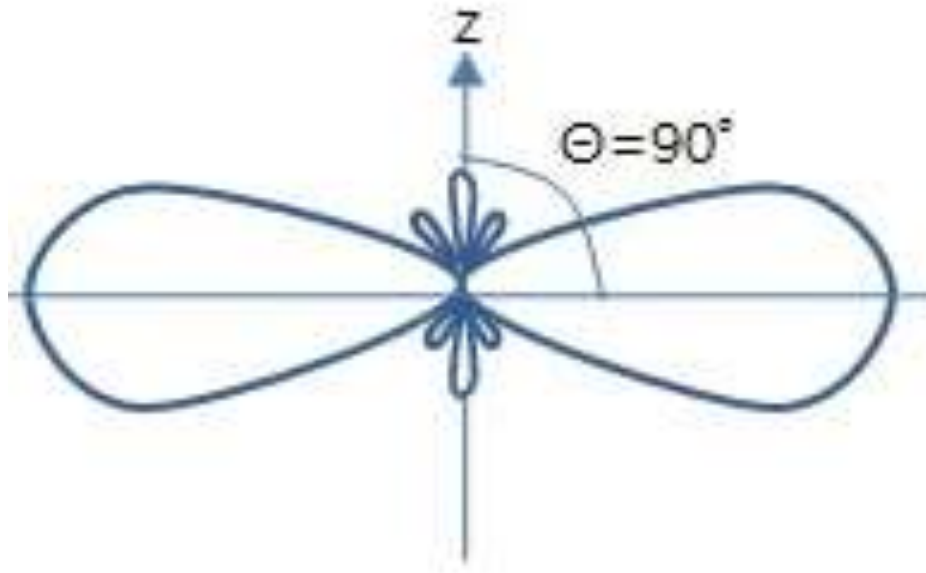

Characteristics

- The excitation to the LPDA is provided at the shorter length side in case of the single active region while at the centre in case of two active regions log periodic.
- To have a unidirectional radiation pattern, the structure must radiate towards the shorter element (i., left direction) and negligible towards the right.
- The transmission line inactive region must possess desired characteristic impedance with very small or negligible radiation.
- In the active region, to have strong radiation, the magnitude and phase of the currents must be proper.

Advantages

- The antenna design is compact structure.
- Gain and radiation pattern are varied according to the requirements.
- These offer negligible loss of power when terminated.

- **Disadvantages**

- **External mount.** The mounting platform must be of sufficient strength to hold the elements.
- **Installation cost is high.**

- **Applications**

- Used for HF communications.
- Used for particular sort of TV receptions.
- Used for all round monitoring in higher frequency bands.

Different Types of Antennas

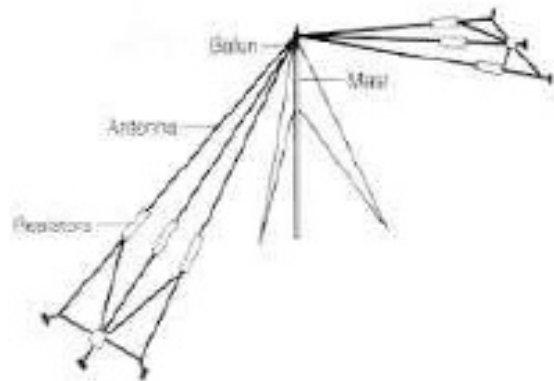

Wire Antenna

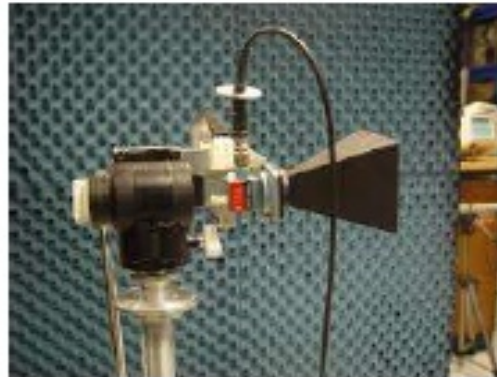

Aperture Antenna



Microstrip Antenna



Array Antenna



Reflector Antenna



Lens Antenna

Microstrip Patch Antenna

- Microstrip Antenna was **Invented by Bob Munson in 1972** .
- Microstrip antennas are **attractive due to their light weight, conformability and low cost**.
- These antennas can be **integrated with printed strip-line feed networks and active devices**. This is a relatively **new area of antenna engineering**.
- The radiation properties of micro strip structures have been known since the mid 1950's.
- A Microstrip Patch antenna **consists of a radiating patch on one side of a dielectric substrate which has a ground plane on the other side**.
- The patch is generally **made of conducting material such as copper or gold and can take any possible shape**.
- The radiating patch and the feed lines are **usually photo etched on the dielectric substrate**.

Basic Structure Microstrip patch Antenna

L = Length of the Micro-strip Patch Element

W = Width of the Micro-strip Patch Element

t = Thickness of Patch

h = Height of the Dielectric Substrate.

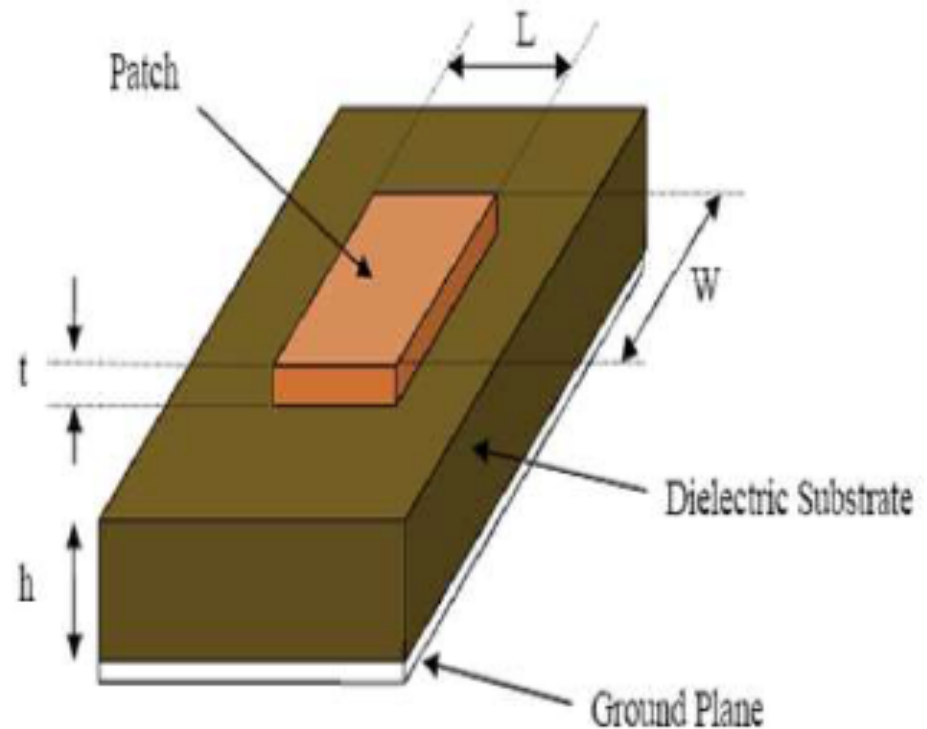

Microstrip Rectangular Patch Antenna

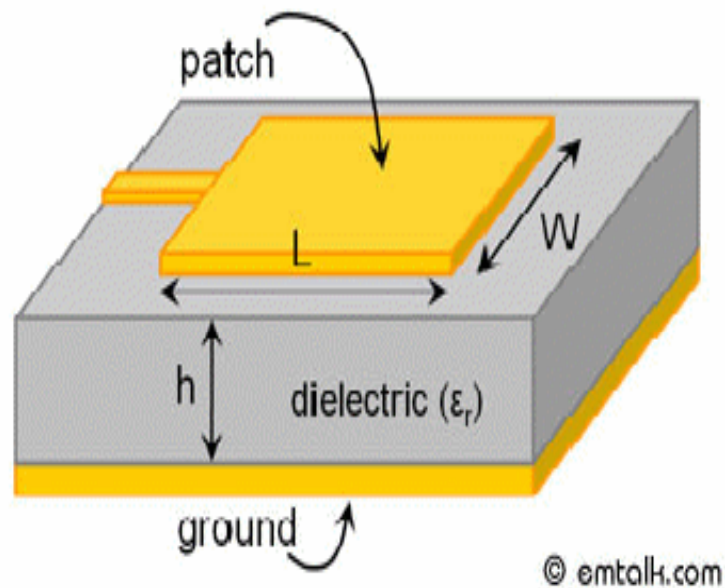

$$W = \frac{v_o}{2f_r} \sqrt{\frac{2}{\epsilon_r + 1}}$$

$$L = \frac{v_o}{2f_r \sqrt{\epsilon_{\text{reff}}}} - 2\Delta L$$

$$\epsilon_{\text{reff}} = \frac{\epsilon_r + 1}{2} + \frac{\epsilon_r - 1}{2} \left[1 + 12 \frac{h}{W} \right]^{-1/2}$$

$$\Delta L = 0.412h \frac{(\epsilon_{\text{reff}} + 0.3)(Wh + 0.264)}{(\epsilon_{\text{reff}} - 0.258)(Wh + 0.8)}$$

TOP VIEW OF PATCH

$$\epsilon_{eff} = \frac{\epsilon_r + 1}{2} + \frac{\epsilon_r - 1}{2} \left(\frac{1}{\sqrt{1 + \frac{12h}{W}}} \right)$$

Length of metallic patch (L)

$$L = L_{eff} - 2\Delta L$$

Where

$$L_{eff} = \frac{C}{2f_r \sqrt{\epsilon_{eff}}}$$

B. Calculation of Length Extension

$$\frac{\Delta L}{h} = 0.412 \frac{(\epsilon_{eff} + 0.3) \left(\frac{W}{h} + 0.264 \right)}{(\epsilon_{eff} - 0.258) \left(\frac{W}{h} + 0.8 \right)}$$

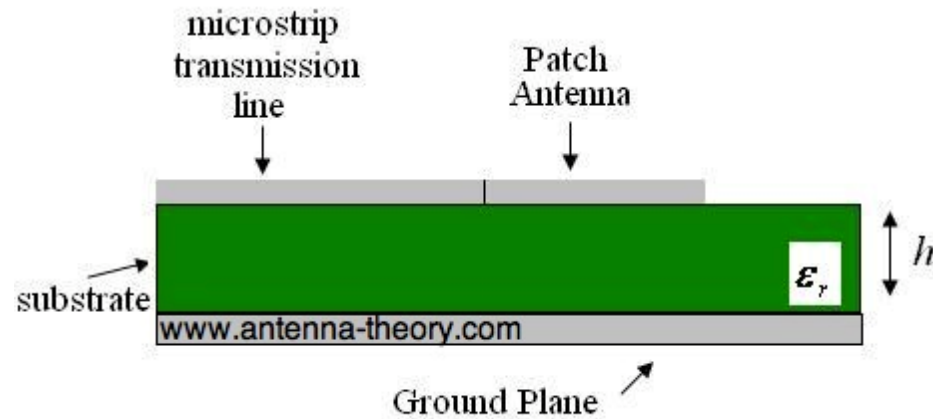

SIDE VIEW OF PATCH

Some of the Typical Shapes of Patch



Rectangular



Square



Circular



Circular ring



Elliptical



Triangular

Substrate Material(FR4 Epoxy)

- The Dielectric Substrate Material we are using in our Design is FR4 Epoxy
- Where “FR” means **Flame Retardant** and **type 4** indicates Woven Glass reinforced Epoxy resin.
- The Range of the dielectric constant of FR4 Epoxy typically depends on glass resin.
- This material is popular and cost effective Compared to other PCB material.
- FR4 is most Commonly Used as an electrical insulator possessing considerable mechanical Strength.
- FR4 is also used in the construction of relays, switches, standoffs, busbars, washers, transformer and screw terminal strips.

- The thickness of the ground plane or of the microstrip is not critically important.
- Typically the height h is much smaller than the wavelength of operation, but should not be much smaller than 0.025 of a wavelength (1/40th of a wavelength) or the antenna efficiency will be degraded.
- The width W of the microstrip antenna controls the input impedance.
- Larger widths also can increase the bandwidth.

- The frequency of operation of the patch antenna is determined by the length L . The center frequency will be approximately given by:

$$f_c \approx \frac{c}{2L\sqrt{\epsilon_r}} = \frac{1}{2L\sqrt{\epsilon_0\epsilon_r\mu_0}}$$

- the input impedance will be on the order of 300 Ohms. By increasing the width, the impedance can be reduced.
- However, to decrease the input impedance to 50 Ohms often requires a very wide patch antenna, which takes up a lot of valuable space.
- The width further controls the radiation pattern.

$$E_{\theta} = \frac{\sin\left(\frac{kW \sin \theta \sin \phi}{2}\right)}{\frac{kW \sin \theta \sin \phi}{2}} \cos\left(\frac{kL}{2} \sin \theta \cos \phi\right) \cos \phi$$

$$E_{\phi} = -\frac{\sin\left(\frac{kW \sin \theta \sin \phi}{2}\right)}{\frac{kW \sin \theta \sin \phi}{2}} \cos\left(\frac{kL}{2} \sin \theta \cos \phi\right) \cos \theta \sin \phi$$

- this transmission line **cannot support** pure Transverse Electric-magnetic (**TEM**) mode of transmission, since phase velocities would be different in the air and the substrate.
- Instead, the dominant mode of propagation would be the **Quasi-TEM mode**.

Fringing Fields for Microstrip Antennas

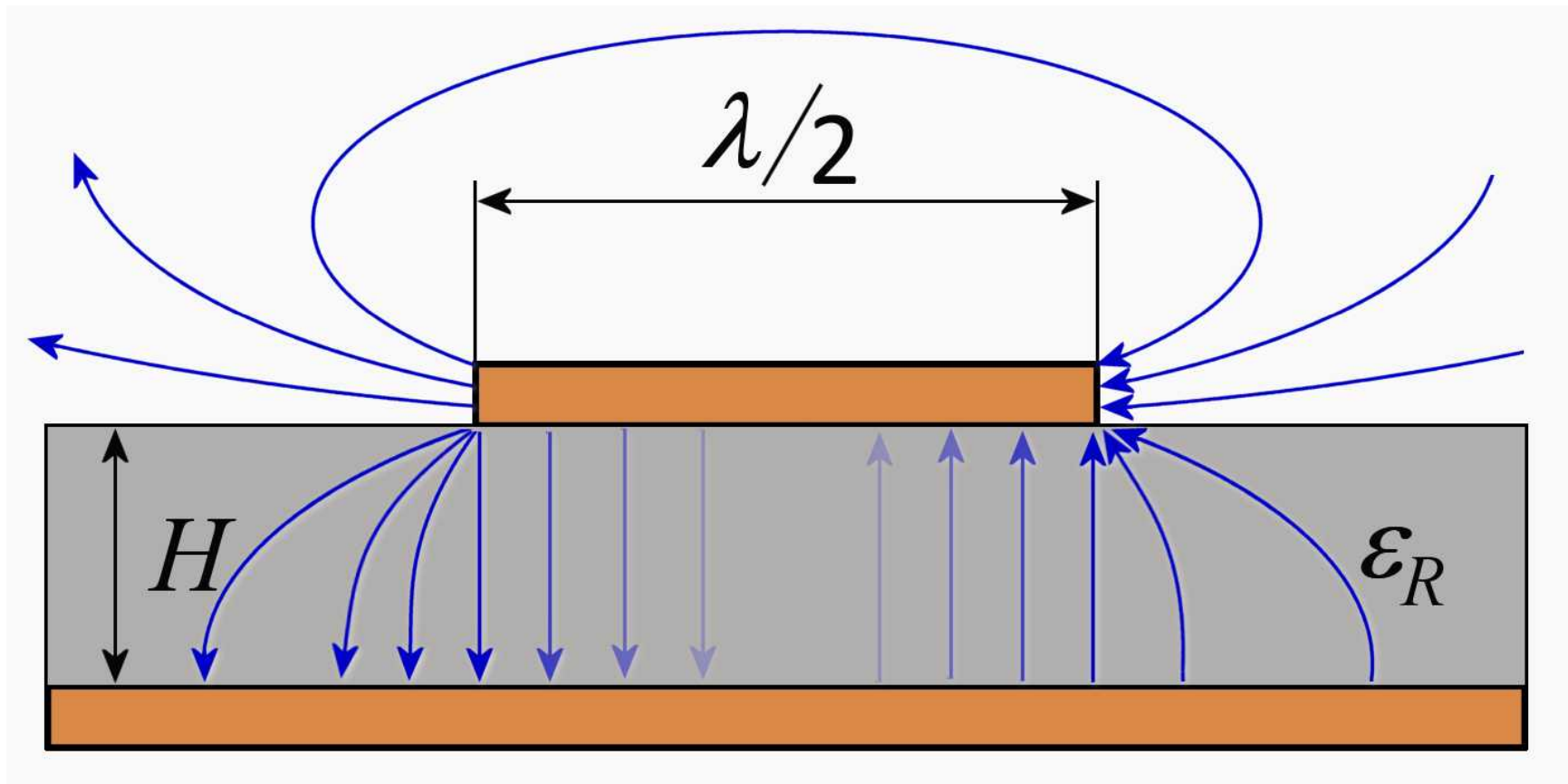

Microstrip Antenna Resonates at

X-Band	8-12GHz
Ku-Band	12-18GHz
K-Band	18-26GHz
Ka-Band	26-40GHz

Advantages and Disadvantages of MSA

Sr. No.	Advantage	Disadvantage
1.	Low weight	Low efficiency
2.	Low profile	Low gain
3.	Thin profile	Large ohmic loss in the feed structure of arrays
4.	Required no cavity backing	Low power handling capacity
5.	Linear and circulation polarization	Excitation of surface waves
6.	Capable of dual and triple frequency operation	Polarization purity is difficult to achieve
7.	Feed lines and matching network can be fabricated simultaneously	Complex feed structures require high performance arrays

Application of MSA



Mobile and satellite communication System

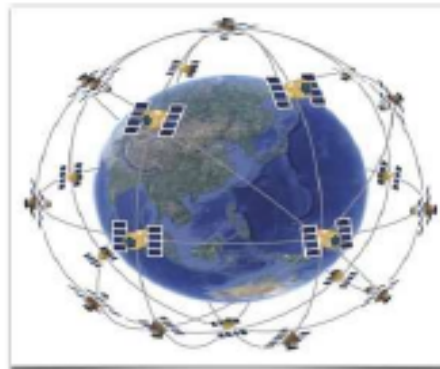

Global Positioning System(GPS)



Direct Broad Cast Television(DBS)



Radio Frequency Identification (RFID)



Worldwide Interoperability for Microwave Access (WiMax)

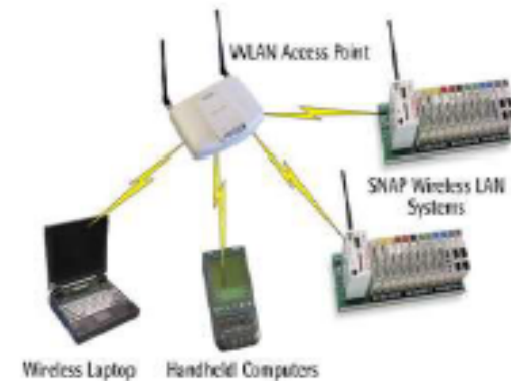

Wireless LAN's

Planar Inverted F-Antenna (PIFA)

- Increasingly used in the mobile phone market.
- The antenna is resonant at a quarter-wavelength (thus reducing the required space needed on the phone),
- and also typically has good SAR properties.
- This antenna resembles an inverted F, which explains the PIFA name.
- The Planar Inverted-F Antenna is popular because it has a low profile and an omnidirectional pattern.

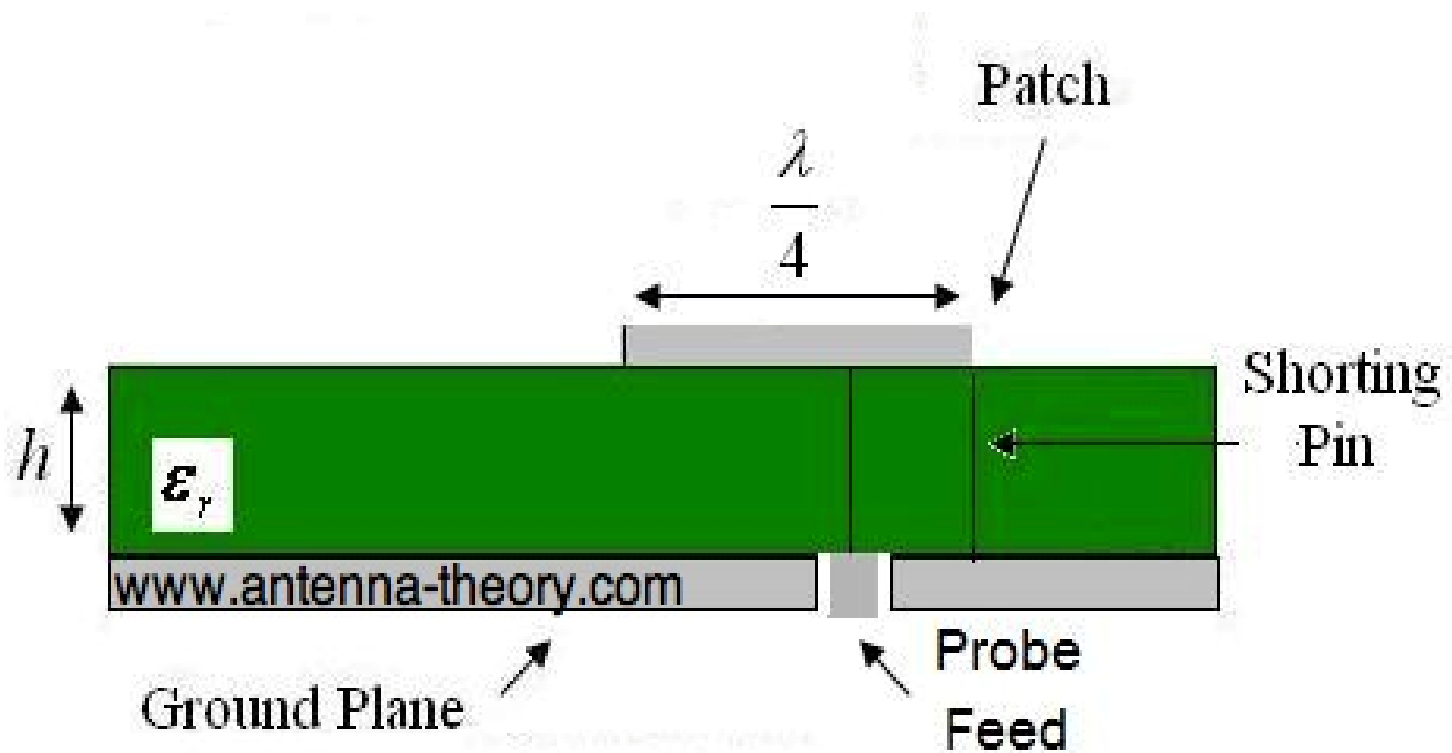

Specific Absorption Rate

- measure of how transmitted RF energy is absorbed by human tissue. SAR is a function of the electrical conductivity, the induced E-field from the radiated energy and the mass density of the tissue.
- The SAR is calculated by averaging (or integrating) over a specific volume (typically a 1 gram or 10 gram area)
- The units of SAR are W/kg, or equivalently, mW/g.

The antenna types and locations on the Samsung Galaxy S

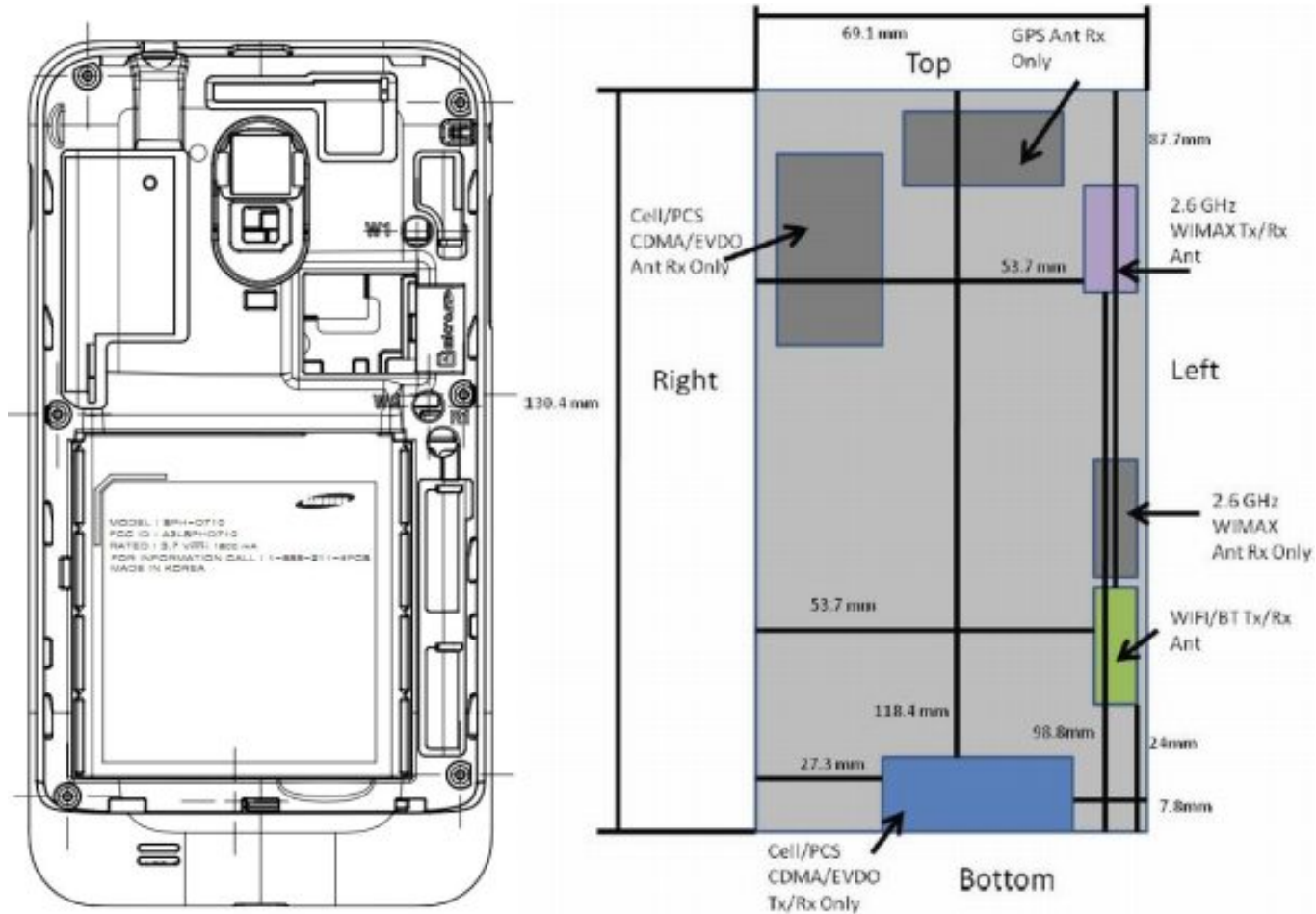

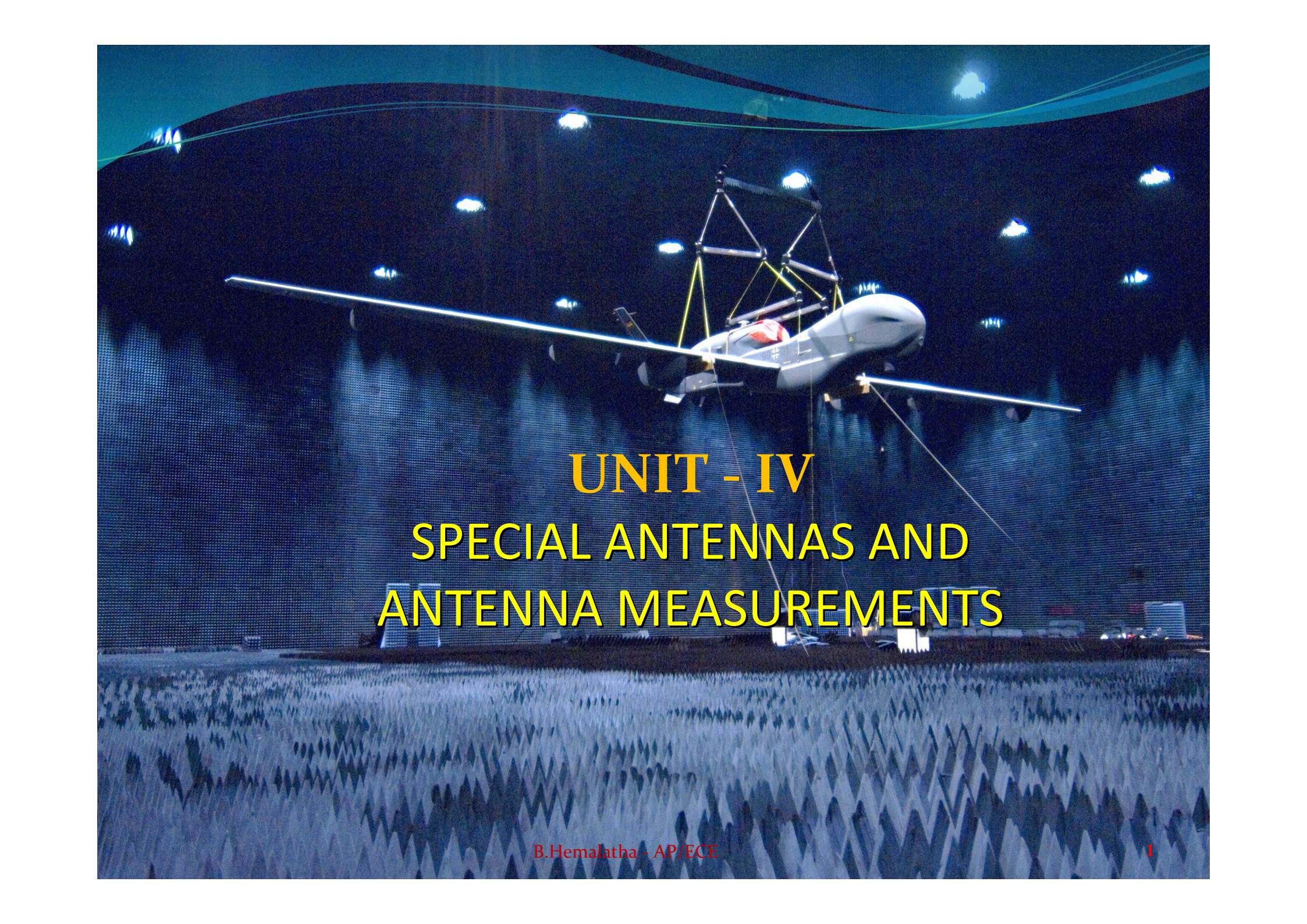

UNIT - IV
SPECIAL ANTENNAS AND
ANTENNA MEASUREMENTS

Elementary Antennas

low cost – flexible solutions

Long Wire Antenna

- effective wideband antenna
- length $l =$ several wavelengths
 - used for signals with $0.1l < \lambda < 0.5l$
 - frequency span = 5:1
- drawback for band limited systems - unavoidable interference
- near end driven by ungrounded transmitter output
- far end terminated by resistor
 - typically several hundred Ω
 - impedance matched to antenna Z_0
- transmitter electrical circuit ground connected to earth
- practically - long wire is a lossy transmission line
 - terminating resistor prevent standing waves

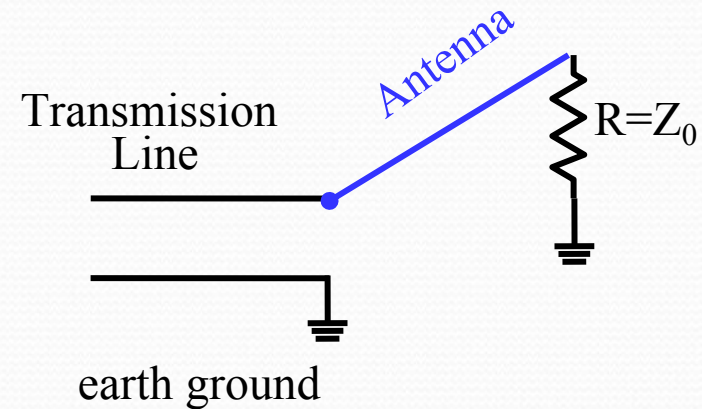

Polar radiation pattern

- 2 main lobes
 - on either side of antenna
 - pointed towards antenna termination
- smaller lobes on each side of antenna – pointing forward & back
- radiation angle 45° (depending on height) → useful for sky waves

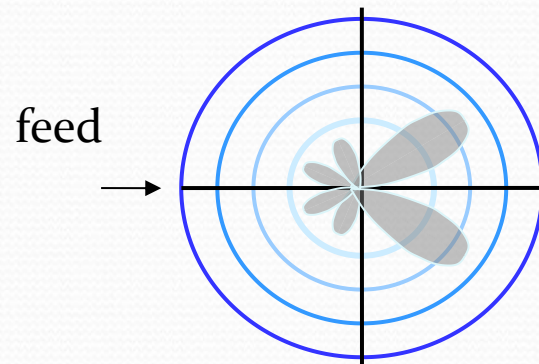

Polar radiation pattern

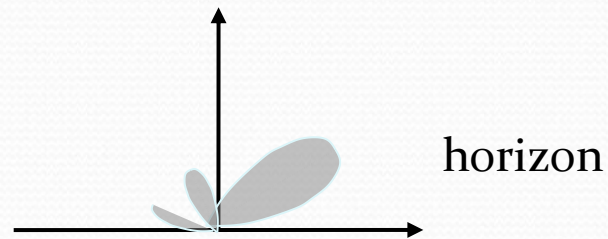

Angular radiation pattern

Poor Efficiency:

Transmit power

- 50% of transmit power radiated
- 50% dissipated in termination resistor

Receive power

- 50% captured EM energy converted to signal for receiver
- 50% absorbed by terminating resistor

TYPES OF ANTENNAS

- According to their applications and technology available, antennas generally fall in one of two categories:
 1. Omnidirectional or only weakly directional antennas which receive or radiate more or less in all directions. These are employed when the relative position of the other station is unknown or arbitrary. They are also used at lower frequencies where a directional antenna would be too large, or simply to cut costs in applications where a directional antenna isn't required.
 2. Directional or *beam* antennas which are intended to preferentially radiate or receive in a particular direction or directional pattern.

- According to length of transmission lines available, antennas generally fall in one of two categories:

1. Resonant Antennas – is a transmission line, the length of which is exactly equal to multiples of half wavelength and it is open at both ends.

2. Non-resonant Antennas – the length of these antennas is not equal to exact multiples of half wavelength. In these antennas standing waves are not present as antennas are terminated in correct impedance which avoid reflections. The waves travel only in forward direction .Non-resonant antenna is a unidirectional antenna.

RADIATION PATTERN

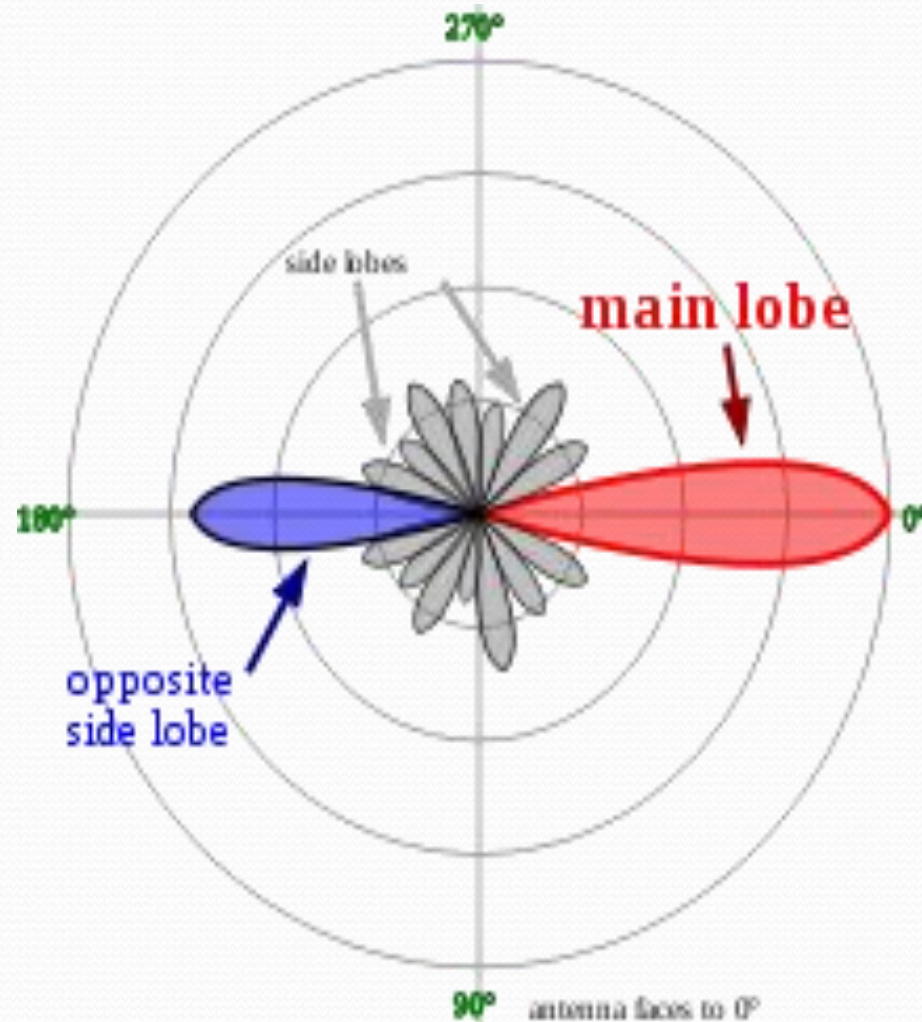

- The radiation pattern of an antenna is a plot of the relative field strength of the radio waves emitted by the antenna at different angles.
- It is typically represented by a three dimensional graph, or polar plots of the horizontal and vertical cross sections. It is a plot of field strength in V/m versus the angle in degrees.
- The pattern of an ideal isotropic antenna , which radiates equally in all directions, would look like a sphere.
- Many non-directional antennas, such as dipoles, emit equal power in all horizontal directions, with the power dropping off at higher and lower angles; this is called an omni directional pattern and when plotted looks like a donut.

- The radiation of many antennas shows a pattern of maxima or "*lobes*" at various angles, separated by "*nulls*", angles where the radiation falls to zero.
- This is because the radio waves emitted by different parts of the antenna typically interfere, causing maxima at angles where the radio waves arrive at distant points in phase, and zero radiation at other angles where the radio waves arrive out of phase.
- In a directional antenna designed to project radio waves in a particular direction, the lobe in that direction is designed larger than the others and is called the "*main lobe*".
- The other lobes usually represent unwanted radiation and are called "*sidelobes*". The axis through the main lobe is called the "*principle axis*" or "*boresight axis*".

ANTENNA GAIN

- Gain is a parameter which measures the degree of directivity of the antenna's radiation pattern. A high-gain antenna will preferentially radiate in a particular direction.
- Specifically, the *antenna gain*, or *power gain* of an antenna is defined as the ratio of the intensity (power per unit surface) radiated by the antenna in the direction of its maximum output, at an arbitrary distance, divided by the intensity radiated at the same distance by a hypothetical isotropic antenna.

- The gain of an antenna is a passive phenomenon - power is not added by the antenna, but simply redistributed to provide more radiated power in a certain direction than would be transmitted by an isotropic antenna.
- High-gain antennas have the advantage of longer range and better signal quality, but must be aimed carefully in a particular direction.
- Low-gain antennas have shorter range, but the orientation of the antenna is relatively inconsequential.

- For example, a dish antenna on a spacecraft is a high-gain device that must be pointed at the planet to be effective, whereas a typical Wi-Fi antenna in a laptop computer is low-gain, and as long as the base station is within range, the antenna can be in any orientation in space.
- In practice, the half-wave dipole is taken as a reference instead of the isotropic radiator. The gain is then given in **dBd** (decibels over dipole)

ANTENNA EFFICIENCY

- Efficiency of a transmitting antenna is the ratio of power actually radiated (in all directions) to the power absorbed by the antenna terminals.
- The power supplied to the antenna terminals which is not radiated is converted into heat. This is usually through loss resistance in the antenna's conductors, but can also be due to dielectric or magnetic core losses in antennas (or antenna systems) using such components.

POLARIZATION

- The polarization of an antenna is the orientation of the electric field (E-plane) of the radio wave with respect to the Earth's surface and is determined by the physical structure of the antenna and by its orientation.
- A simple straight wire antenna will have one polarization when mounted vertically, and a different polarization when mounted horizontally.
- Reflections generally affect polarization. For radio waves the most important reflector is the ionosphere - signals which reflect from it will have their polarization changed
- LF, VLF and MF antennas are vertically polarized

BEAM-WIDTH

- Beam-width of an antenna is defined as angular separation between the two half power points on power density radiation pattern OR
- Angular separation between two 3dB down points on the field strength of radiation pattern
- It is expressed in degrees

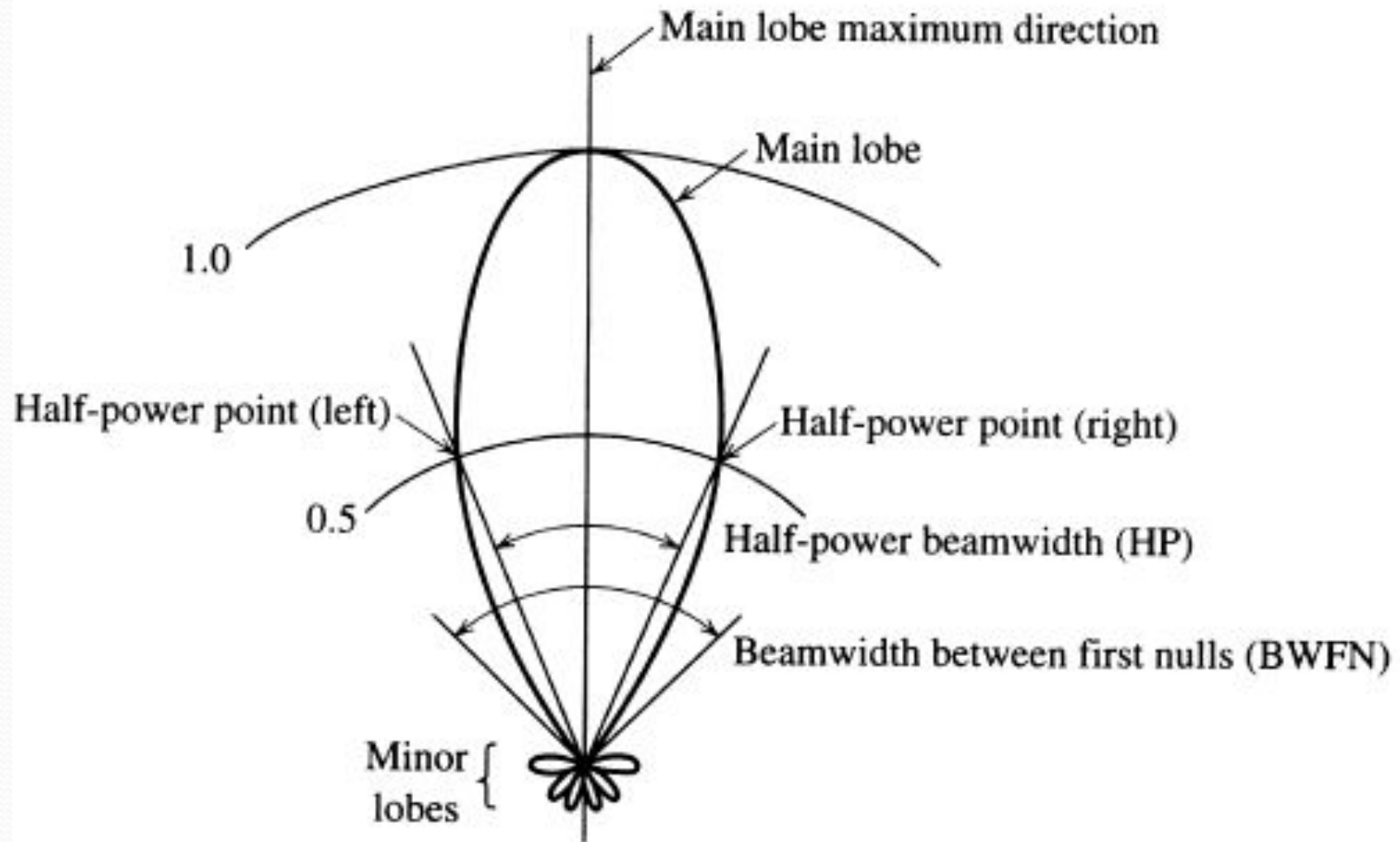

RHOMBIC ANTENNA

- Structure and construction
 - 4 wires are connected in rhombic shape and terminated by a resistor.
 - Mounted horizontally and placed $> \lambda/2$ from ground.
- Highest development of long wire antenna is rhombic antenna.

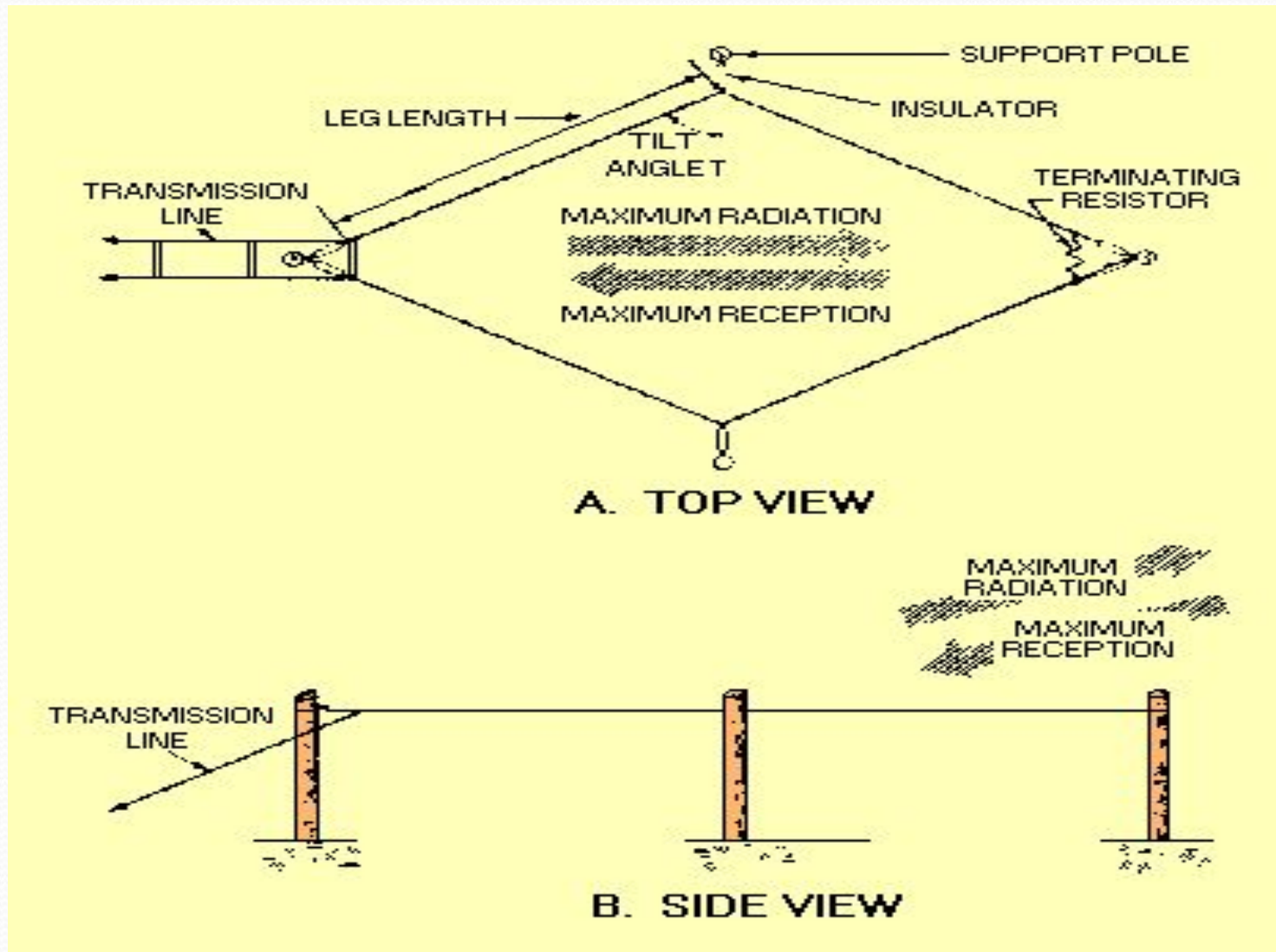

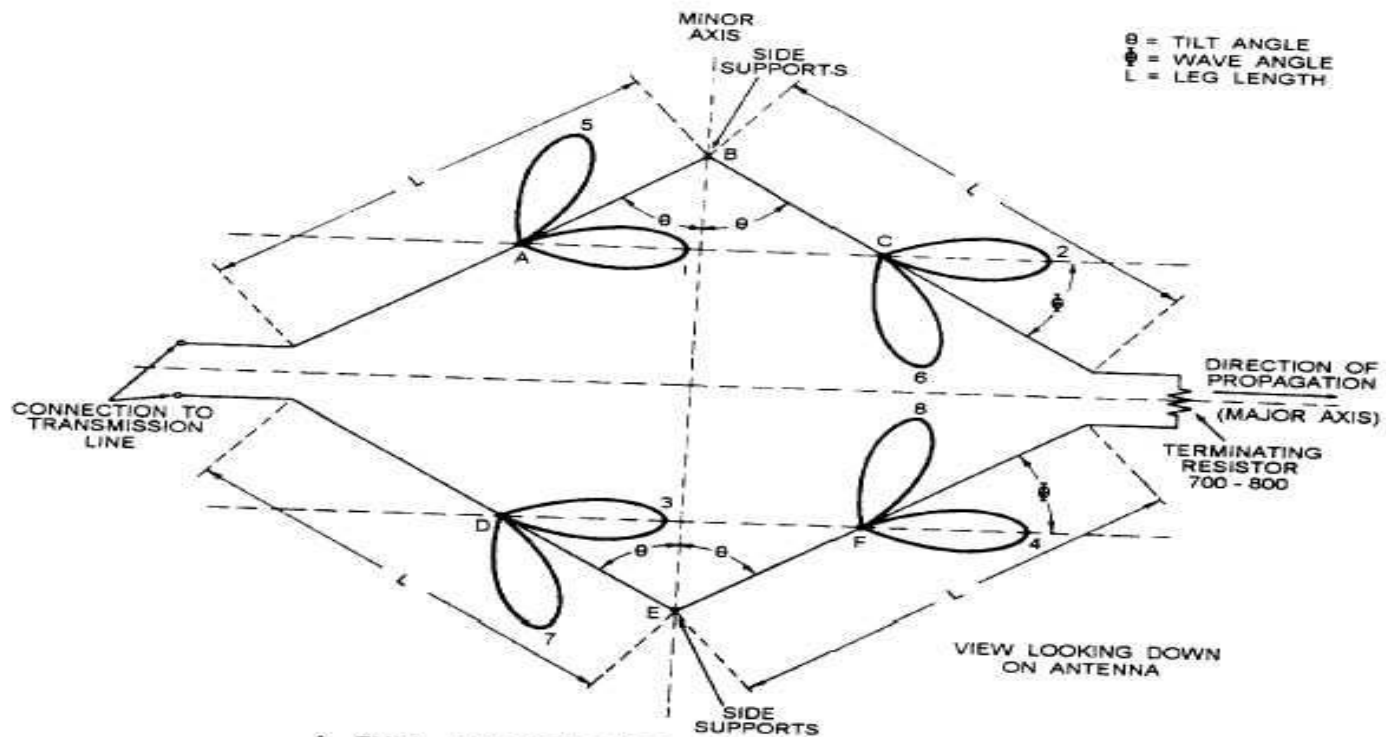

A. FULL - RHOMBIC TRANSMITTING ANTENNA

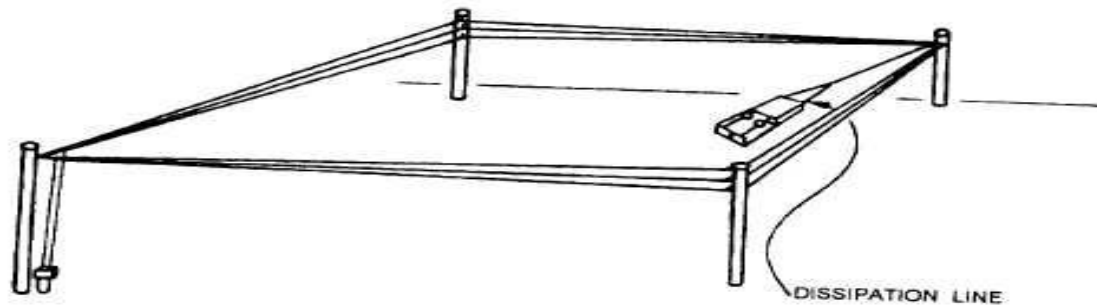

B. NON - RESONANT HORIZONTAL THREE - WIRE RHOMBIC

35NP0013



- **Advantages**

- Easier to construct
- Its i/p impedance and radiation pattern are relatively constant over range of frequencies.
- Maximum efficiency
- High gain can be obtained.

- **Disadvantages**

- Large site area and large side lobes.

Application

- Long distance communication, high frequency transmission and reception.
- Point to point communication.
- Radio communication.
- Short wave radio broadcasting.

YAGI-UDA ANTENNA

- It is a directional antenna consisting of a driven element (typically a dipole or folded dipole) and additional parasitic elements (usually a so-called *reflector* and one or more *directors*).
- All the elements are arranged collinearly and close together.
- The reflector element is slightly longer (typically 5% longer) than the driven dipole, whereas the so-called directors are a little bit shorter.
- The design achieves a very substantial increase in the antenna's directionality and gain compared to a simple dipole.

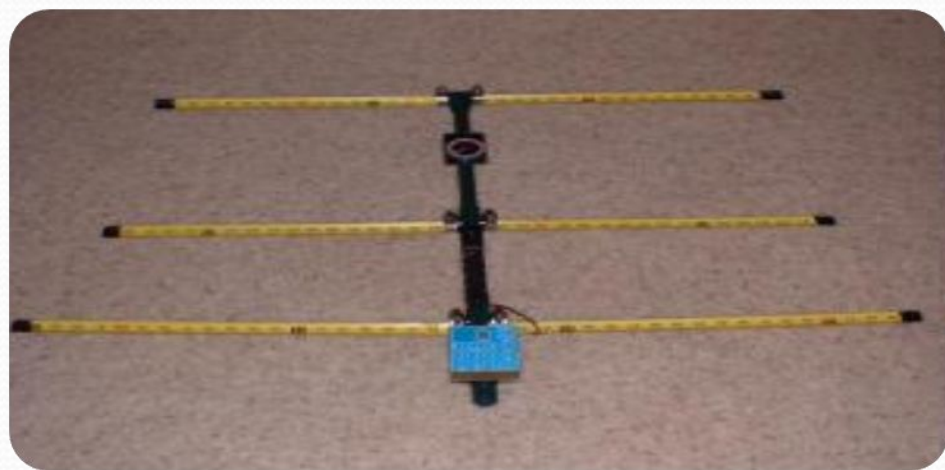
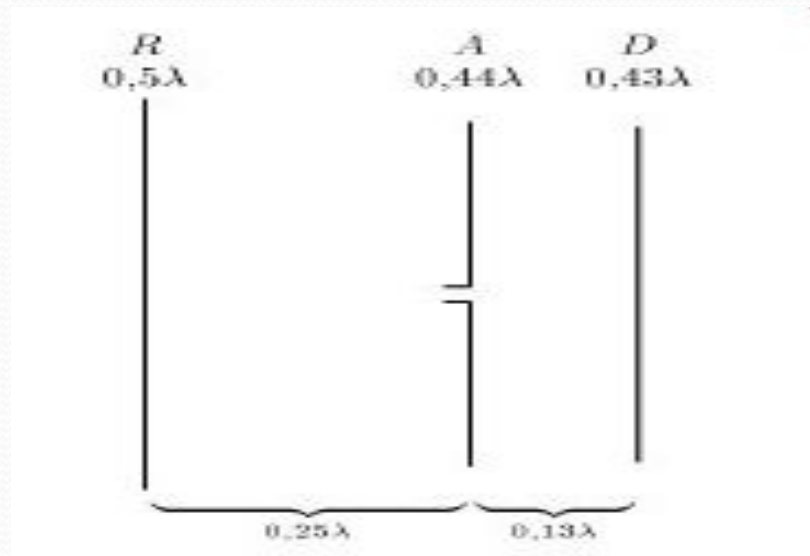

- Typical spacing between elements vary from about $1/10$ to $1/4$ of a wavelength, depending on the specific design.
- The elements are usually parallel in one plane.
- Radiation pattern is modified figure of eight
- By adjusting distance between adjacent directors it is possible to reduce back lobe
- Improved front to back ratio

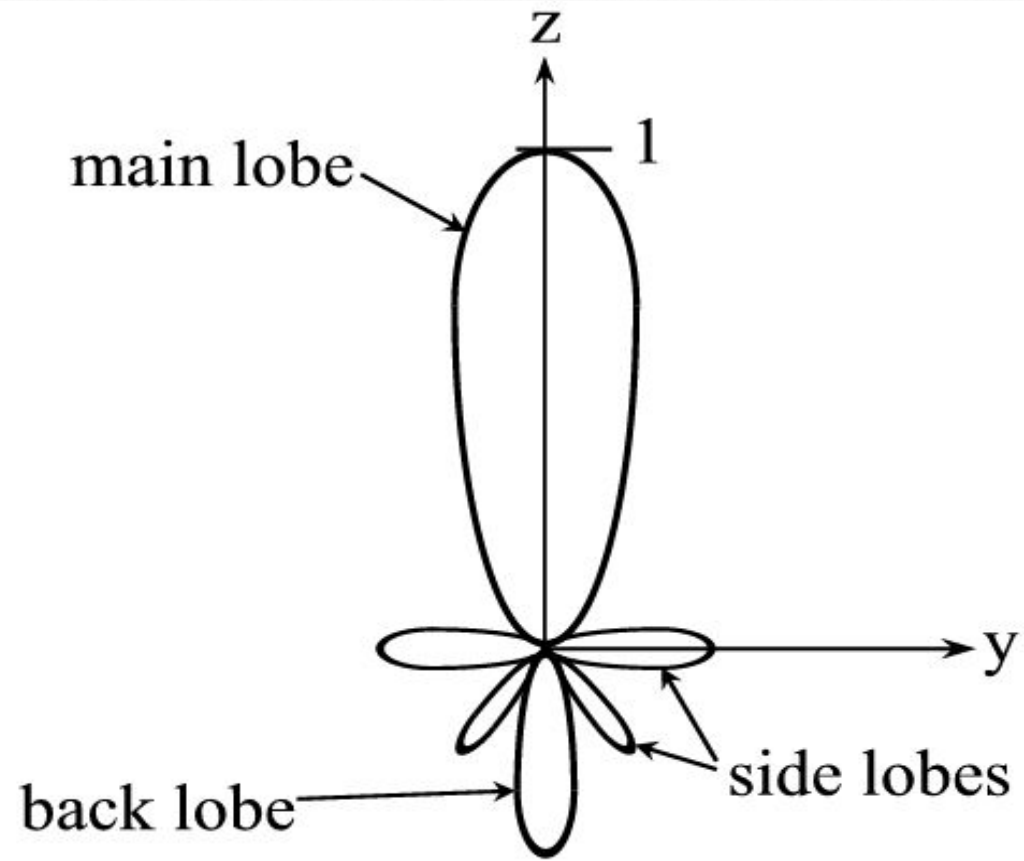

(a)

ANTENNA APPLICATIONS

They are used in systems such as

- Radio broadcasting
- Broadcast television
- Two-way radio
- Communication receivers
- Radar
- Cell phones
- Satellite communications.

ANTENNA CONSIDERATIONS

- The space available for an antenna
- The proximity to neighbors
- The operating frequencies
- The output power
- Money

LOOP ANTENNA

- A **loop antenna** is a radio antenna consisting of a loop of wire with its ends connected to a balanced transmission line
- It is a single turn coil carrying RF current through it.
- The dimensions of coil are smaller than the wavelength hence current flowing through the coil has same phase.
- Small loops have a poor efficiency and are mainly used as receiving antennas at low frequencies. Except for car radios, almost every AM broadcast receiver sold has such an antenna built inside of it or directly attached to it.

- A technically small loop, also known as a magnetic loop, should have a circumference of one tenth of a wavelength or less. This is necessary to ensure a constant current distribution round the loop.
- As the frequency or the size are increased, a standing wave starts to develop in the current, and the antenna starts to have some of the characteristics of a folded dipole antenna or a self-resonant loop.
- Self-resonant loop antennas are larger. They are typically used at higher frequencies, especially VHF and UHF, where their size is manageable. They can be viewed as a form of folded dipole and have somewhat similar characteristics. The radiation efficiency is also high and similar to that of a dipole.

- Radiation pattern of loop antenna is a doughnut pattern.
- Can be circular or square loop
- No radiation is received normal to the plane of loop and null is obtained in this direction.
- Application: Used for direction finding applications



TURNSTILE ANTENNA

- A **turnstile antenna** is a set of two dipole antennas aligned at right angles to each other and fed 90 degrees out-of-phase.
- The name reflects that the antenna looks like a turnstile when mounted horizontally.
- When mounted horizontally the antenna is nearly omnidirectional on the horizontal plane.



FOLDED DIPOLE

- Folded antenna is a single antenna but it consists of two elements.
- First element is fed directly while second one is coupled inductively at its end.
- Radiation pattern of folded dipole is same as that of dipole antenna i.e figure of eight (8).



Advantages

- Input impedance of folded dipole is four times higher than that of straight dipole.
- Typically the input impedance of half wavelength folded dipole antenna is 288 ohm.
- Bandwidth of folded dipole is higher than that of straight dipole.

Biconical Antenna



- Types of Biconical
 - Infinite Biconical
 - Finite Biconical
 - Discone

Log Periodic Antenna

- The antenna is ideally suited for reception of VHF/UHF point-to-point communication where its directional characteristics can significantly improve rejection of interfering signals.
- In professional applications, this antenna is ideally suited for EMC pre-testing, surveillance and monitoring.
- The antenna covers a frequency range of 230 to 1600 MHz (a much wider frequency range can be received with reduced gain).

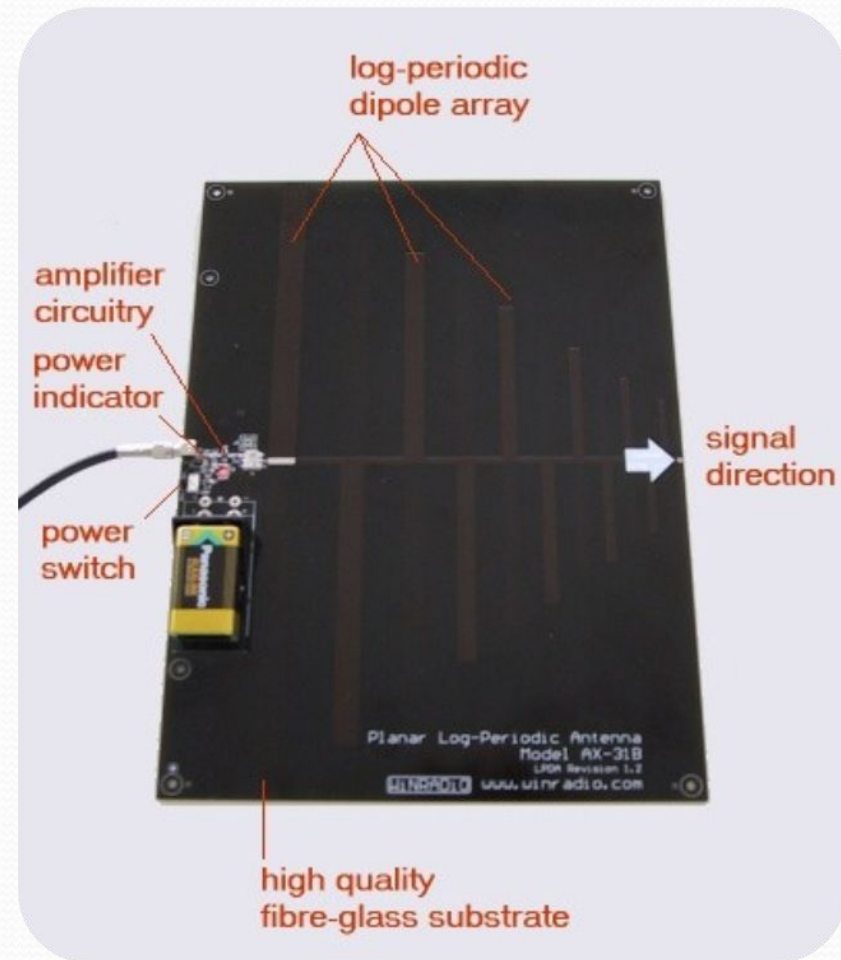

Sleeve Antenna

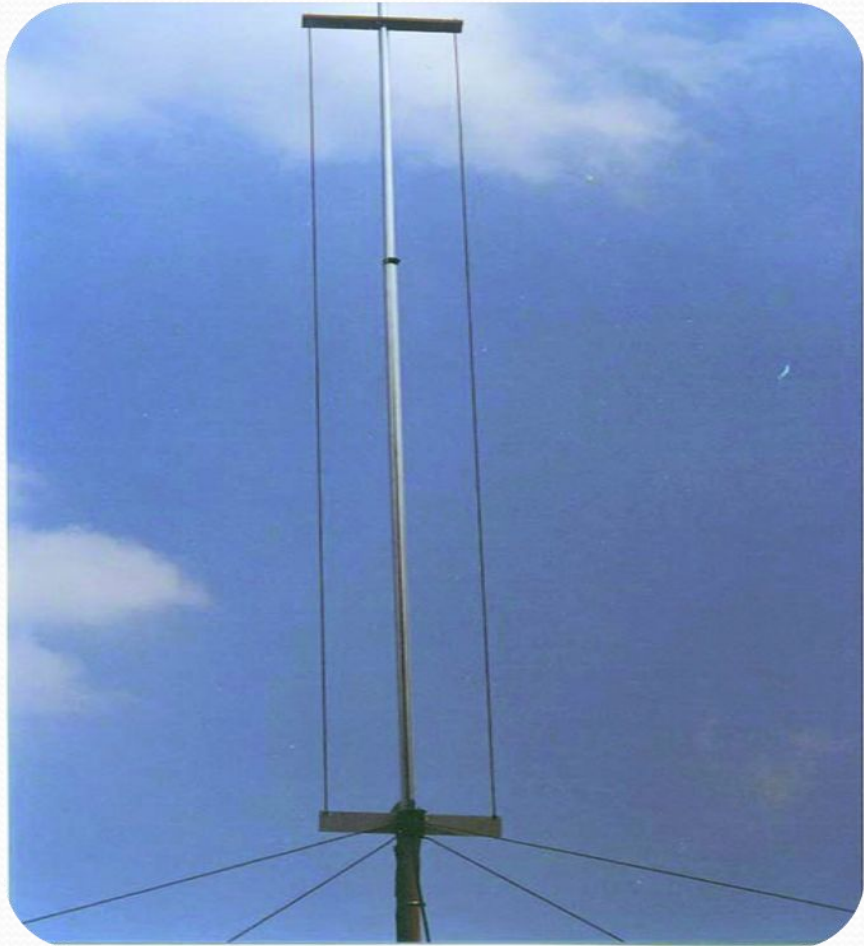

The sleeve antenna is used primarily as a receiving antenna. It is a broadband, vertically polarized, omnidirectional antenna.

Its primary uses are in broadcast, ship-to-shore, and ground-to-air communications.

Although originally developed for shore stations, there is a modified version for shipboard use.

Spiral Antenna



- The spiral antenna is used primarily as a receiving antenna
- Vertically polarized
- Frequency Independent
 - Designed to minimize finite lengths and maximize angular dependence

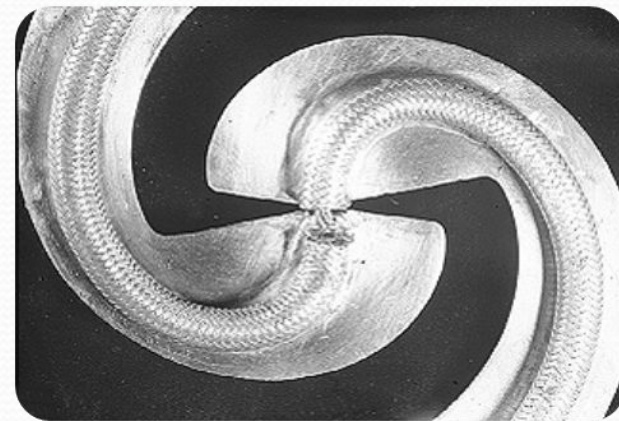

Helical Antenna

- Directional
- Circularly Polarized
 - Polarization changes with time
- Both high gain and wide band

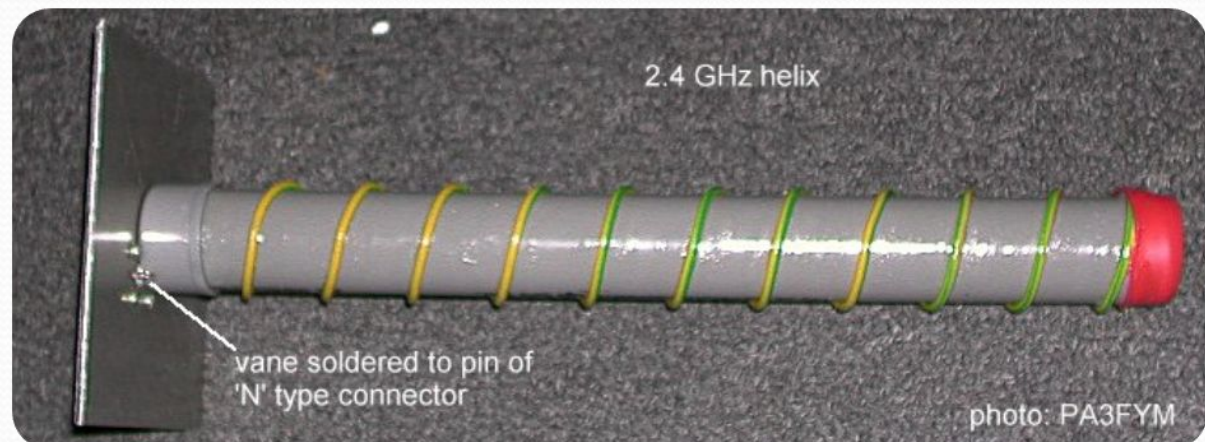

Geometry

D = diameter of helix

C = circumference of helix

L_0 = length of one turn = $\sqrt{C^2 + S^2}$

α = pitch angle = $\tan^{-1}\left(\frac{S}{\pi D}\right)$

S = spacing between turns

N = number of turns

L_w = length of helix

d = diameter of conductor

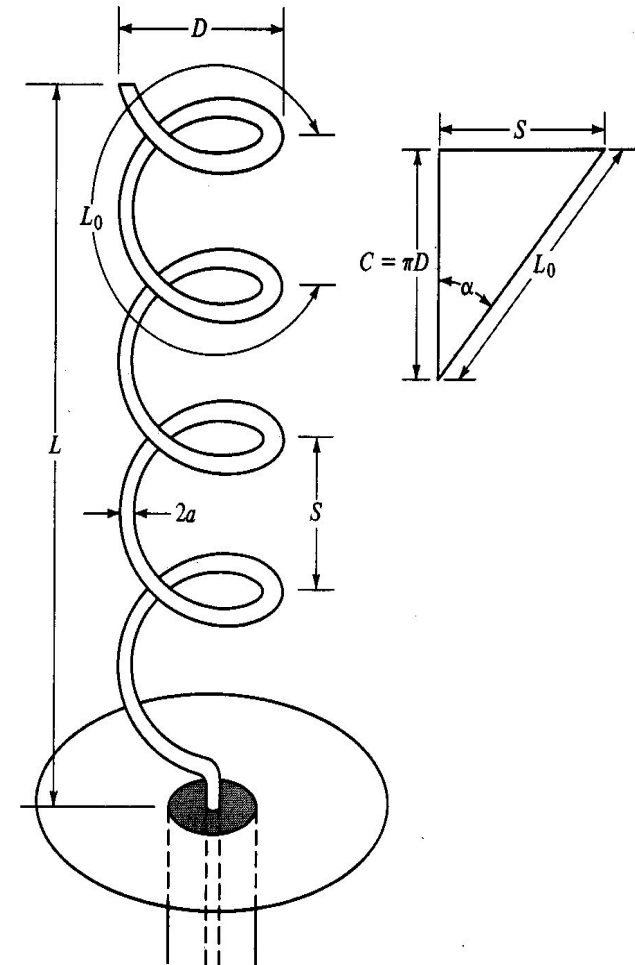
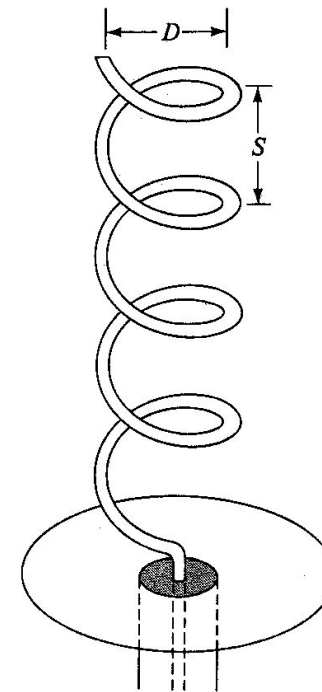
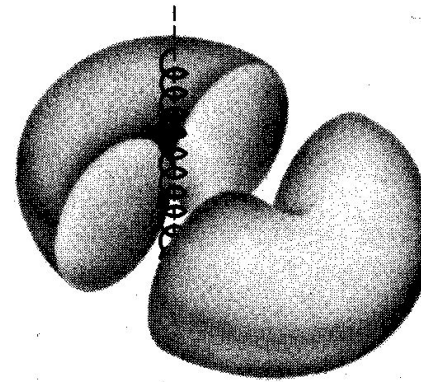

Figure 9.9 Helical antenna with ground plane.

Normal Mode

- Radiation pattern similar to linear dipole
- The dimensions of the helix are small compared to the wavelength
- Narrow in bandwidth
- Radiation efficiency is small
- Rarely used



(a) Normal mode

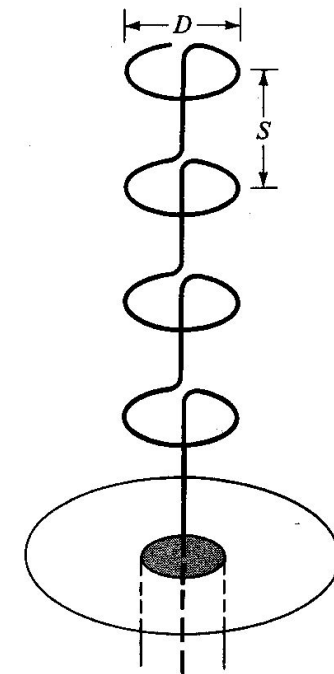

(b) Equivalent

Axial Mode

- Circular Polarization
 - $\frac{3}{4} < C/\lambda < 4/3$
 - $C/\lambda = 1$: near optimum
 - $S = \lambda/4$
- Half-Power Beam width: 50 x 50 degrees

$$\frac{52\lambda^{3/2}}{C\sqrt{NS}}$$

- Directivity:

$$15N \frac{C^2 S}{\lambda^3}$$

- Typical Gain: 10dB
- Bandwidth: 52%
- Frequency limit: 100MHz to 3GHz

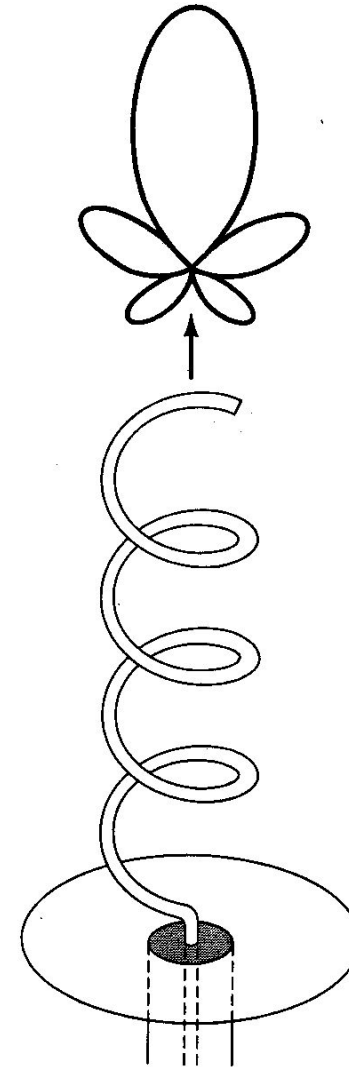
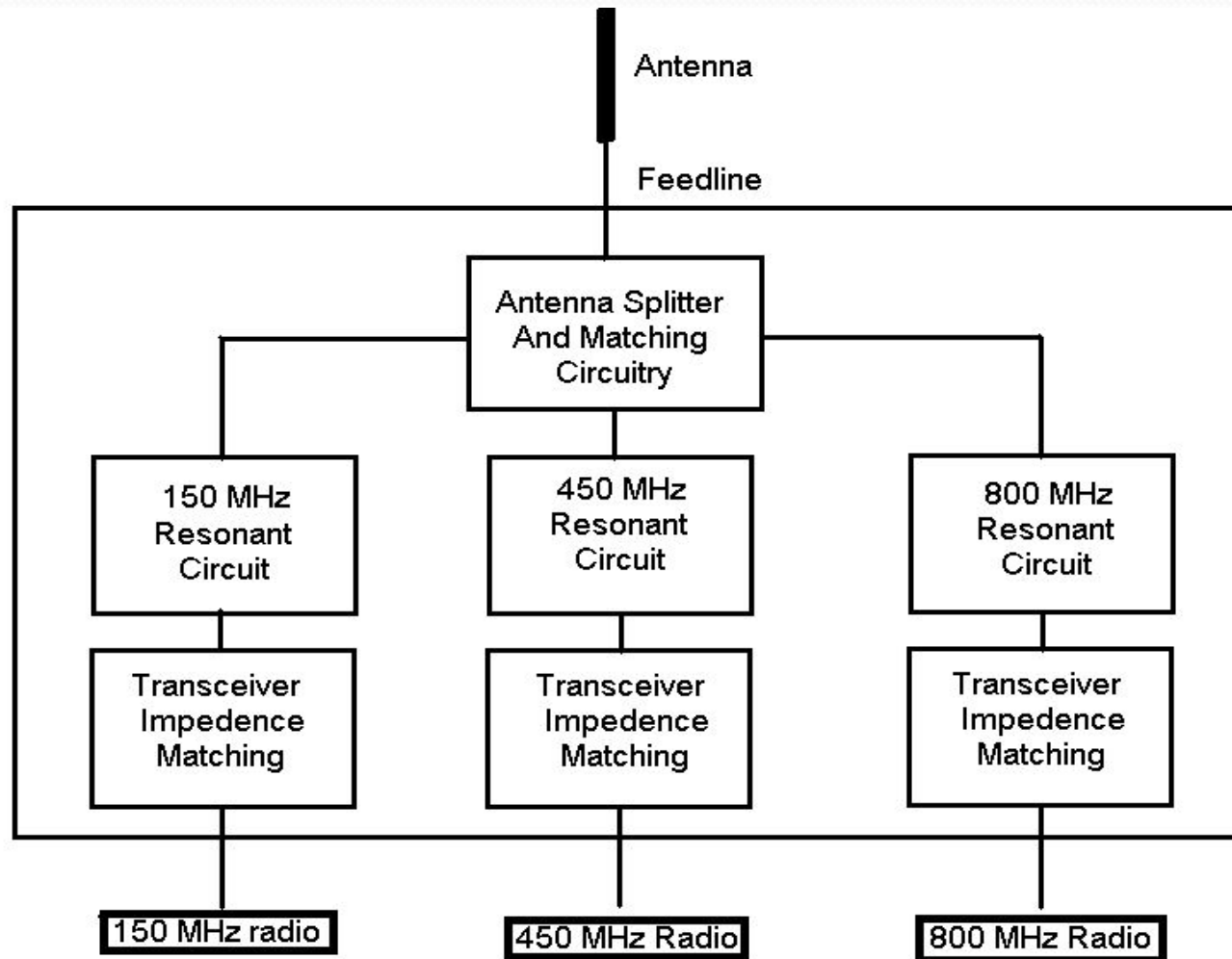

Figure 9.11 Axial (endfire) mode of helix.

Helix Applications

- Space Telemetry Applications of satellites, space probes, and ballistic missiles
 - Signals have undergone Faraday rotation
- Directional applications

Adaptation of Single Antenna for Multi-band Use.



Antenna Characterization

- antennas generate **EM field pattern**
- not always possible to model mathematically
- difficult to account for obstacles
- antennas are studied in EM **isolated rooms** to extract key performance characteristics

antenna design & relative **signal intensity** determines **relative field pattern**

absolute value of **signal intensity** varies for given antenna design

- at the transmitter this is related to power applied at transmitter
- at the receiver this is related to power in surrounding space

Polar Plot of relative signal strength of radiated field

- shows how field strength is shaped
- generally 0° aligned with major physical axis of antenna
- most plots are relative scale (dB)
 - maximum signal strength location is 0 dB reference
 - closer to center represents weaker signals

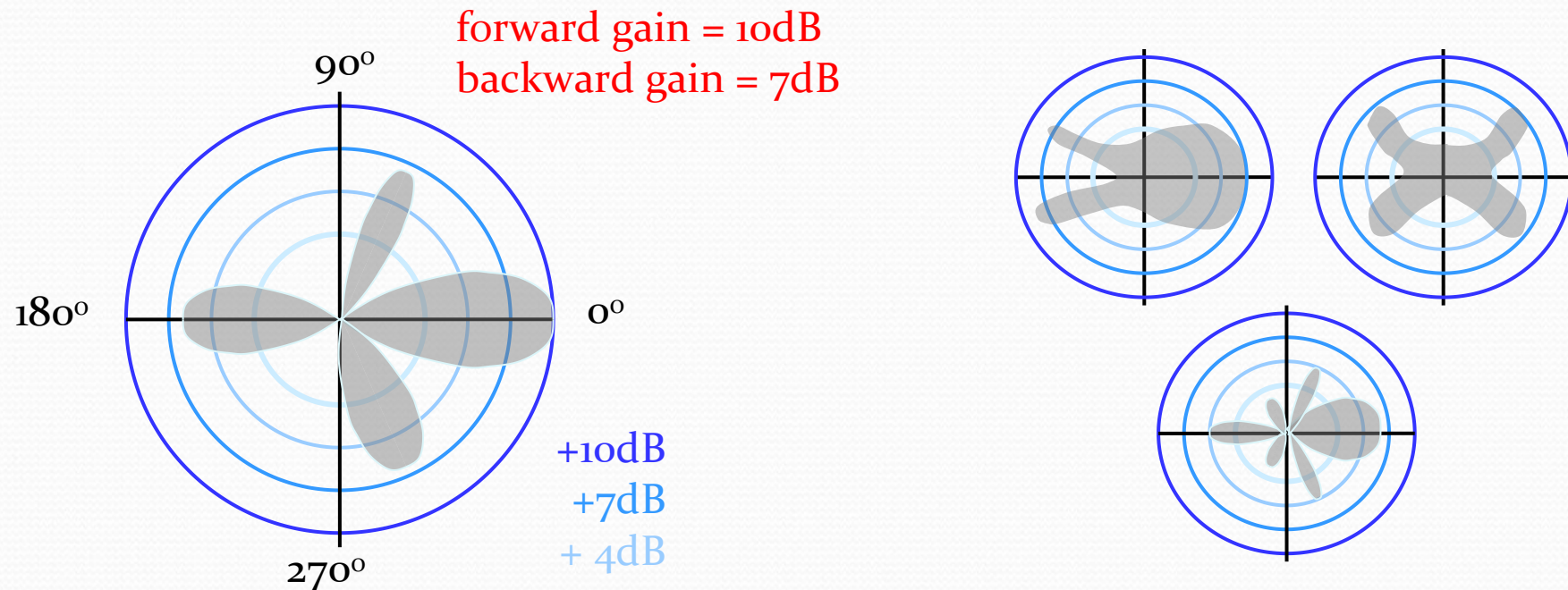

radiated field shaping \approx lens & visible light

- application determines required **direction** & **focus** of signal
- antenna characteristics
 - (i) radiation field pattern
 - (ii) gain
 - (iii) lobes, beamwidth, nulls
 - (iv) directivity

(i) antenna field pattern = general shape of signal intensity in *far-field*

far-field measurements measured many wavelengths away from antenna

near-field measurement involves complex interactions of decaying electrical and magnetic fields - many details of antenna construction

Measuring Antenna Field Pattern

field strength meter used to measure field pattern

- indicates amplitude of received signal
- calibrated to receiving antenna
- relationship between meter and receive antenna known
measured strength in $\mu\text{V}/\text{meter}$
received power is in $\mu\text{W}/\text{meter}$
- directly indicates EM field strength

Determination of overall Antenna Field Pattern

from Radiation Polar Plot Pattern

- use nominal field strength value (e.g. $100\mu\text{V}/\text{m}$)
- measure points for 360° around antenna
- record distance & angle from antenna
- connect points of equal field strength

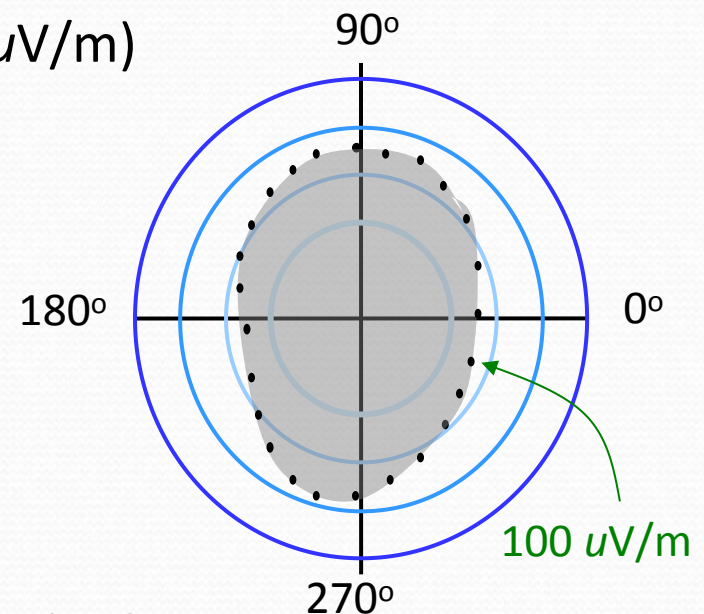

Practically

- distance between meter & antenna kept constant
- antenna is rotated
- plot of field strength versus angle is made

Why Shape the Antenna Field Pattern ?

- transmit antennas: produce higher effective power in **direction** of intended receiver
- receive antennas: concentrate **energy collecting** ability in direction of transmitter
 - **reduced noise** levels - receiver only picks up intended signal
- avoid unwanted receivers (multiple access interference = **MAI**):
 - security
 - multi-access systems
- **locate** target direction & distance – e.g. radar

not always necessary to shape field pattern, standard broadcast is often omnidirectional - 360°

Antenna Gain

Gain is Measured Specific to a **Reference Antenna**

- **isotropic antenna** often used - *gain over isotropic*
 - isotropic antenna – radiates power ideally in all directions
 - gain measured in **dBi**
 - test antenna's field strength relative to reference isotropic antenna
 - at same *power, distance, and angle*
 - isotropic antenna cannot be practically realized

- **½ wave dipole** often used as reference antenna
 - easy to build
 - simple field pattern

Antenna Gain \neq Amplifier Gain

- antenna power output = power input – transmission line loss
- antenna shapes radiated field pattern
- **power measured** at a point is greater/less than that using **reference antenna**
- **total power output doesn't increase**
- power output in given direction increases/decreases relative to reference antenna

e.g.

a lamp is similar to an isotropic antenna

a lens is similar to a directional antenna

- provides a gain/loss of visible light in a specific direction
- doesn't change actual power radiated by lamp

- **transmit antenna** with 6dB gain in specific direction over isotropic antenna → 4× transmit power in that direction
- **receive antenna** with 3dB gain in some direction receives 2× as much power than reference antenna

Antenna Gain

often a cost effective means to

- (i) increase effective transmit power
- (ii) effectively improve receiver sensitivity

may be only technically viable means

- more power may not be available (batteries)
- front end noise determines maximum receiver sensitivity

Rotational Antennas can vary direction of antenna gain

Directional Antennas focus antenna gain in primary direction

Beamwidth, Lobes & Nulls

Lobe: area of high signal strength

- main lobe
- secondary lobes

Nulls: area of very low signal strength

Beamwidth:

- Total angle where relative signal power is 3dB below peak value of main lobe
- can range from 1° to 360°

Beamwidth & Lobes indicate sharpness of pattern focus

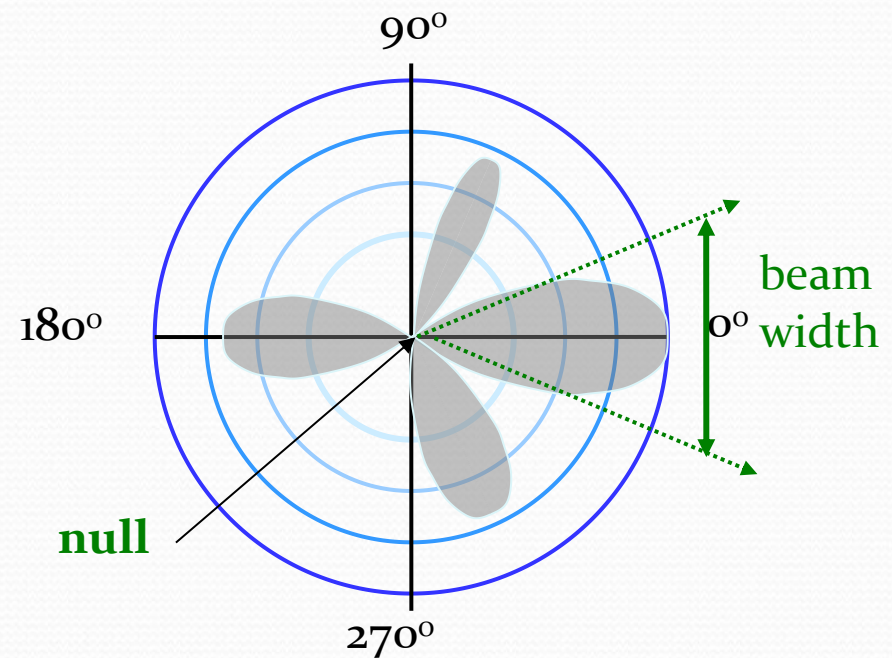

Center Frequency = optimum operating frequency

Antenna Bandwidth \equiv -3dB points of antenna performance

Bandwidth Ratio: Bandwidth/Center Frequency

e.g. $f_c = 100\text{MHz}$ with 10MHz bandwidth

- radiated power at 95MHz & 105MHz = $\frac{1}{2}$ radiated power at f_c
- bandwidth ratio = $10/100 = 10\%$

Antenna Design Basics

Main Trade-offs for Antenna Design

- directivity & beam width
- acceptable lobes
- maximum gain
- bandwidth
- radiation angle

Bandwidth Issues

High Bandwidth Antennas tend to have less gain than narrowband antennas

Narrowband Receive Antenna reduces interference from adjacent signals & reduce received noise power

Antenna Dimensions

- operating frequencies determine physical size of antenna elements
- design often uses λ as a variable (e.g. 1.5λ length, 0.25λ spacing)

Testing & Adjusting Transmitter → use antenna's electrical load

- Testing required for
 - proper modulation
 - amplifier operation
 - frequency accuracy
- using actual antenna may cause significant interference
- **dummy antenna used** for transmitter design (not antenna design)
 - same impedance & electrical characteristics
 - dissipates energy vs radiate energy
 - isolates antenna from problem of testing transmitter

Testing Receiver

- test & adjust receiver and transmission line **without antenna**
- use single known signal from RF generator
- follow on test with several signals present
- **verify receiver** operation first → then connect antenna to **verify antenna** operation

Polarization

- EM field has specific orientation of E-field & M field
- Polarization Direction determined by antenna & physical orientation
- Classification of E-field polarization
 - **horizontal polarization** : E-field parallel to horizon
 - **vertical polarization**: E-field vertical to horizon
 - **circular polarization**: constantly rotating

Transmit & Receive Antenna

- must have same Polarization for maximum signal energy induction
- if polarizations aren't same → E-field of radiated signal will try to induce E-field into wire \perp to correct orientation
 - theoretically no induced voltage
 - 📁 practically – small amount of induced voltage

📁 Circular Polarization

- compatible with any polarization field from horizontal to vertical
- maximum gain is 3dB less than correctly oriented horizontal or vertically polarized antenna

Antenna Fundamentals

Dipole Antennas (Hertz): simple, old, widely used
- root of many advance antennas

- consists of 2 spread conductors of 2 wire transmission lines
- each conductor is $\frac{1}{4} \lambda$ in length
- total span = $\frac{1}{2} \lambda$ + small center gap

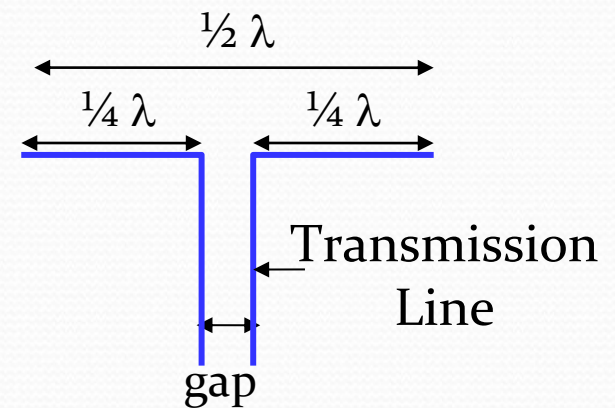

Distinct voltage & current patterns

driven by *transmission line* at midpoint

- $i = 0$ at end, maximum at midpoint
- $v = 0$ at midpoint, $\pm v_{max}$ at ends
- purely resistive impedance = 73Ω
- easily matched to many transmission lines

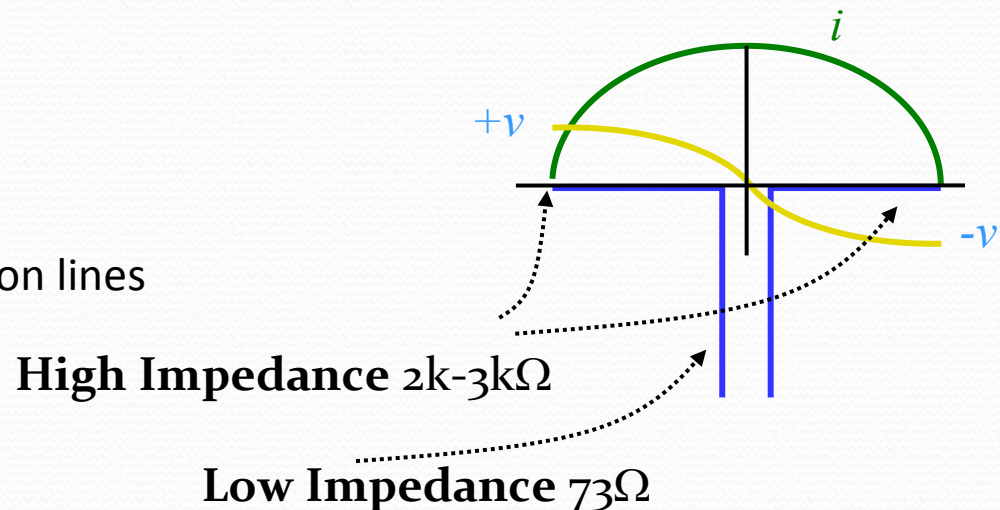

E-field (**E**) & M-field (**B**) used to determine radiation pattern

- **E** goes through antenna ends & spreads out in increasing loops
- **B** is a series of concentric circles centered at midpoint gap

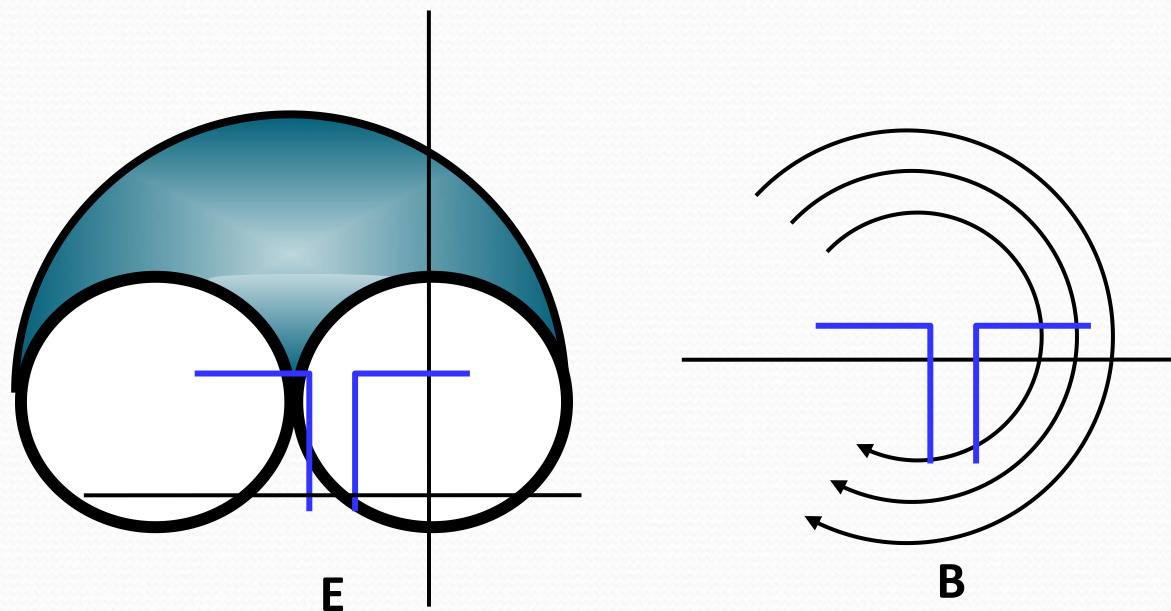

3-dimensional field pattern is **donut shaped**

antenna is shaft through donut center

radiation pattern determined by taking slice of donut

- if antenna is horizontal \rightarrow slice reveals figure 8
- maximum radiation is broadside to antenna's arms

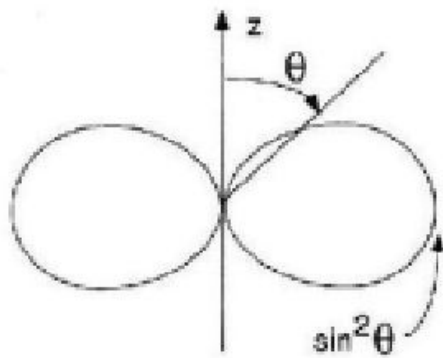

Elevation Pattern

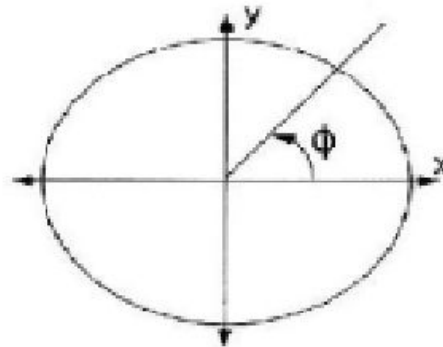

Azimuth Pattern

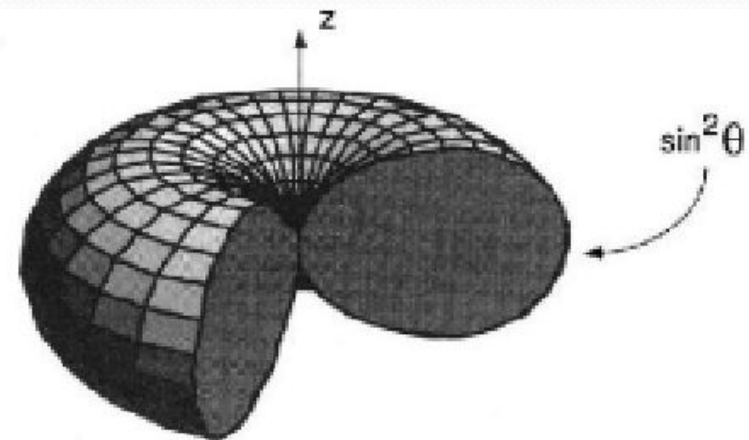

Polar Radiation Pattern

$\frac{1}{2}\lambda$ dipole performance – isotropic reference antenna

- in free space → **beamwidth** = 78°
- **maximum gain** = 2.1dB
- dipole often used as reference antenna
 - feed same signal power through $\frac{1}{2}\lambda$ dipole & test antenna
 - compare field strength in all directions

Actual Construction

(i) propagation velocity in wire < propagation velocity in air

(ii) fields have '**fringe effects**' at end of antenna arms

- affected by capacitance of antenna elements

1st estimate: make real length 5% less than ideal – otherwise introduce reactive parameter

Useful Bandwidth: 5%-15% of f_c

- major factor for determining bandwidth is diameter of conductor
- smaller diameter → narrow bandwidth

Multi-Band Dipole Antennas

use 1 antenna → support several widely separated frequency bands
e.g. *HAM Radio - 3.75MHz-29MHz*

Traps: L, C elements inserted into dipole arms

- arms appear to have different lengths at different frequencies
- traps must be suitable for outdoor use
- 2ndry affects of trap impact effective dipole arm length-adjustable
- not useful over 30MHz

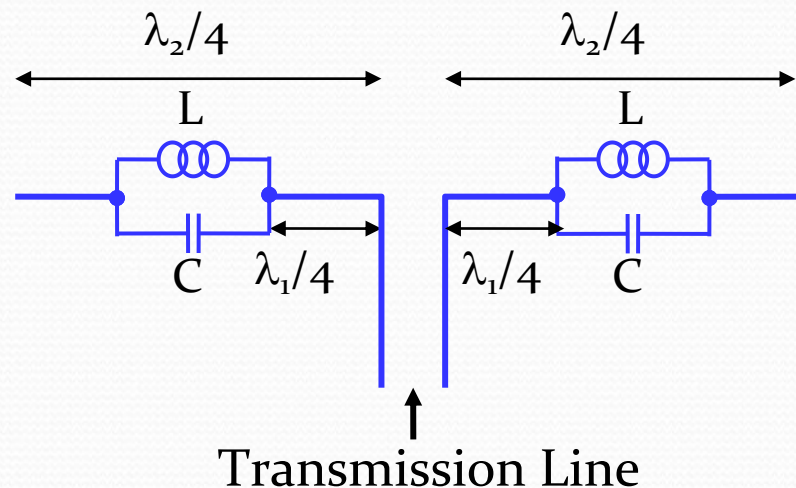

Transmit Receive Switches

- allows use of single antenna for transmit & receive
- alternately connects antenna to transmitter & receiver
- high transmit power must be isolated from high gain receiver
- isolation measured in dB

e.g. 100dB isolation \rightarrow 10W transmit signal \approx 10nW receive signal

Folded Dipole Antenna

- basic $\frac{1}{2}\lambda$ dipole folded to form complete circuit
- core to many advanced antennas
- mechanically more rugged than dipole
- 10% more bandwidth than dipole
- input impedance $\approx 292 \Omega$
- close match to std 300Ω twin lead wire transmission line
- use of different diameter upper & lower arms \rightarrow allows variable impedance

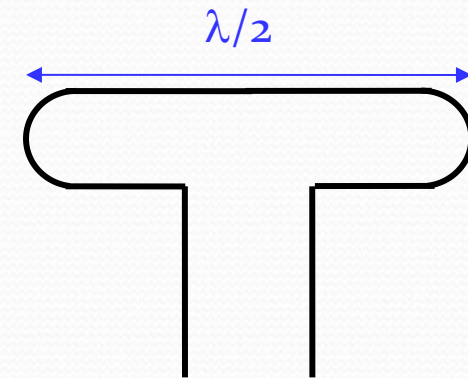

Loop & Patch Antenna – wire bent into loops

Patch Antenna: rectangular conducting area with || ground plane

$$V = k(2\pi f) BAN$$

V = maximum voltage induced in receiver by EM field

B = magnetic field strength flux of EM field

A = area of loop

N = number of turns

f = signal frequency



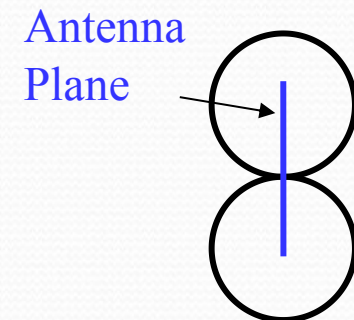
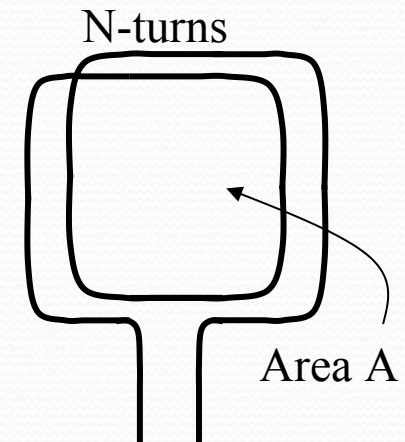







k = physical proportionality factor

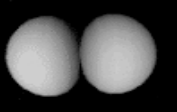
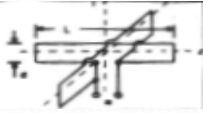
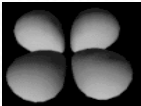

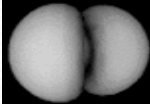
Radiation Pattern

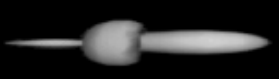
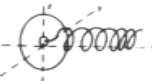
- maximum \perp to center axis through loop
- very low broadside to the loop
- useful for direction finding
 - rotate loop until signal null (minimum) observed
 - transmitter is on either side of loop
 - intersection with 2nd reading pinpoints transmitter

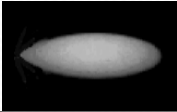
- Loop & Patch Antennas are easy to embed in a product (e.g. pager)
- Broadband antenna - 500k-1600k Hz bandwidth
- Not as efficient as larger antennas

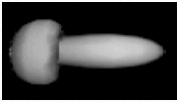
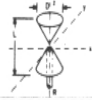
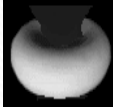
Name	Shape	Gain (over isotropic)	Beamwidth - 3 dB	Radiation Pattern
Isotropic		0 dB	360	
Dipole		2.14 dB	55	
Turnstile		-0.86 dB	50	
Full Wave Loop		3.14 dB	200	
Yagi		7.14 dB	25	
Helical		10.1 dB	30	
Parabolic Dipole		14.7 dB	20	
Horn		15 dB	15	
Biconical Horn		14 dB	360x200	

Radiation Pattern Measurements (1)

- Measured antenna in **receiving** mode
 - The antenna is rotated (or the radiowave source is moved around)
 - The power received (output voltage) is registered vs. the direction angle (azimuth, elevation)
- Measured antenna in **transmitting** mode
 - The antenna is rotated (or the field-strength meter is moved around)
 - The field-strength is registered vs. the direction angle (azimuth, elevation)

Radiation Pattern Measurements (2)

- Laboratory
 - Special test site
 - Open field
 - Anechoic chamber
 - Near-field / Far field calculation
 - Scaling
- Field
 - In-situ measurements
 - Measuring instruments in car, balloon, aeroplane, or helicopter
 - Actual distance / standard distance problem
 - Environmental effects

Electric Field Measurement

- Dipole antenna
- Balance matching
- Impedance matching

Wideband Antennas

- Impedance and radiation pattern of antenna are frequency dependent
- Wideband antennas
 - Conical antennas
 - Equi-angular antennas
 - Log-spiral antennas
 - Log-periodic antennas

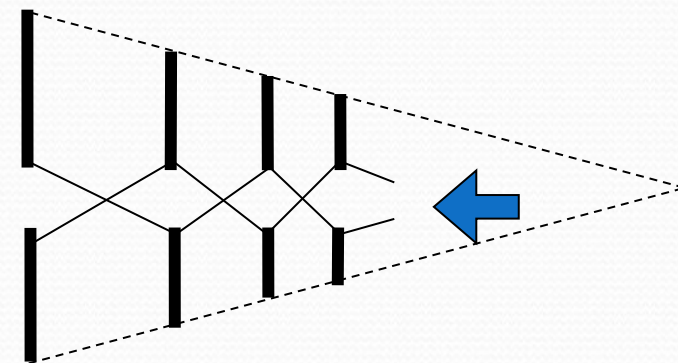
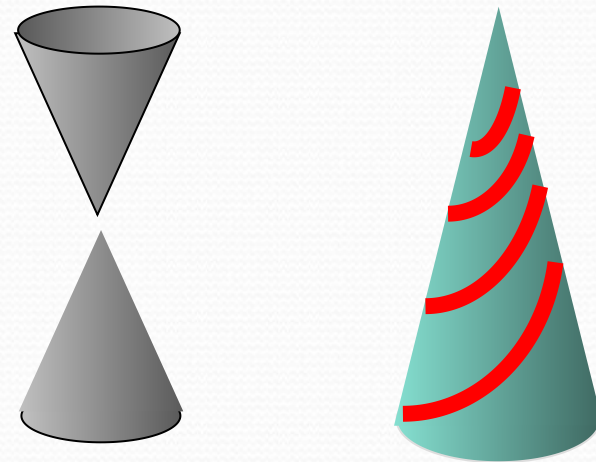

Impedance Matching

- For maximum power transfer the load impedance must match the source impedance:
 - $R_{\text{LOAD}} = R_{\text{SOURCE}}$
 - $X_{\text{LOAD}} = -X_{\text{SOURCE}}$
- Transmission line must terminate in its characteristic impedance
- The balanced/ unbalanced mode-continuity must be assured or a transformer (balun) must be used

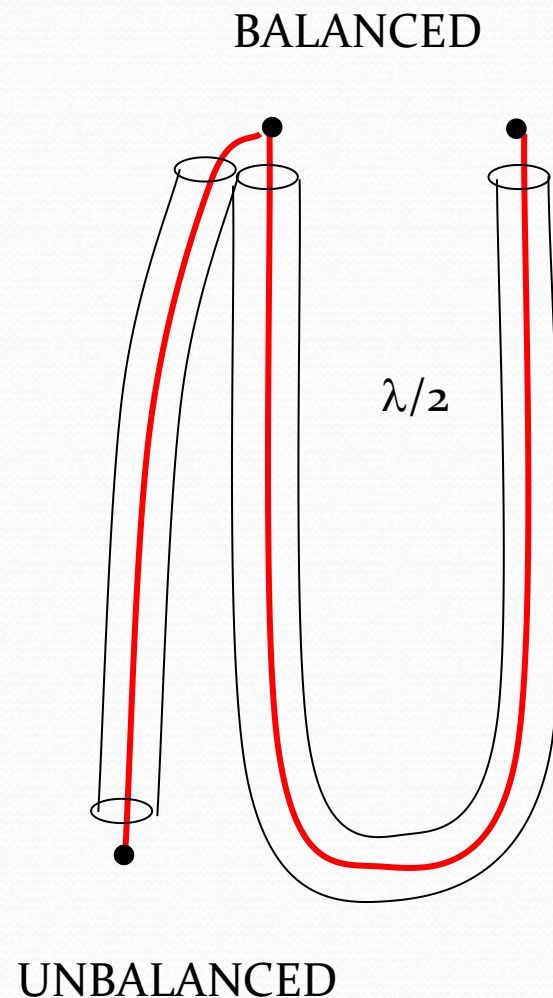

Magnetic Field Measurement

Slot

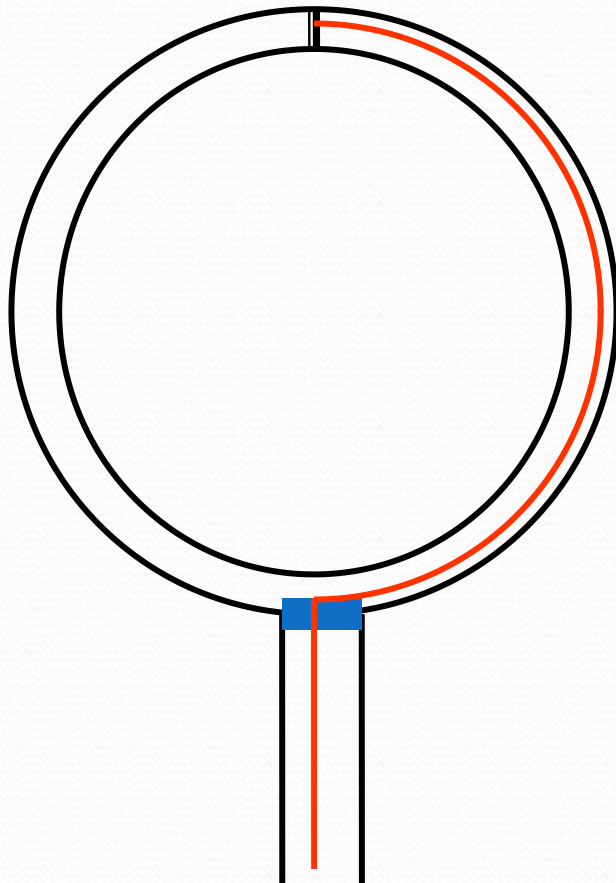

- Loop antenna
- Screen against electric component

Gain Measurements: 2 Antennas

- Reciprocity method
 - 2 identical antennas are used: one as the transmitting antenna and another as receiving antenna
 - The ratio of the power received to power transmitted is measured

$$P_R = P_T G_T G_R \left(\frac{\lambda}{4\pi r} \right)^2$$

$$G_T = G_R = G$$

$$G = \sqrt{\frac{P_R}{P_T} \left(\frac{4\pi r}{\lambda} \right)^2}$$

Gain Measurements: 3 Antennas

- The 3-antenna method can be used to calibrate 3 arbitrary antennas.
- 3 measurements are made, giving 3 equations with 3 unknown gains
- It is the only method applicable to active antennas that cannot be used in transmit mode.

$$P_{12} = P_T G_1 G_2 \left(\frac{\lambda}{4\pi r} \right)^2$$

$$P_{23} = P_T G_2 G_3 \left(\frac{\lambda}{4\pi r} \right)^2$$

$$P_{13} = P_T G_1 G_3 \left(\frac{\lambda}{4\pi r} \right)^2$$

Calibrating Test Antennas (1)

- Simulation of free-space conditions
 - Removing the reflected ray by using absorbers
 - Exploiting directivity (radiation nulls)
 - Practical with vertical polarization
 - Does not require anechoic chamber

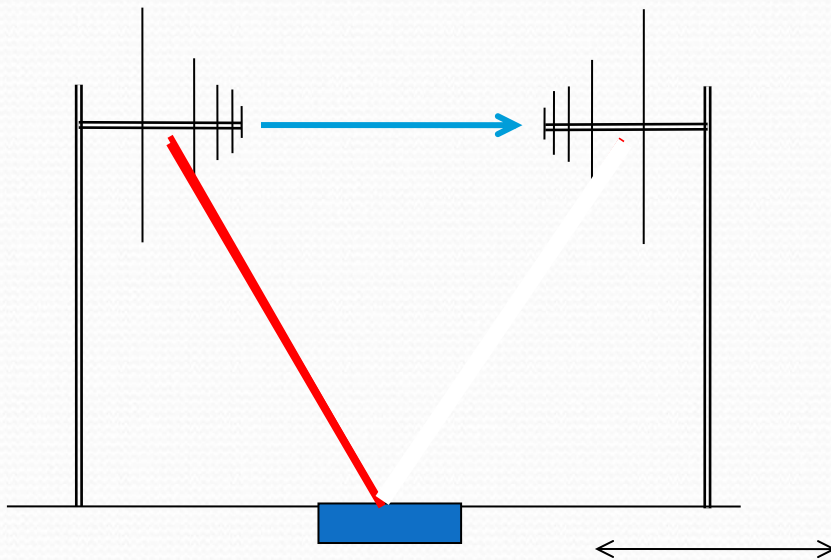

Calibrating Test Antennas (2)

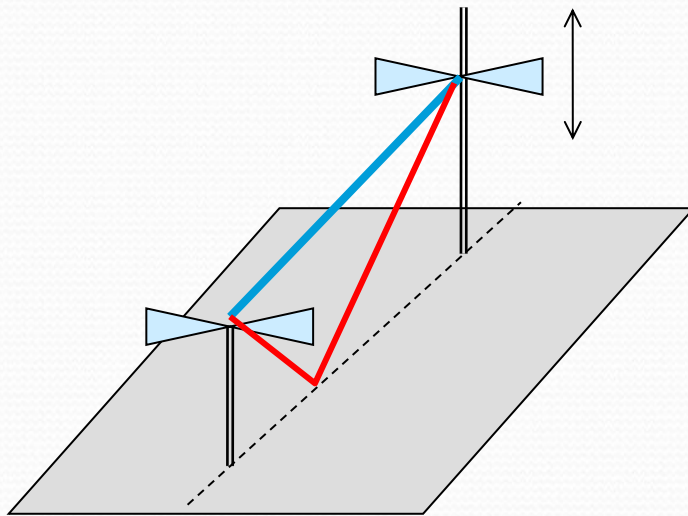

- Exploiting reflection
 - Using conducting surface
 - Adjusting antenna height to receive maximum
 - Practical with horizontal polarization
 - Does not require anechoic chamber

Measurements in the Field

- Relative (comparative) measurements using an auxiliary antenna of known radiation pattern eliminate the distance dependence

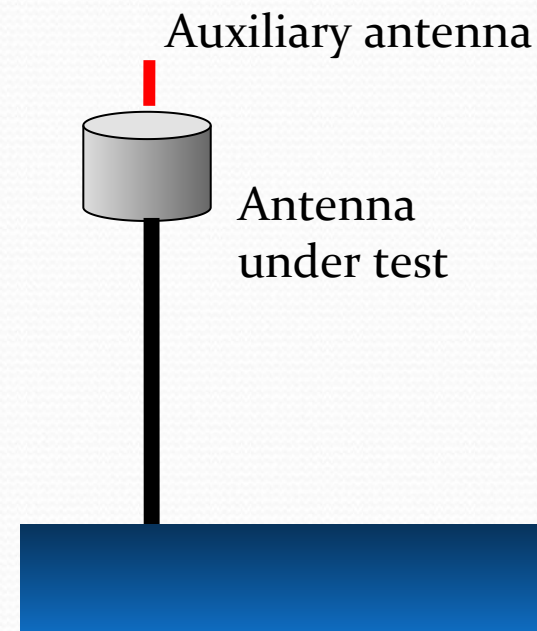

Far-Field Conditions

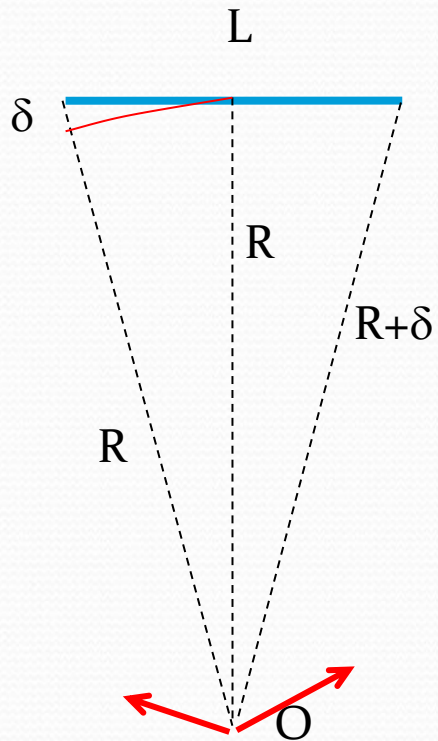

1. $R \gg (\lambda/2\pi)$
2. $R \gg 2L^2/\lambda$

$\delta \ll \lambda/16$ (22,5 deg. instead of 0 deg.)

$$(R+\delta)^2 = R^2 + (L/2)^2$$

$$\underline{R}^2 + 2R\delta + \delta^2 = \underline{R}^2 + (L/2)^2$$

$$2R\delta + \underline{\delta}^2 = (L/2)^2$$

$$R \sim (L/2)^2 / (2\delta) = L^2 / 8\delta$$

$$R \gg (L^2/8) * (16/\lambda)$$

Important when dealing with radiation nulls

Example

- Antenna diameter = 2 m
1. 300 MHz ($\lambda = 1$ m)
 - $\lambda/2\pi = 1/6.28 \sim \underline{0.16}$ m
 - $2L^2/\lambda = 8/1 = \underline{8}$ m
 2. 3000 MHz ($\lambda = 0.1$ m)
 - $\lambda/2\pi = 0.1/6.28 \sim \underline{0.016}$ m
 - $2L^2/\lambda = 8/0.1 = \underline{80}$ m

ANECHOIC CHAMBER MEASUREMENT

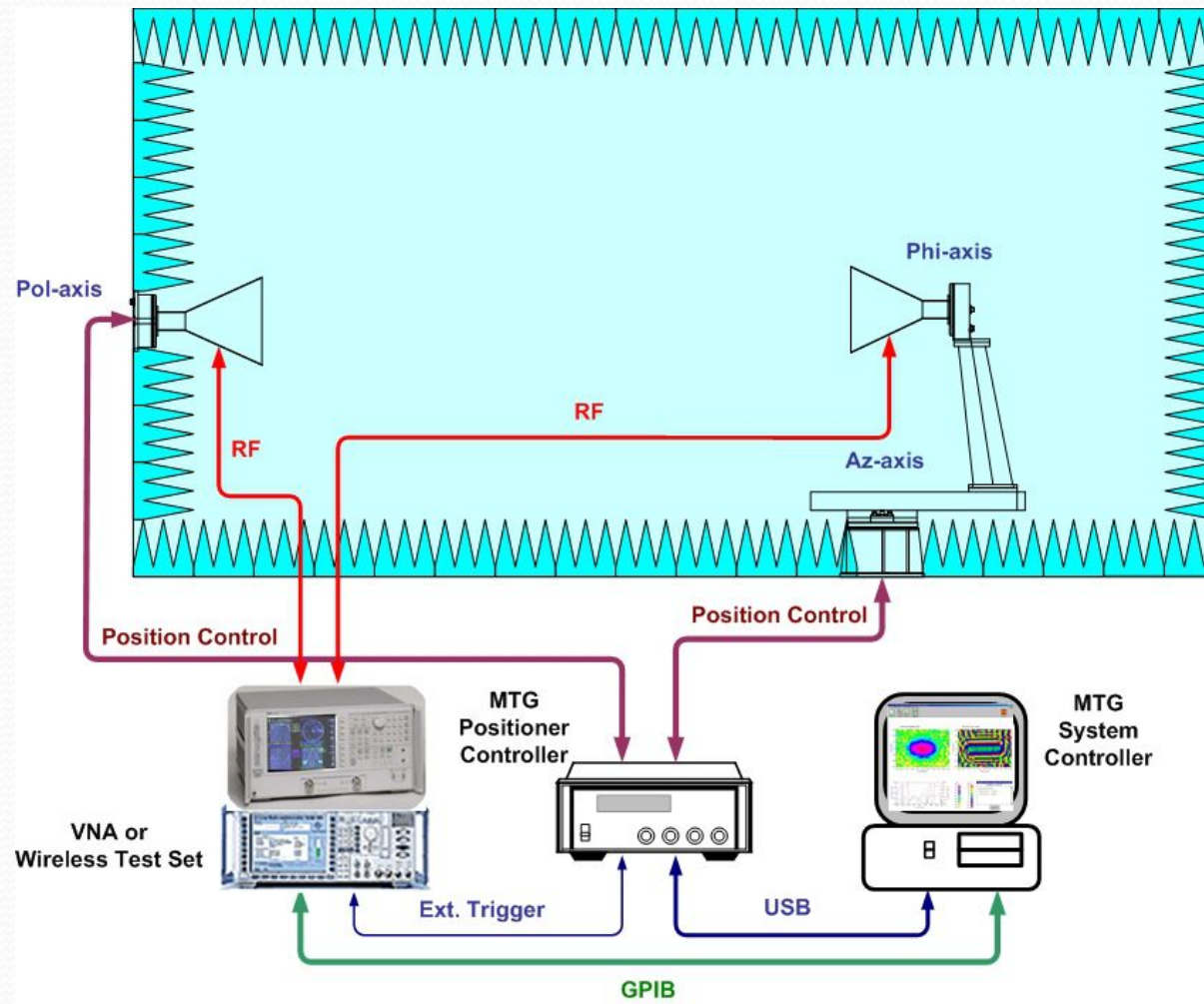

2. OTA Performance Test

- * **CTIA : “Test Plan for Mobile Station Over the Air Performance”**

- March 2003, Revision 2.0
- Method of Measurement for **Radiated RF Power**
and **Receiver Performance**

- * **Contents**

- Test Site Characteristics and Quiet Zone Accuracy – Requirements and Test Method and Procedure
- Substitution Part : Measurement for Path Loss Calibration
- Radiated Power Measurement
- Receiver Performance(Sensitivity) Measurement
- Measurement Uncertainty Analysis

3. Anechoic Chamber

* CTIA's Minimum Requirement

- Quiet Zone Size : Sphere of 300mm Diameter for Measurement
involving Head Phantom
- Minimum Test Length : 1.19m
- +/- 1.0dB Ripple to Guarantee the Uncertainty Level of 2.0dB
including EUT Positioner

3. Anechoic Chamber

* Specifications

Frequency	QZ Diameter *	Transmit Antenna Gain	Receive Antenna Gain	Guaranteed Q. Z. Reflectivity	Guaranteed Q. Z. Ripple
800 MHz	75 cm	6 dBi	7 dBi	-25 dB	+/- 0.49 dB
1 GHz	67 cm	9 dBi	7 dBi	-30 dB	+/- 0.28 dB
1.8 GHz	50 cm	12 dBi	7 dBi	-35 dB	+/- 0.16 dB
3 GHz	38 cm	13 dBi	7 dBi	-42 dB	+/- 0.07 dB
6 GHz	27 cm	15 dBi	7 dBi	-48 dB	+/- 0.04 dB

3. Anechoic Chamber

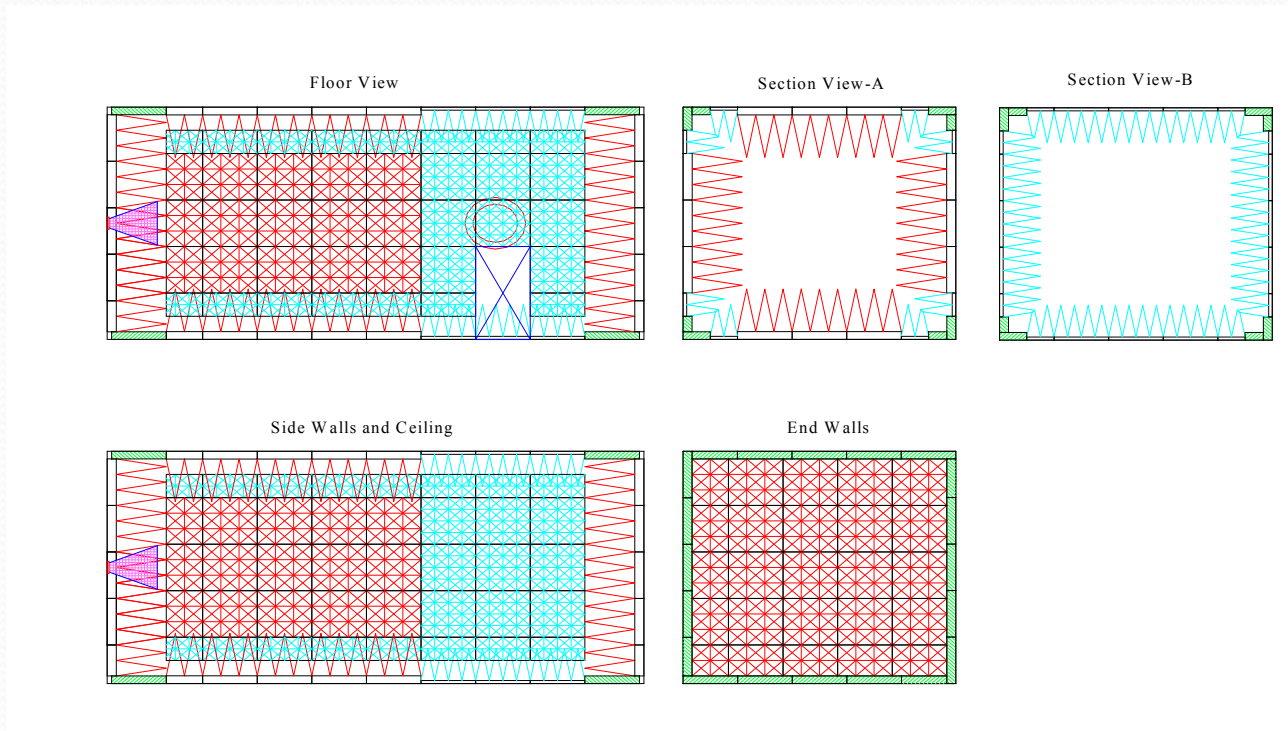

* Absorber Layout Optimization for High Performance Chamber

- Bidirectional Reciprocal Characteristics
- Minimize Reflection Level into Quiet Zone
- Ensure Working Space around EUT Positioner

3. Anechoic Chamber

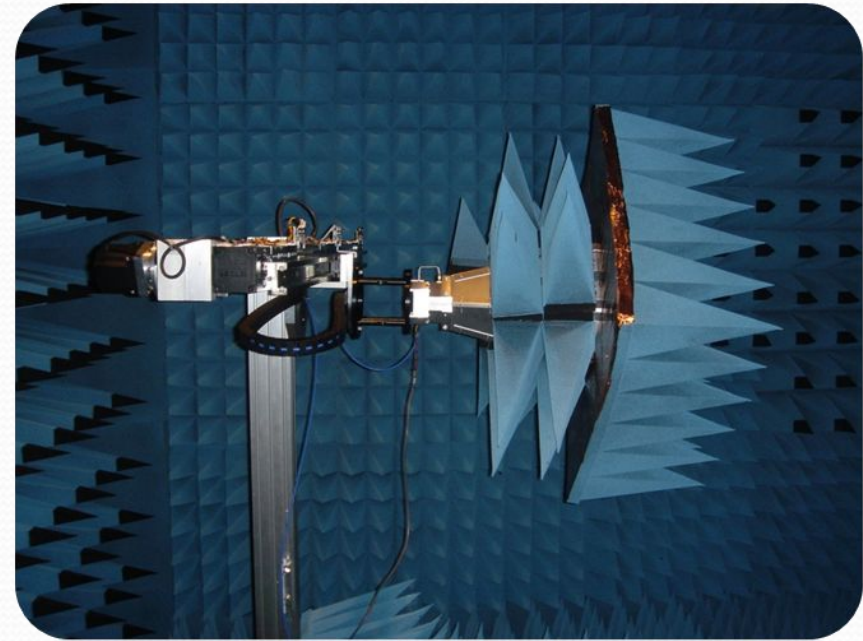
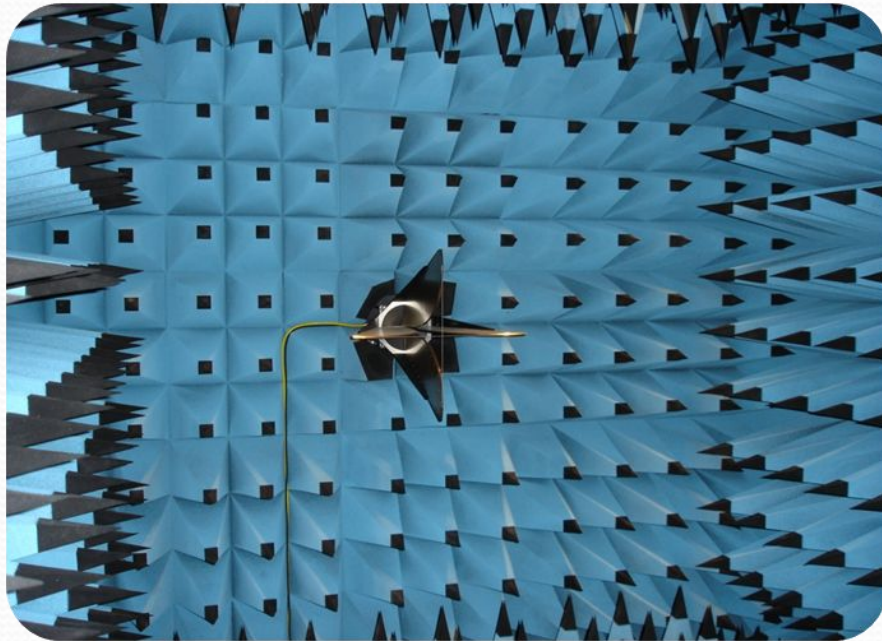

*** Chamber Quiet Zone Test**

- Field-Probing : IEEE-STD-158-1979
- CTIA Requirement : Quiet Zone Ripple Test

4. Measurement Antenna

* **MTG's Optimized Measurement Antenna-QRH-008060**

- Switchable Dual-Pol. Quad-Ridge Antenna System
- Gain is Optimized to Have Linear Slope within Frequency Band of 0.8~6.0GHz
- VSWR is Optimized to be less than 2.0 from 700MHz

* **Path Loss Compensation**

- Space Loss of Range Length 3.0m : -20.5dB/dBsm
- Isotropic Antenna Capture Area : -21.4dBsm @ 1.0GHz,
-27.5dBsm @ 2.0GHz
- Cable Loss and Switch Loss from Base Station Simulator to Antenna : -3.5dB max.
- Total Loss : -45.4dB @ 1GHz, -51.5dB @ 2GHz

* **Gain is Recommended to be at Least 11.5dBi @ 2GHz**

4. Measurement Antenna

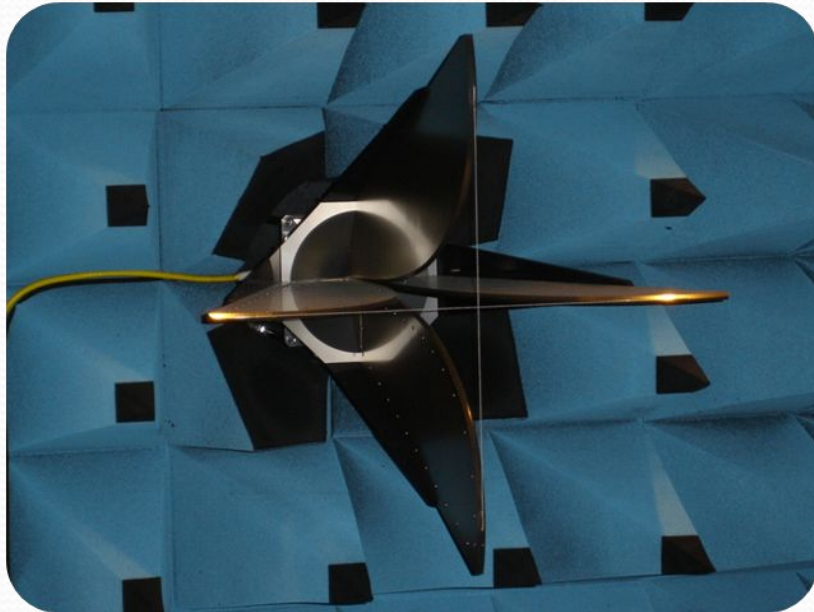

* VSWR and Isolation Characteristics

- Less than 2.0 from 700MHz
- Isolation better than 25dB

4. Measurement Antenna

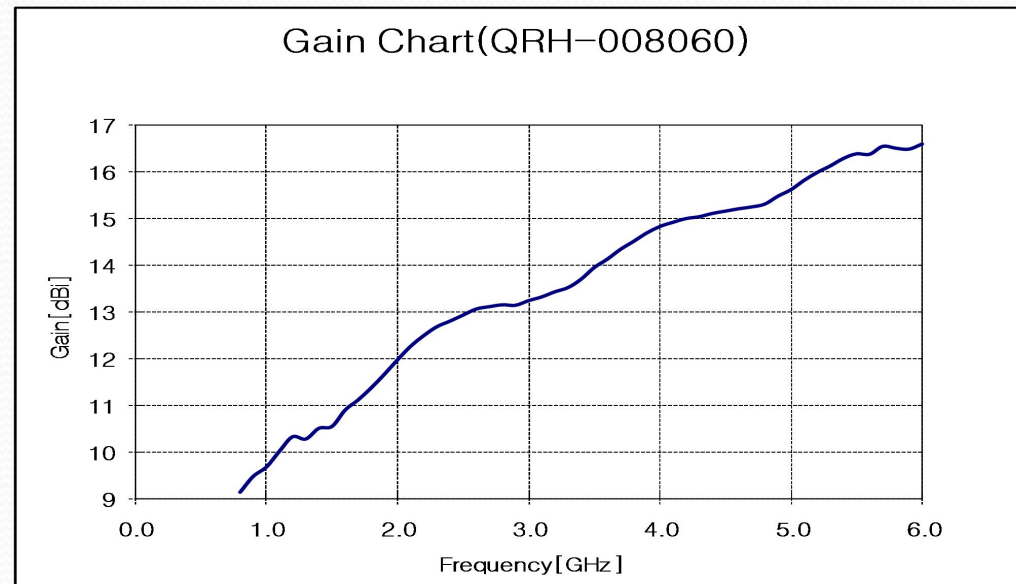

* Optimized Gain Characteristics

- Linear Gain Slope within 0.8~1.2GHz, 1.5~2.3GHz Bands
- Reduce Inter-Channel Differences during TX Power and Sensitivity Measurement

5. Positioners

* High Precision Az Positioner (AP-6209)

- Operating Load : 300kg
- Resolution/Accuracy : Better than 0.01deg
- Speed : up to 90deg/sec
- Rotary Joint(DC~18GHz) and Slip Ring Included

* Transparent 3D EUT Positioner (AP-6917)

- Satisfies CTIA's +/- 1.0dB Ripple Requirement
- Base Linear Slide for to Accommodate Various Kinds of Phantoms/Jigs
- Mast made of Low Dielectric/Low Loss Spectra
- Rotary Joint(DC~18GHz) Included
- Free Space Jig Included

5. Positioners



AZ Positioner (AP-6209)

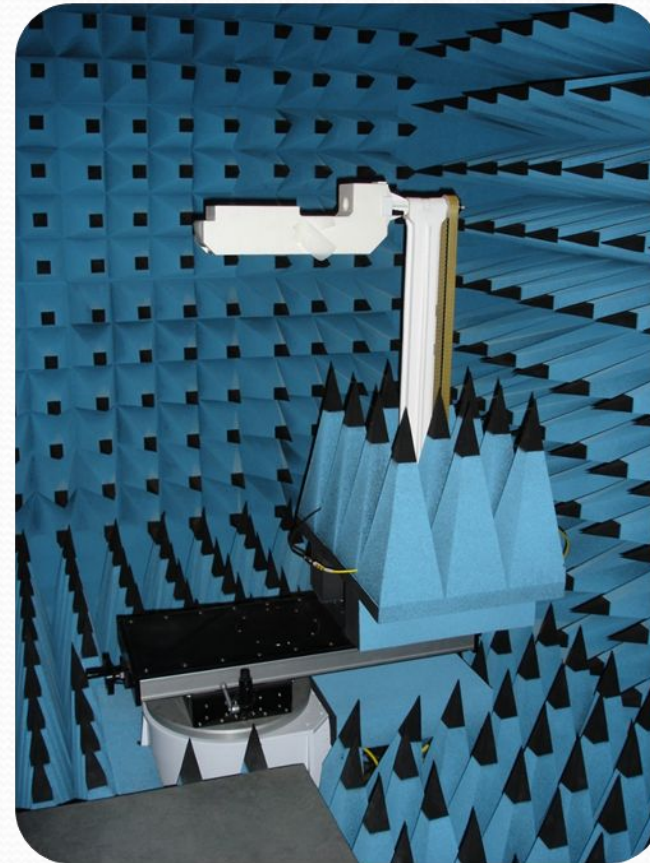

(AP-6209) + (AP-6917)

5. Positioners

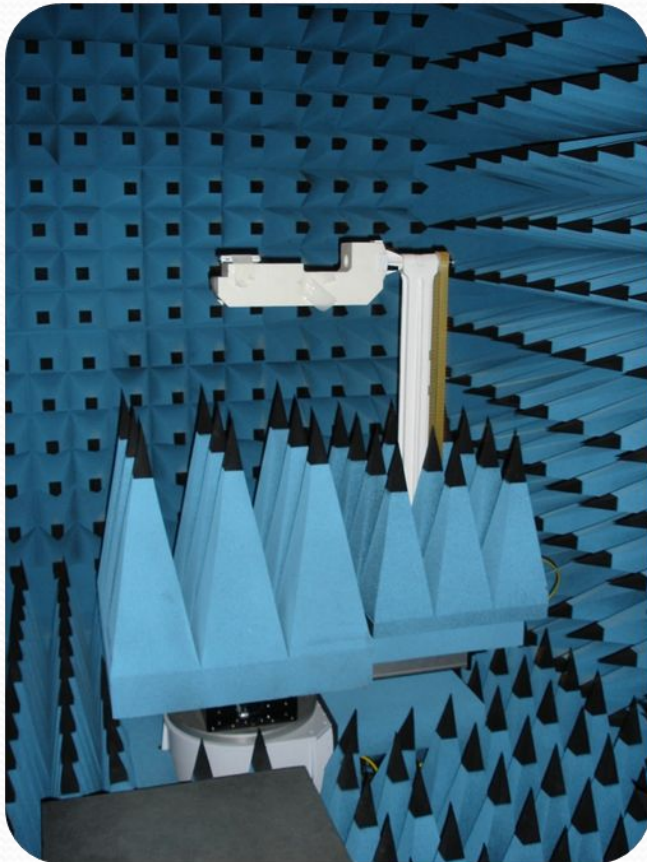

Active Test (TRP/TIS)

5. Positioners

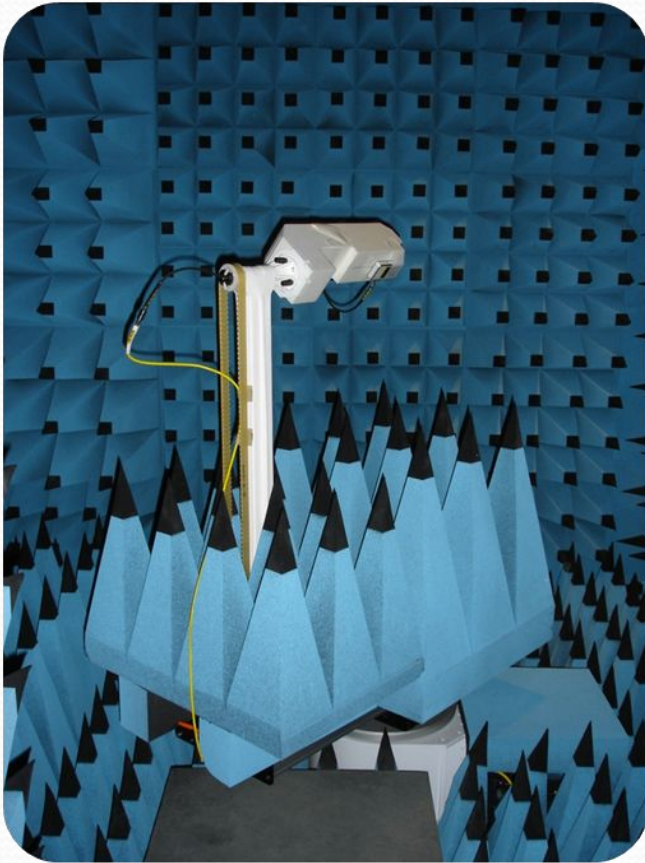

Passive Test

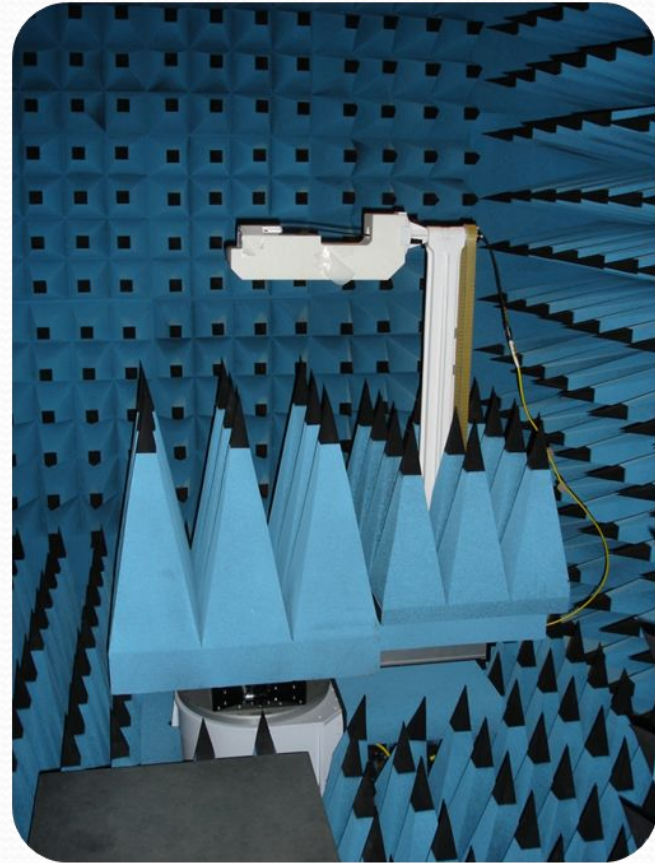

Ripple Test

PROPAGATION

- Radio waves-used for both indoor and outdoor communications because of their ability to pass through buildings and travel long distances.
- key features:
 - **Omni directional** in nature
 - frequency of the radio wave determines many of the characteristics of the transmission.
 - At low frequencies, the waves can pass through obstacles easily.
 - higher frequency waves are more prone to absorption by rain drops and they get reflected by obstacles.
 - Due to the long transmission range of the radio waves, interference between transmissions is a problem that needs to be addressed.

- VLF, LF and MF bands the propagation of waves, also called as **ground waves** follow the curvature of the earth.
- used for **low bandwidth transmissions** such as Amplitude Modulation (**AM**) radio broadcasting.
- A powerful **sky wave may be reflected several times between the Earth and the ionosphere.**
- Sky waves are **used by amateur ham radio operators and for military communication.**

Radio Wave Propagation

- we use wireless electromagnetic waves as the channel.
- The antennas of different specifications can be used for these purposes.
- The sizes of these antennas depend upon the bandwidth and frequency of the signal to be transmitted.
- The mode of propagation of electromagnetic waves in the atmosphere and in free space may be divided in to the following three categories:
 - Line of sight (LOS) propagation
 - Ground wave propagation
 - Sky wave propagation

Line of Sight (LOS) Propagation

- the wave travels a minimum distance of sight.
- Which means it travels to the distance up to which a naked eye can see.

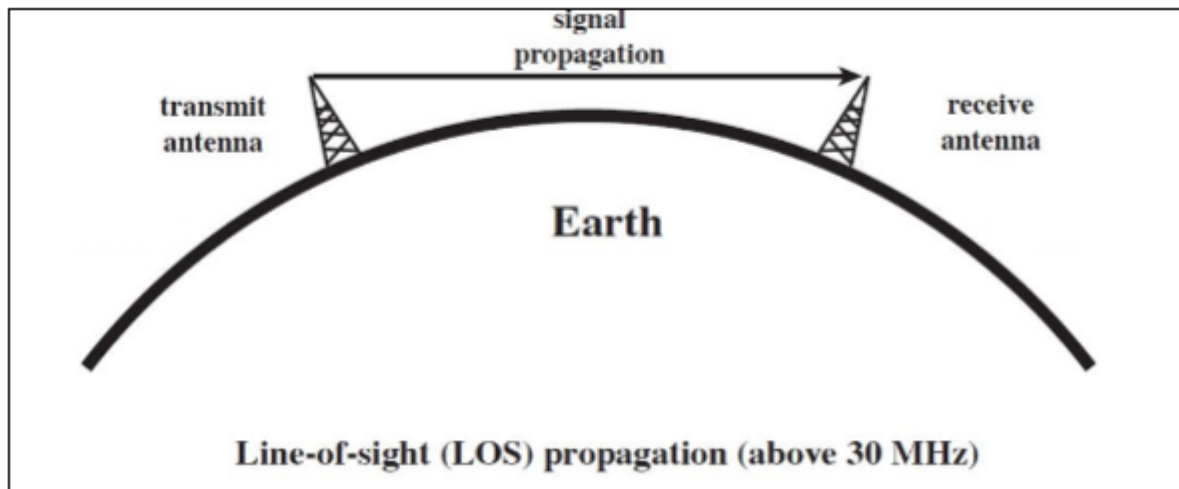

- The line-of-sight propagation **will not be smooth if there any obstacle occurs in its transmission path.**
- As the signal can travel only to **lesser distances in this mode**, this transmission is used for **infrared** or **microwave transmissions.**
- Above 30 MHz neither ground nor sky wave propagation operates.
- Transmitting and receiving antennas must be within line of sight.

Line-of-Sight Equations

Line-of-Sight Equations

- Optical line of sight

$$d = 3.57\sqrt{h}$$

- Effective, or radio, line of sight

$$d = 3.57\sqrt{Kh}$$

- d = distance between antenna and horizon (km)
- h = antenna height (m) (altitude relative to a receiver at the sea level)
- K = adjustment factor to account for refraction caused by atmospheric layers; rule of thumb $K = 4/3$

11

Maximum distance between two antennas for LOS propagation:

$$3.57 \left(\sqrt{K h_1} + \sqrt{K h_2} \right)$$

- h_1 = height of antenna one
- h_2 = height of antenna two

Ground Wave Propagation

- wave follows the contour of earth.
- Such a wave is called as direct wave.
- The wave sometimes bends due to the Earth's magnetic field and gets reflected to the receiver.
- Such a wave can be termed as reflected wave.
- The wave when propagates through the Earth's atmosphere is known as **Ground Wave**.

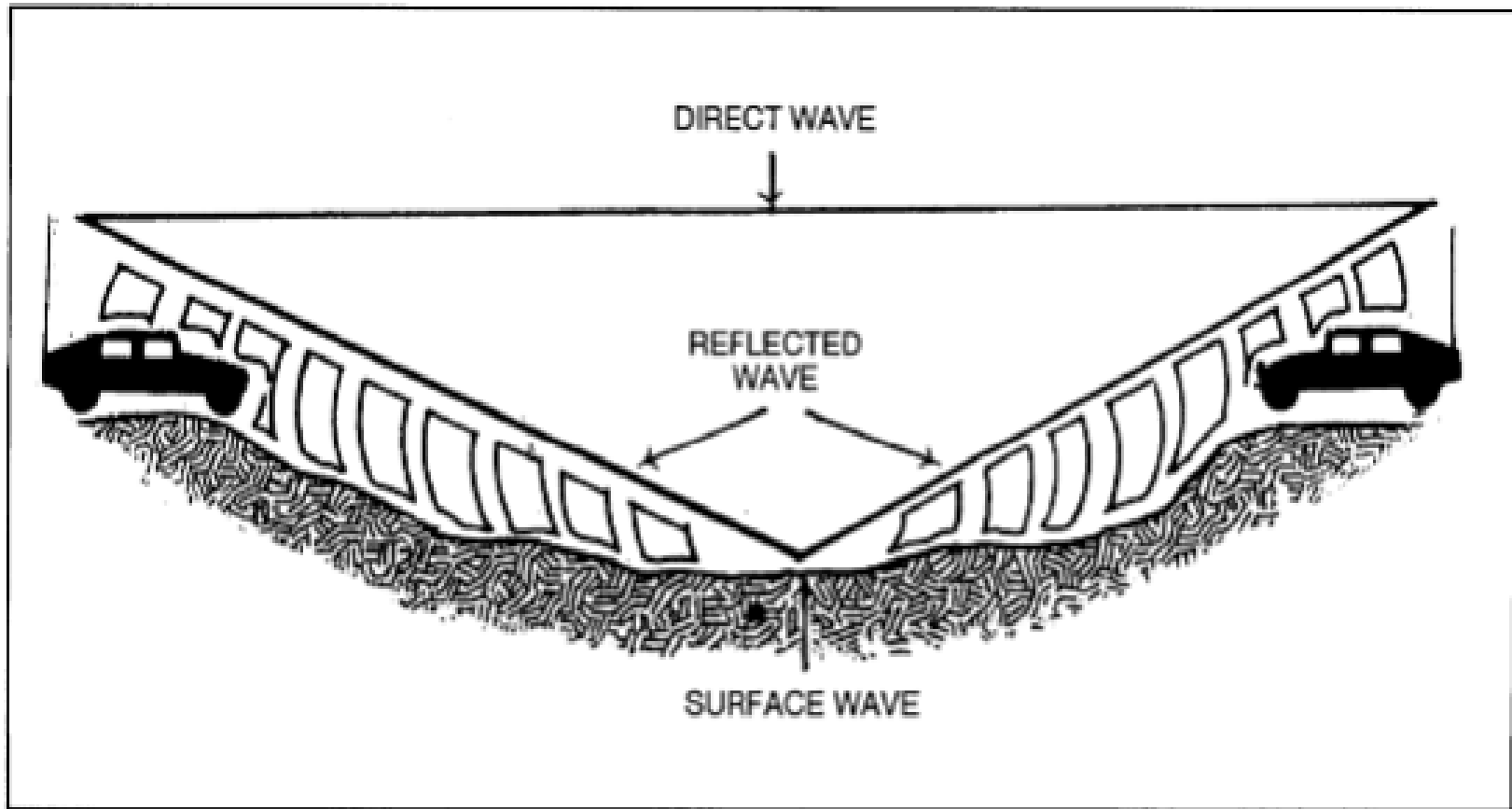
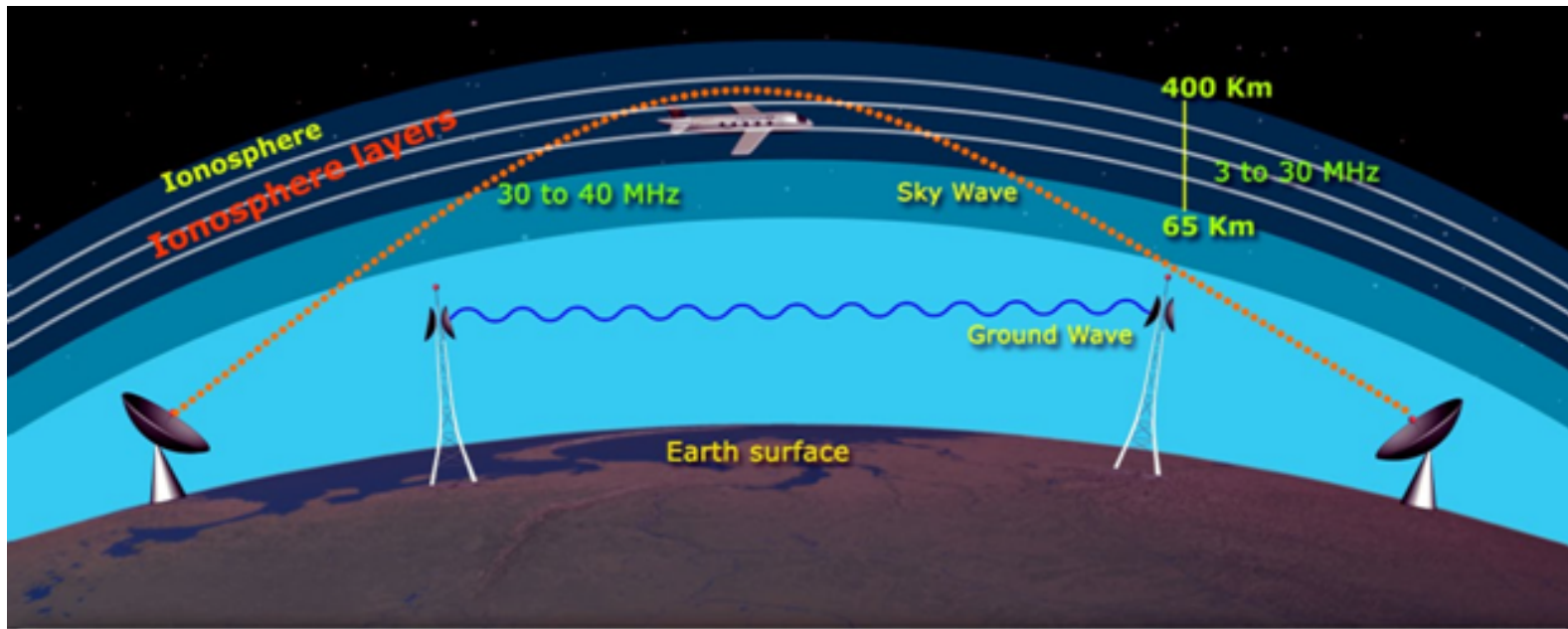
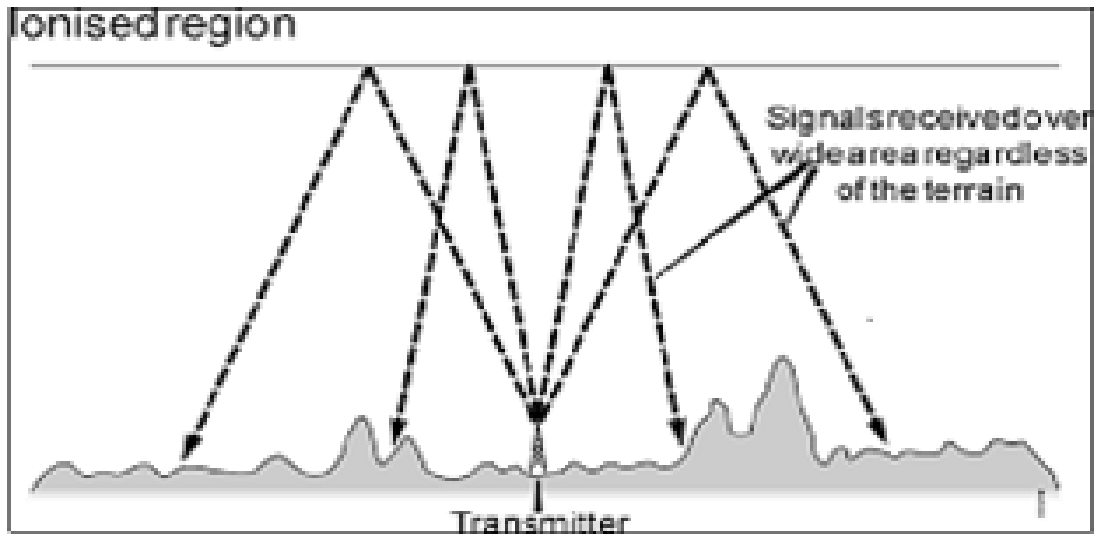

Figure D-2. Components of ground wave.

- The direct wave and reflected wave together contribute the signal at the receiver station.
- When the wave finally reaches the receiver, the lags are cancelled out.
- In addition, the signal is filtered to avoid distortion and amplified for clear output.

Sky Wave Propagation

- when the wave has to travel a longer distance.
- Here the wave is projected onto the sky and it is again reflected back onto the earth.
- Here the waves are shown to be transmitted from one place and where it is received by many receivers.
- Hence, it is an example of broadcasting.



- waves, which are transmitted from the transmitter antenna, are reflected from the ionosphere.
- It consists of several layers of charged particles ranging in altitude from 30- 250 miles above the surface of the earth.
- Such a travel of the wave from transmitter to the ionosphere and from there to the receiver on Earth is known as **Sky Wave Propagation**.
- Ionosphere is the ionized layer around the Earth's atmosphere, which is suitable for sky wave propagation.

- Earth's atmosphere has several layers.
- These layers play an important role in the wireless communication.
- These are mainly classified into three layers.

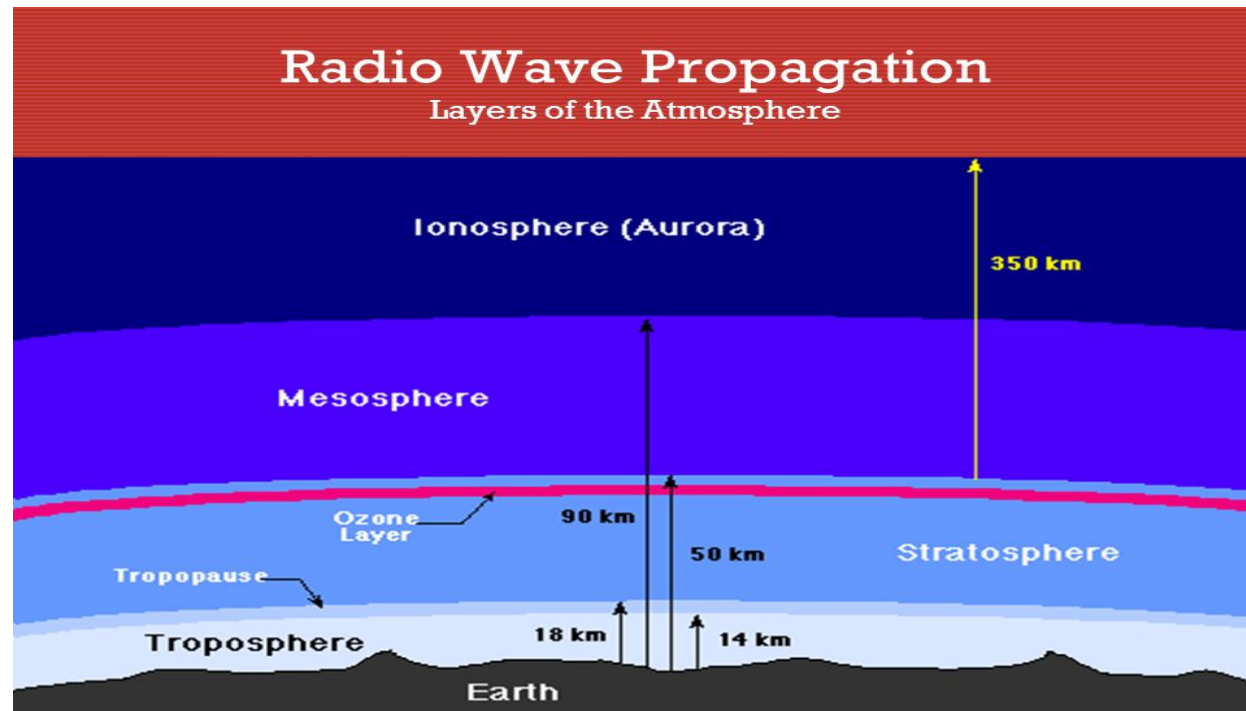

- **Troposphere**
 - This is the layer of the earth,
 - which lies just **above the ground**.
 - The **ground wave propagation** and **LOS propagation** take place here.
- **Stratosphere**
 - This is the layer of the earth, which **lies above Troposphere**.
 - The **birds fly in this region**.
 - The airplanes travel in this region.
 - **Ozone layer** is also present in this region.
 - The ground wave propagation and LOS propagation takes place here.
- **Ionosphere**
 - This is the **upper layer of the Earth's atmosphere**, where ionization is appreciable.
 - The **energy radiated by the Sun**, not only heats this region, but also **produces positive and negative ions**.
 - Since the Sun constantly radiates UV rays and air pressure is low, this layer encourages ionization of particles.

Importance of Ionosphere

- The ionosphere layer is a very important consideration in the phase of wave propagation because of the following reasons:
 - The layer below ionosphere has higher amount of air particles and lower UV radiation. Due to this, more collisions occur and ionization of particles is minimum and not constant.
 - The layer above ionosphere has very low amount of air particles and density of ionization is also quite low. Hence, ionization is not proper.
 - The ionosphere has good composition of UV radiation and average air density that does not affect the ionization. Hence, this layer has most influence on the Sky wave propagation.

- The ionosphere has different gases with different pressures.
- Different ionizing agents ionize these at different heights.
- The number of layers, their heights, and the amount of sky wave that can be bent will vary from day to day, month to month and year to year.
- For each such layer, there is a frequency, above which if the wave is sent upward vertically, it penetrates through the layer.

- The function of these layers depends upon the time of the day, i.e., day time and night time.
- There are three principal layers- E, F1 and F2 during day time.
- There is another layer called D layer, which lies below E layer.
- This layer is at 50 to 90kms above the troposphere.

- This **D layer** is responsible for the day time **attenuation of HF waves**.
- **During night time**, this D layer almost vanishes out and the **F1 and F2 layers combine together to form F layer**.
- Hence, there are **only two layers E and F present at the night time**.

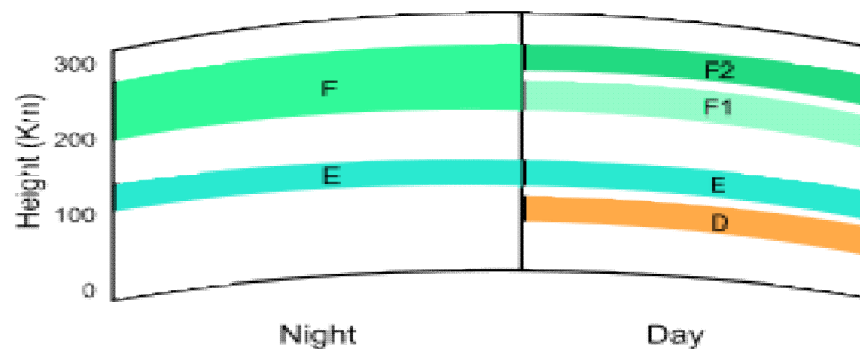

Virtual Height

- When a wave is refracted, it is bent down gradually, but not sharply.
- However, the path of incident wave and reflected wave are same if it is reflected from a surface located at a greater height of this layer.
- Such a greater height is termed as virtual height.
- the **virtual height** (height of wave, supposed to be reflected) and **actual height** (the refracted height).
- If the virtual height is known, the angle of incidence can be found.

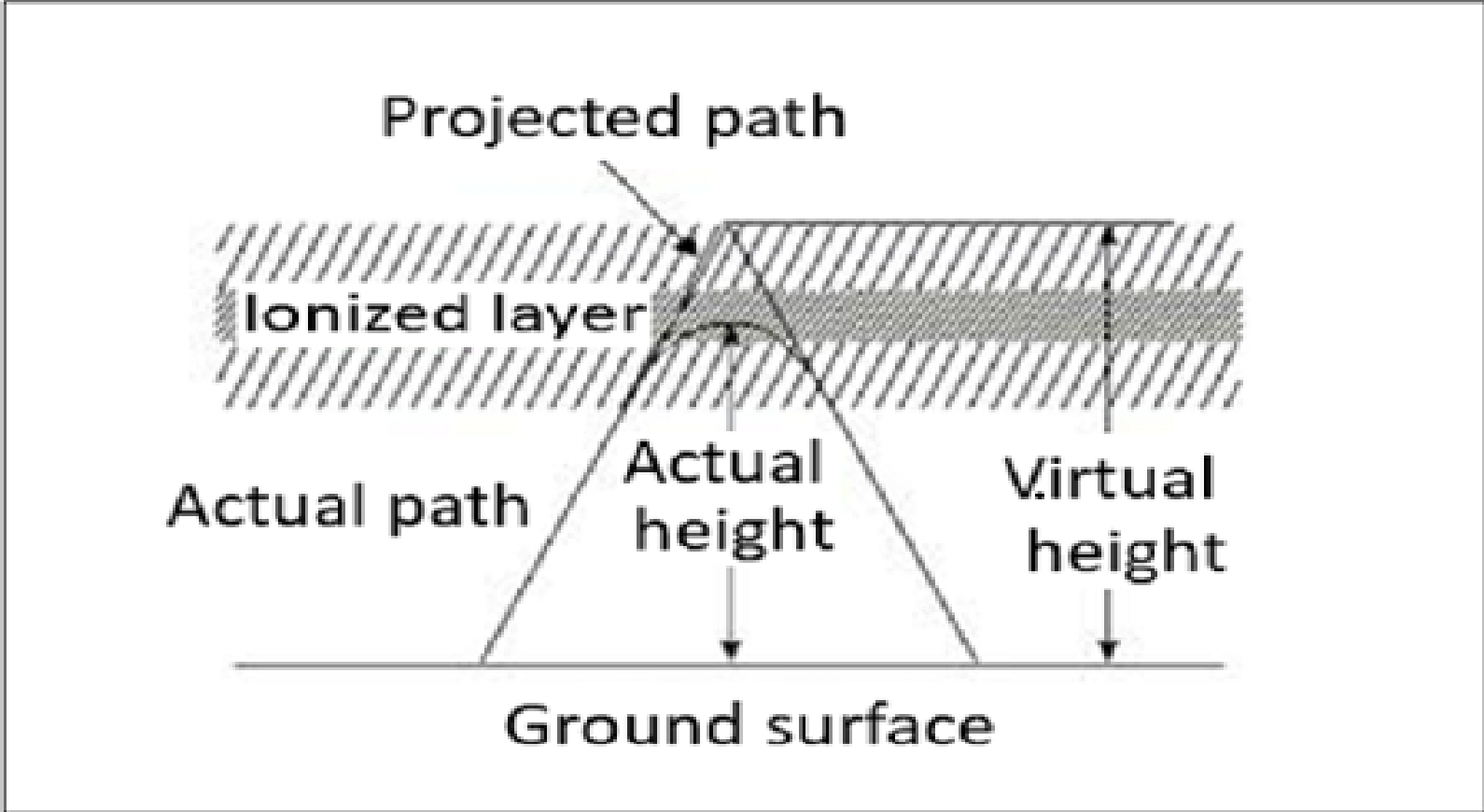

Critical Frequency (f_c)

- Critical frequency for a layer determines the highest frequency that will be returned down to the earth by that layer, after having been beamed by the transmitter, straight up into the sky.
- The rate of ionization density, when changed conveniently through the layers, the wave will be bent downwards.
- The maximum frequency that gets bent and reaches the receiver station with minimum attenuation can be termed as **critical frequency**. This is denoted by f_c .

Multi-Path Propagation

- For the frequencies above 30 MHz, the sky wave propagation exists.
- Signal multipath is the common problem for the propagation of electromagnetic waves going through Sky wave.
- The wave, which is reflected from the ionosphere, can be called as a **hop** or **skip**.
- There can be a number of hops for the signal as it may move back and forth from the ionosphere and earth surface many times.
- Such a movement of signal can be termed as **multipath**.

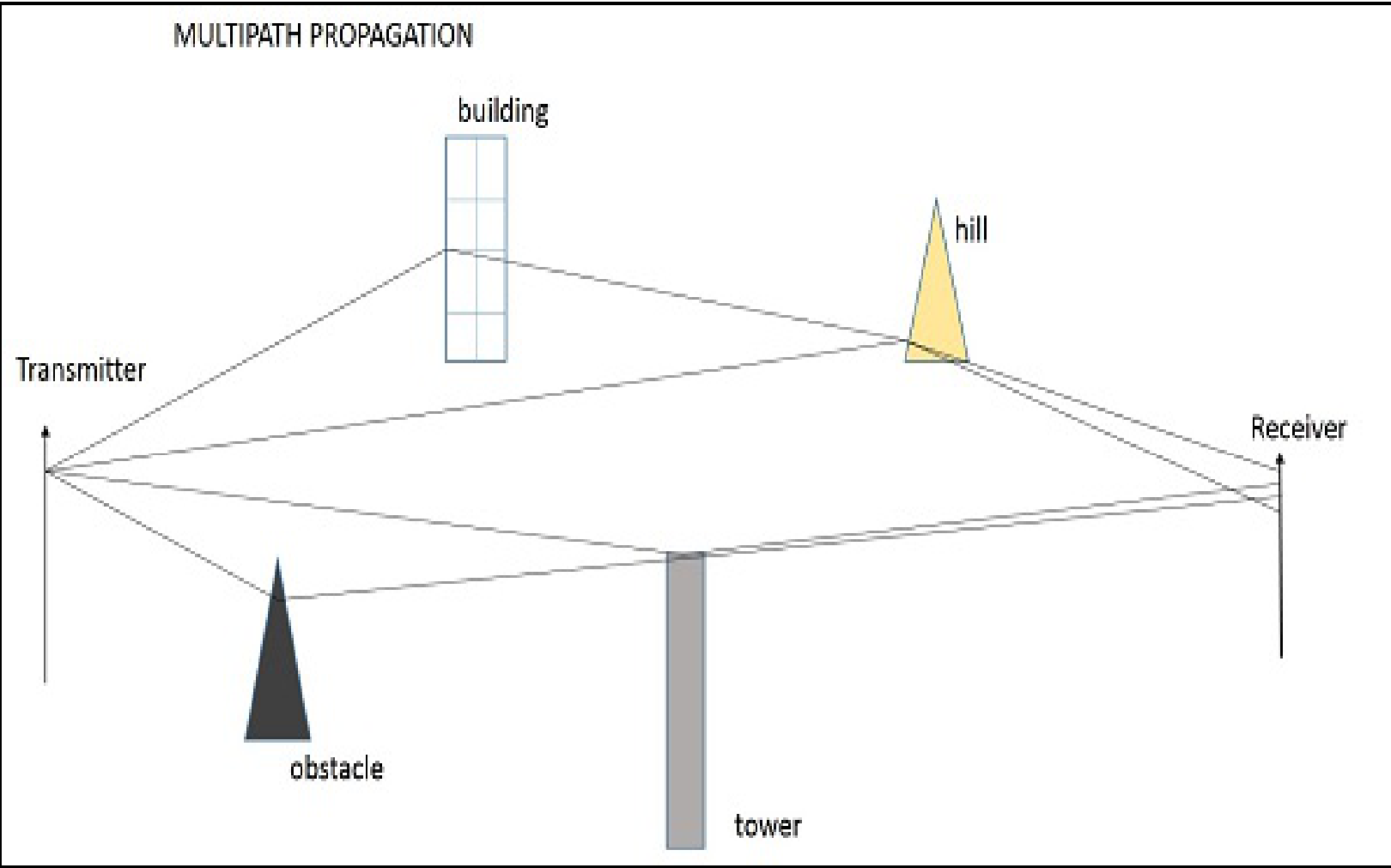

- Multipath propagation is a term, which describes the multiple paths a signal travels to reach the destination.
- These paths include a number of hops.
- The paths may be the results of reflection, refraction or even diffraction.
- Finally, when the signal from such different paths gets to the receiver, it carries propagation delay, additional noise, phase differences etc., which decrease the quality of the received output.

Fading

- The decrease in the quality of the signal can be termed as **fading**.
- This happens because of atmospheric effects or reflections due to multipath.
- Fading refers to the variation of the signal strength with respect to time/distance.
- It is widely prevalent in wireless transmissions.
- The most common causes of fading in the wireless environment are multipath propagation and mobility (of objects as well as the communicating devices).

Skip Distance

- The measurable distance on the surface of the Earth from transmitter to receiver, where the signal reflected from the ionosphere can reach the receiver with minimum hops or skips, is known as **skip distance**.

Maximum Usable Frequency (MUF)

- The **Maximum Usable Frequency (MUF)** is the highest frequency delivered by the transmitter regardless of the power of the transmitter.
- The highest frequency, which is reflected from the ionosphere to the receiver is called as **critical frequency, f_c** .

$$\text{MUF} = \frac{\text{critical frequency}}{\cos \theta}$$

Where,

MUF = Maximum Usable Frequency

θ = Angle of Incidence

